

# METAL FILM PRECISION MELF RESISTOR

## AEC-Q200 QUALIFIED TYPE SMA-Q SERIES

### INTRODUCTION

TE Connectivity (TE) is pleased to introduce the new SMA-Q series, a metal film precision MELF resistor with SMD enabled structure, tight tolerance, and low TCR. A sister to our SMA-A series, the SMA-Q series is AEC-Q200 qualified and benefits from an improved coating which gives much better protection from humidity. It is lead free and RoHS compliant and comes in three sizes and six power ratings up to 1W.

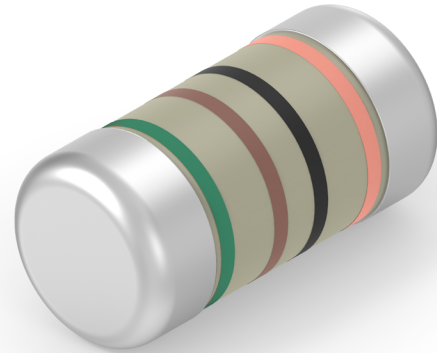

### FEATURES

- Thin film technology
- AEC-Q200 qualified
- Excellent overall stability
- Sn termination on the Ni barrier layer
- Tight tolerance down to  $\pm 0.1\%$
- Extremely low TCR down to  $\pm 5$  ppm/ $^{\circ}\text{C}$
- High power rating up to 1 Watts
- SMD enabled structure
- Lead-Free and RoHS compliant
- Moisture sensitivity level - MSL1

### APPLICATIONS

- Automotive
- Industrial
- Telecommunication
- Medical Equipment
- Measurement/Testing Equipment

### ELECTRICAL CHARACTERISTICS

Description	SMA-Q 0102		SMA-Q 0204		SMA-Q 0207	
	Standard	High Power	Standard	High Power	Standard	High Power
Resistance range	1 $\Omega$ -1M $\Omega$ ; 0 $\Omega$		0.1 $\Omega$ -10M $\Omega$ ; 0 $\Omega$		0.1 $\Omega$ -10M $\Omega$ ; 0 $\Omega$	
Resistance tolerance	See below					
Temperature coefficient	See below					
<b>Operation mode</b>	<b>Standard</b>	<b>High Power</b>	<b>Standard</b>	<b>High Power</b>	<b>Standard</b>	<b>High Power</b>
Power Rating @70 $^{\circ}\text{C}$ (P70)	0.2W	0.3W	0.25W	0.4W	0.5W	1W
Operating voltage Umax	200V	200V	200V	200V	300V	350V
Operating temperature range	-55 $^{\circ}\text{C}$ -155 $^{\circ}\text{C}$ 5PPM -55 $^{\circ}\text{C}$ -125 $^{\circ}\text{C}$					
Max. resistance change at P70 for resistance range, $\Delta R/R$ max., after 1000 h	10 $\Omega$ -332K $\Omega$ : $\pm(0.25\%+0.01\Omega)$ <10 $\Omega$ & >332K $\Omega$ : $\pm(0.5\%+0.01\Omega)$ 0102: $\pm(0.5\%+0.01\Omega)$					

# METAL FILM PRECISION MELF RESISTOR

AEC-Q200 Qualified Type SMA-Q Series

## CONSTRUCTION

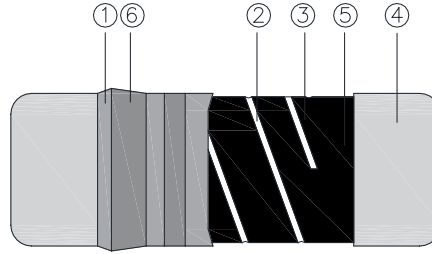

①	Insulation coating	④	Electrode cap
②	Trimming line	⑤	Resistor layer
③	Ceramic rod	⑥	Marking

## DIMENSIONS

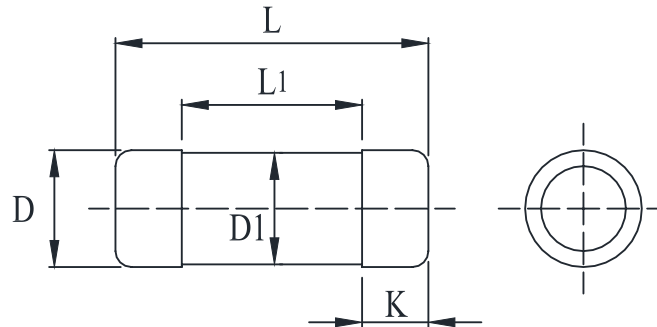

Type	L (mm)	L <sub>1</sub> min. (mm)	ΦD (mm)	ΦD <sub>1</sub> (mm)	K (mm)	Weight 1,000EA (g)
SMA-Q 0102	2.20±0.1	1.1	1.10±0.1	D +0/-0.15	0.45±0.05	7.7
SMA-Q 0204	3.50±0.2	1.7	1.40±0.15	D +0/-0.2	0.8±0.1	18.7
SMA-Q 0207	5.90±0.2	2.9	2.20±0.2	D +0/-0.2	1.3±0.1	80.9

## RECOMMENDED LAND PATTERN

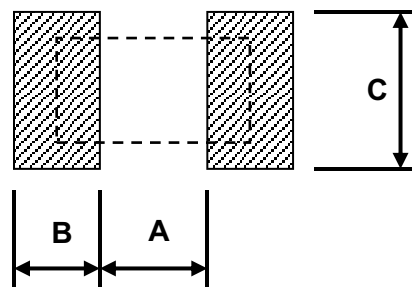

Type	A (mm)	B (mm)	C (mm)
SMA-Q 0102	1.0	0.8	1.5
SMA-Q 0204	1.6	1.2	1.6
SMA-Q 0207	3.0	1.7	2.4

# METAL FILM PRECISION MELF RESISTOR

AEC-Q200 Qualified Type SMA-Q Series

## SOLDERING CONDITION

Reflow Soldering (Ref. IPC/JEDEC J-STD-020 & J-SD-002)

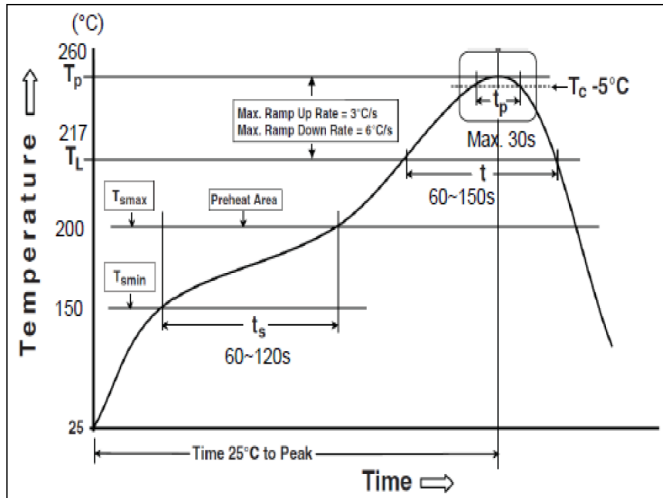

Reflow Profiles	
Profile Feature	Pb-Free Assembly
Preheat	
Min. temperature ( $T_s$ min)	150°C
Max. temperature ( $T_s$ max)	200°C
Preheating time ( $t_s$ ) from ( $T_s$ min to $T_s$ max)	60-120 seconds
Ramp-up rate ( $T_L$ to $T_p$ )	3°C/second max.
Liquidous temperature ( $T_L$ )	217°C
Time ( $T_L$ ) maintained above $T_L$	60-150 seconds
Min. peak temperature ( $T_p$ min)	235°C
Max. peak temperature ( $T_p$ max)	260°C
Time ( $t_p$ ) within 5°C of the specified classification temperature ( $T_c$ )	30 seconds max.
Ramp-down rate ( $T_p$ to $T_L$ )	6°C/seconds max.
Time 25°C to peak temperature	8 minutes max.

## DERATING CURVE

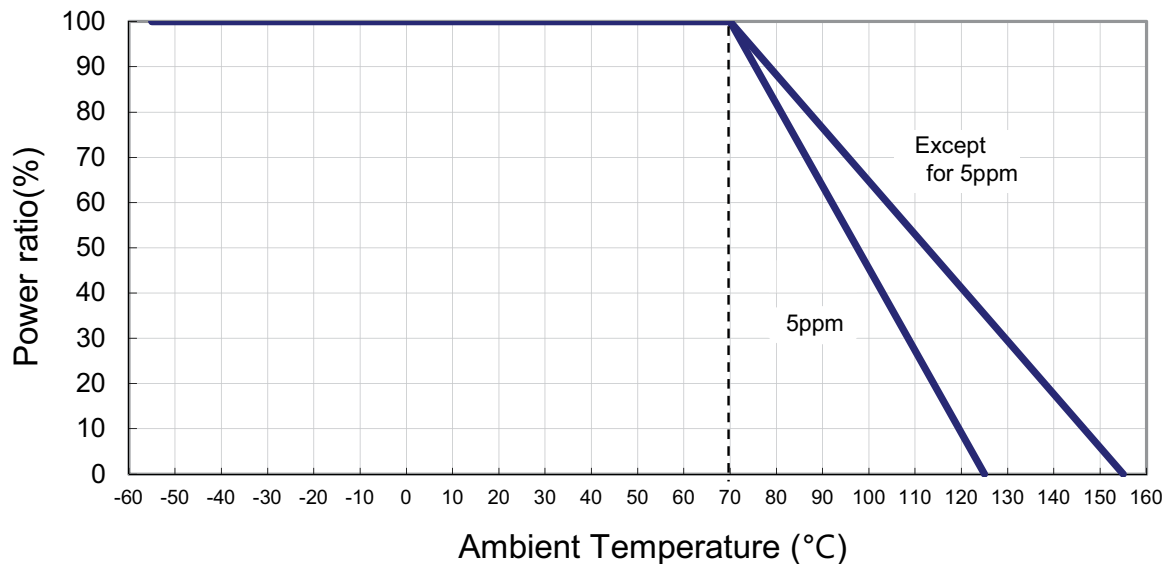

# METAL FILM PRECISION MELF RESISTOR

AEC-Q200 Qualified Type SMA-Q Series

## STANDARD ELECTRICAL SPECIFICATIONS

Size	Power Rating at 70°C	Max. Operating Voltage	Max. Overload Voltage	Resistance Range					TCR (PPM/°C)
				±0.1%	±0.25%	±0.5%	±1%	±5%	
0102	0.2W	200V	400V	100Ω-56KΩ			-	±15	
				100Ω-82KΩ	49.9Ω - 200KΩ	49.9Ω - 390KΩ	-	±25	
				-	1Ω-1MΩ			±50	
				-	1Ω-1MΩ			±100	
	Jumper: 2A	0Ω(<15mΩ)			-				
0204	0.25W	200V	400V	10Ω-332KΩ	-			±5	
				10Ω-332KΩ			-	±10	
				10Ω-332KΩ			-	±15	
				10Ω-1MΩ	10Ω-3.4MΩ	1Ω-3.4MΩ		±25	
				10Ω-1MΩ	1Ω-3.4MΩ	0.2Ω-10MΩ		±50	
				-	0.1Ω-10MΩ			±100	
	Jumper: 3A	0Ω(<15mΩ)			-				
0207	0.5W	300V	600V	10Ω-332KΩ	-			±5	
				10Ω-332KΩ			-	±10	
				10Ω-332KΩ			-	±15	
				10Ω-1MΩ	10Ω-3.4MΩ	1Ω-3.4MΩ		±25	
				10Ω-1MΩ	1Ω-3.4MΩ	0.2Ω-10MΩ		±50	
				-	0.1Ω-10MΩ			±100	
	Jumper: 5A	0Ω(<15mΩ)			-				

### NOTE:

- Operating voltage= $\sqrt{P \cdot R}$  or max. operating voltage listed above, whichever is lower
- Overload voltage= $2.5 \cdot \sqrt{P \cdot R}$  or max. overload voltage listed above, whichever is lower.
- RCWV (Rated Continuous Working Voltage) =  $\sqrt{P \cdot R}$  OR max. operating voltage whichever is lower.
- Operating temperature range - -55°C-155°C

# METAL FILM PRECISION MELF RESISTOR

AEC-Q200 Qualified Type SMA-Q Series

## HIGH POWER RATING ELECTRICAL SPECIFICATIONS

Size	Power Rating at 70°C	Max. Operating Voltage	Max. Overload Voltage	Resistance Range					TCR (PPM/°C)	
				±0.1%	±0.25%	±0.5%	±1%	±5%		
0102	0.3W	200V	400V	100Ω-56KΩ					-	±15
				100Ω-82KΩ	49.9Ω - 200KΩ	49.9Ω - 390KΩ			-	±25
				-	1Ω-1MΩ					±50
				-			1Ω-1MΩ			±100
	Jumper: 2A	0Ω(<15mΩ)						-		
0204	0.4W	200V	400V	10Ω-332KΩ					-	±5
				10Ω-332KΩ					-	±10
				10Ω-332KΩ					-	±15
				10Ω-1MΩ	10Ω-3.4MΩ	1Ω-3.4MΩ			±25	
				10Ω-1MΩ	1Ω-3.4MΩ	0.2Ω-10MΩ			±50	
				-			0.1Ω-10MΩ			±100
	Jumper: 3A	0Ω(<15mΩ)						-		
0207	1W	300V	600V	10Ω-332KΩ					-	±5
				10Ω-332KΩ					-	±10
				10Ω-332KΩ					-	±15
				10Ω-1MΩ	10Ω-3.4MΩ	1Ω-3.4MΩ			±25	
				10Ω-1MΩ	1Ω-3.4MΩ	0.2Ω-10MΩ			±50	
				-			0.1Ω-10MΩ			±100
	Jumper: 5A	0Ω(<15mΩ)						-		

**NOTE:**

1. Operating voltage= $\sqrt{P \cdot R}$  or max. operating voltage listed above, whichever is lower
2. Overload voltage= $2.5 \cdot \sqrt{P \cdot R}$  or max. overload voltage listed above, whichever is lower.
3. RCWV (Rated Continuous Working Voltage) =  $\sqrt{P \cdot R}$  OR max. operating voltage whichever is lower.
4. Operating temperature range - -55°C-155°C

# METAL FILM PRECISION MELF RESISTOR

AEC-Q200 Qualified Type SMA-Q Series

## PULSE WITHSTANDING CAPACITY

The single impulse graph is the result of 50 impulses of rectangular shape applied. The limit of acceptance was a shift in resistance of less than 1% from the initial value. The power applied was subject to the restrictions of the maximum permissible impulse voltage graph shown.

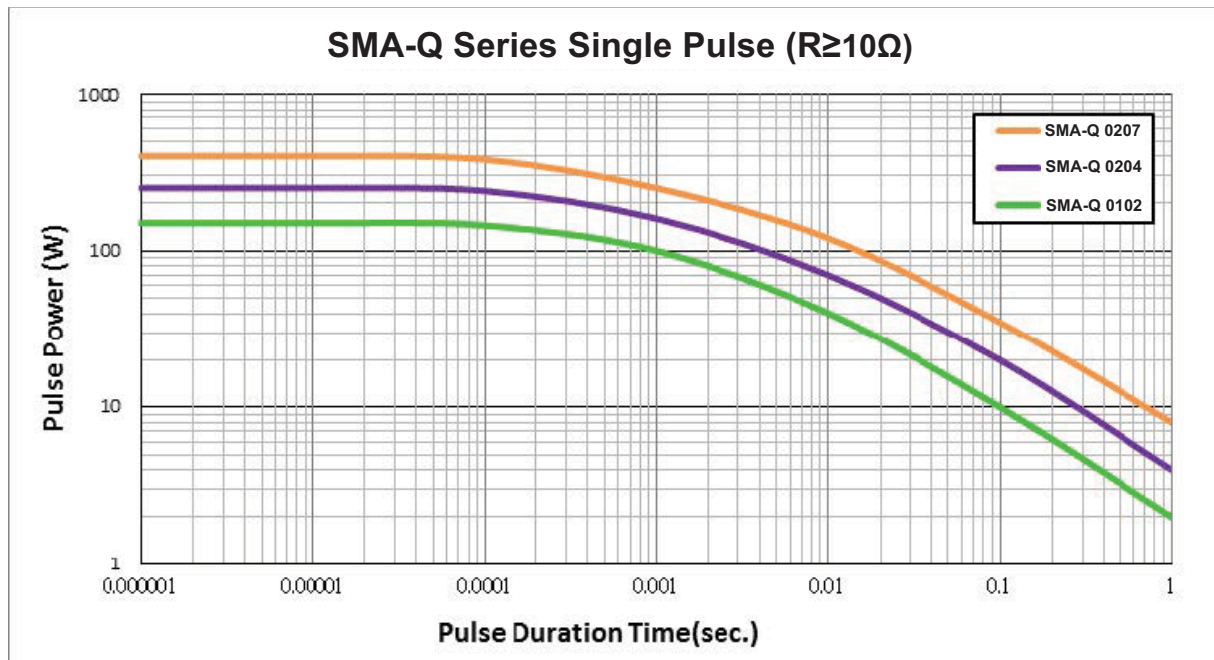
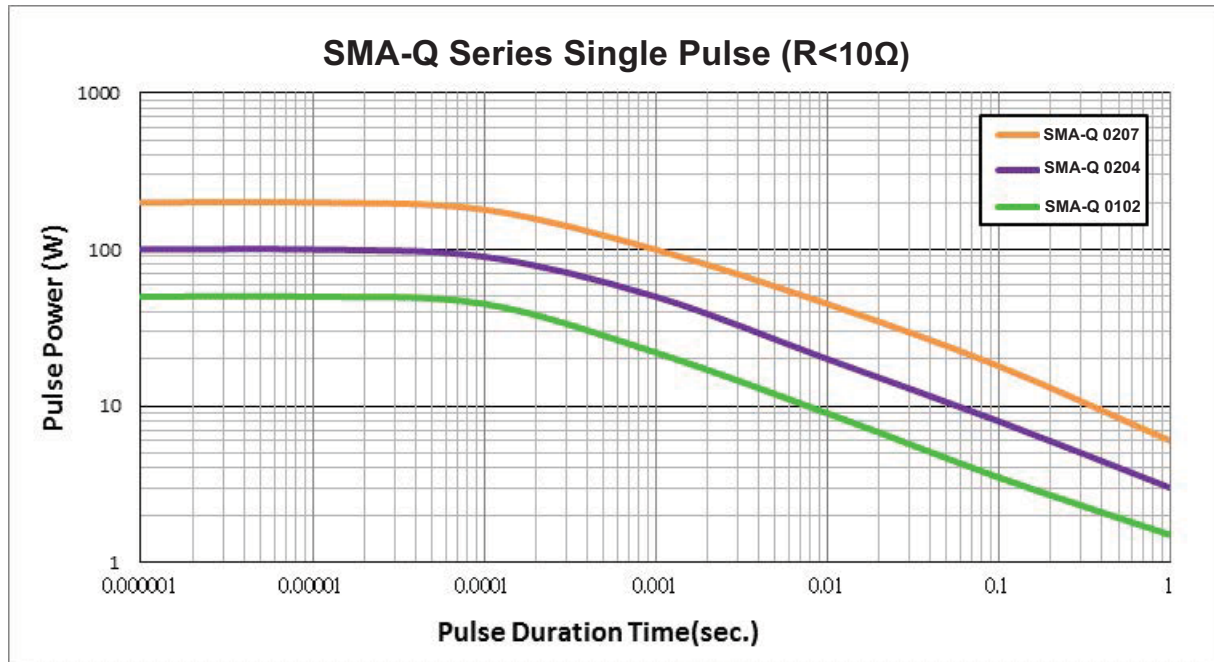

# METAL FILM PRECISION MELF RESISTOR

AEC-Q200 Qualified Type SMA-Q Series

## CONTINUOUS PULSE

The continuous load graph was obtained by applying repetitive rectangular pulses where the pulse period was adjusted so that the average power dissipated in the resistor was equal to its rated power at 70°C. Again the limit of acceptance was a shift in resistance of less than 1% from the initial value.

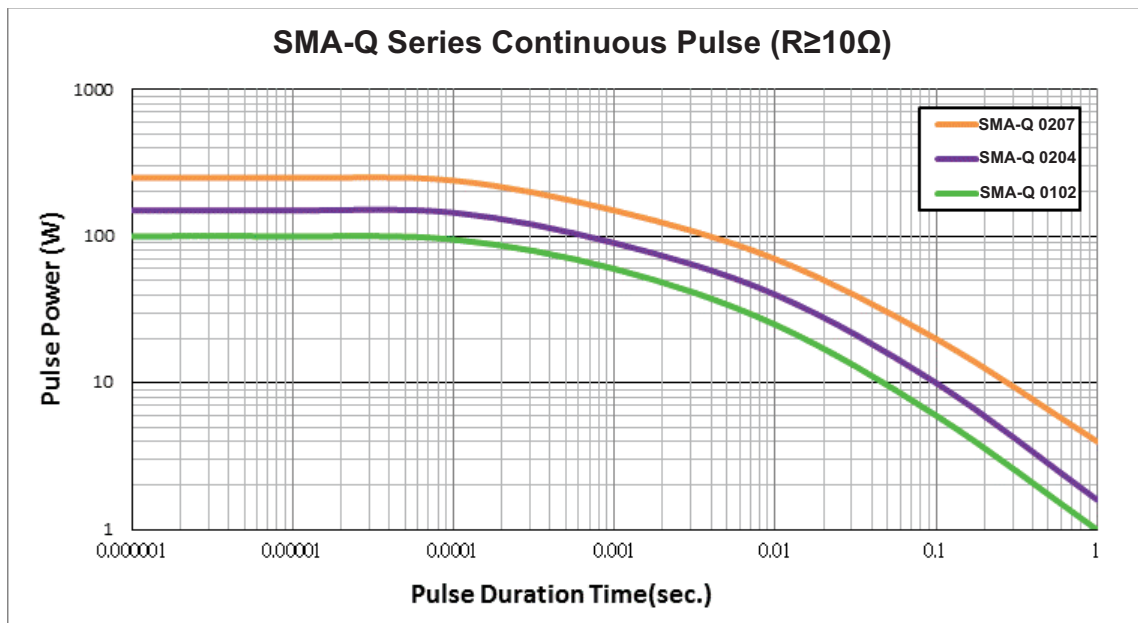
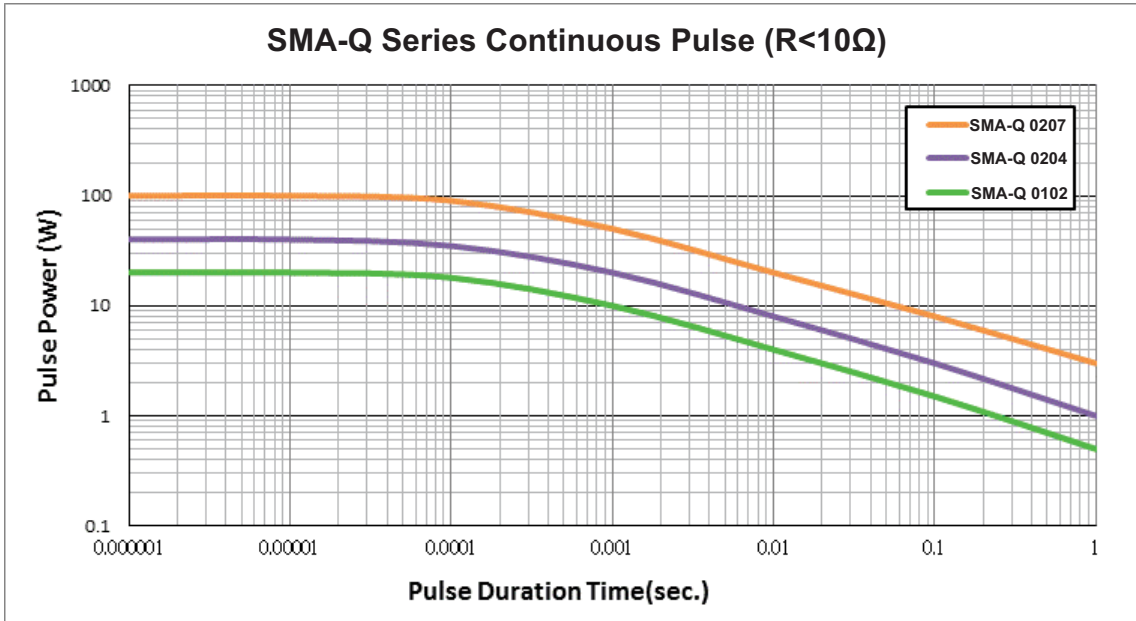

# METAL FILM PRECISION MELF RESISTOR

AEC-Q200 Qualified Type SMA-Q Series

## LIGHTNING SURGE

Resistors are tested in accordance with IEC 60115-1 using both 1.2/50 $\mu$ s and 10/700 $\mu$ s pulse shapes. The limit of acceptance is a shift in resistance of less than 0.5% from the initial value.

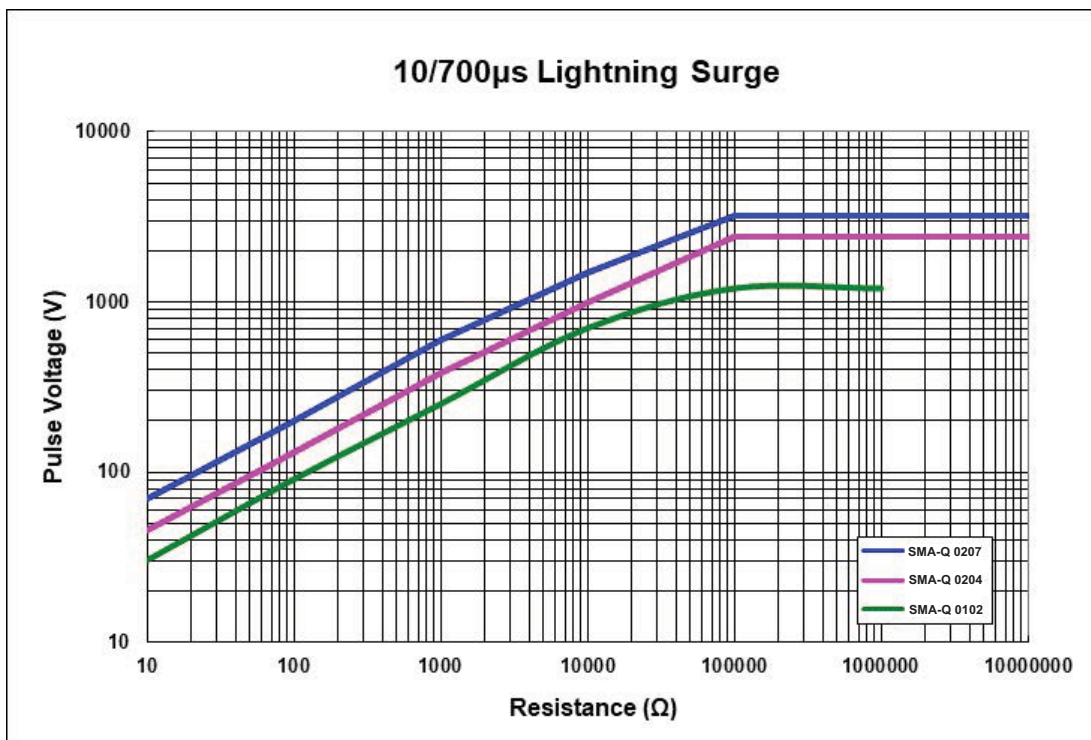
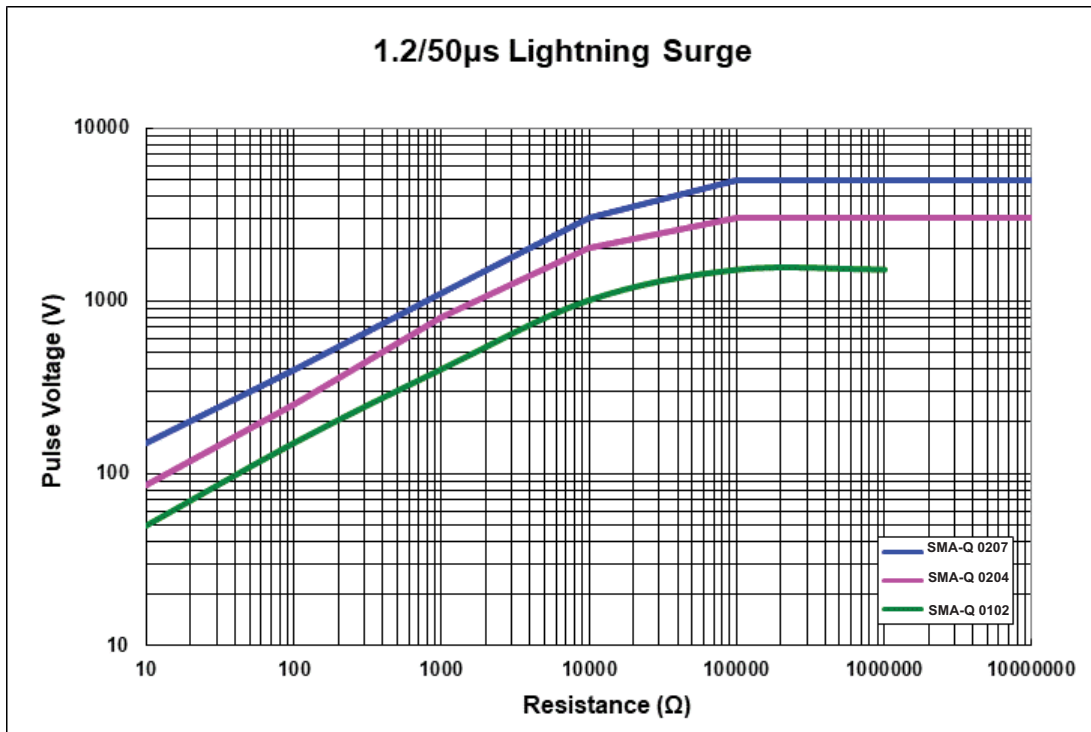



# METAL FILM PRECISION MELF RESISTOR

AEC-Q200 Qualified Type SMA-Q Series

## FREQUENCY BEHAVIOUR

Resistors are designed to function according to ohmic laws. This is basically true of resistors for frequencies up to 100kHz. At higher frequencies, there is an additional contribution to the impedance by an ideal resistor switched in series with a coil and both switched parallel to a capacitor. The values of the capacitance and inductance are mainly determined by the dimensions of the terminations and the conductive path length.

The environment surrounding components has a large influence on the behaviour of the component on the printed-circuit board.

### Frequency vs. Impedance SMA-Q 0204

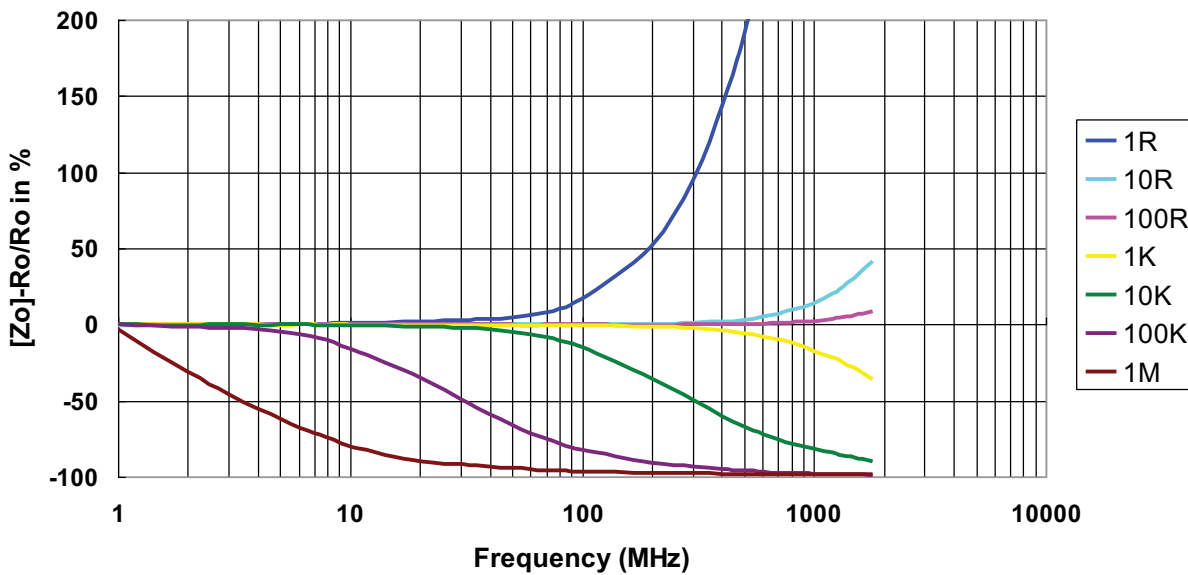

### Frequency vs. Phase Angle SMA-Q 0204

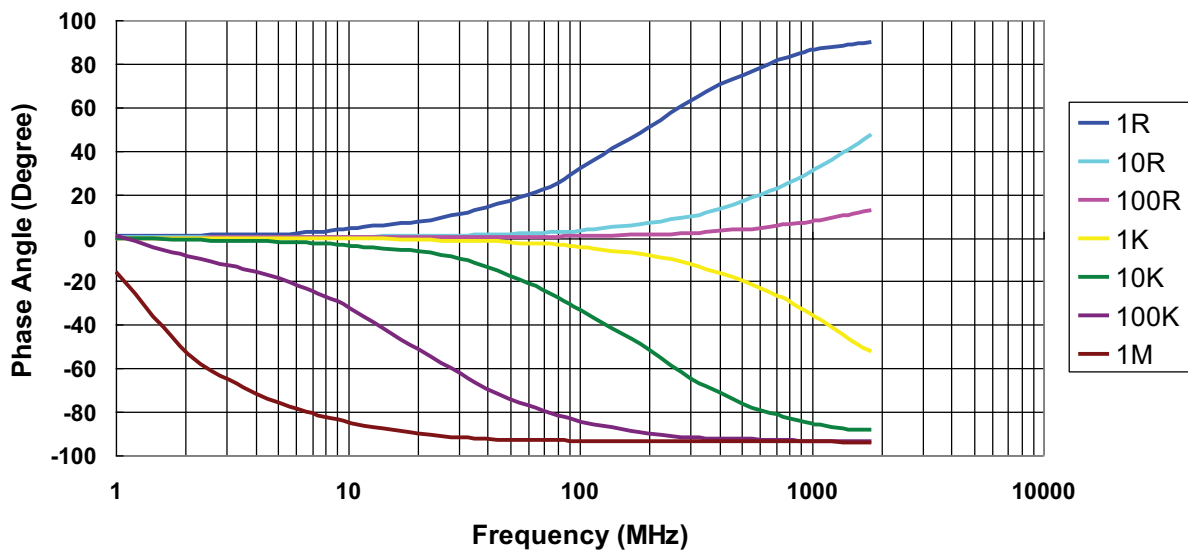

# METAL FILM PRECISION MELF RESISTOR

AEC-Q200 Qualified Type SMA-Q Series

## Frequency vs. Impedance SMA-Q 0207

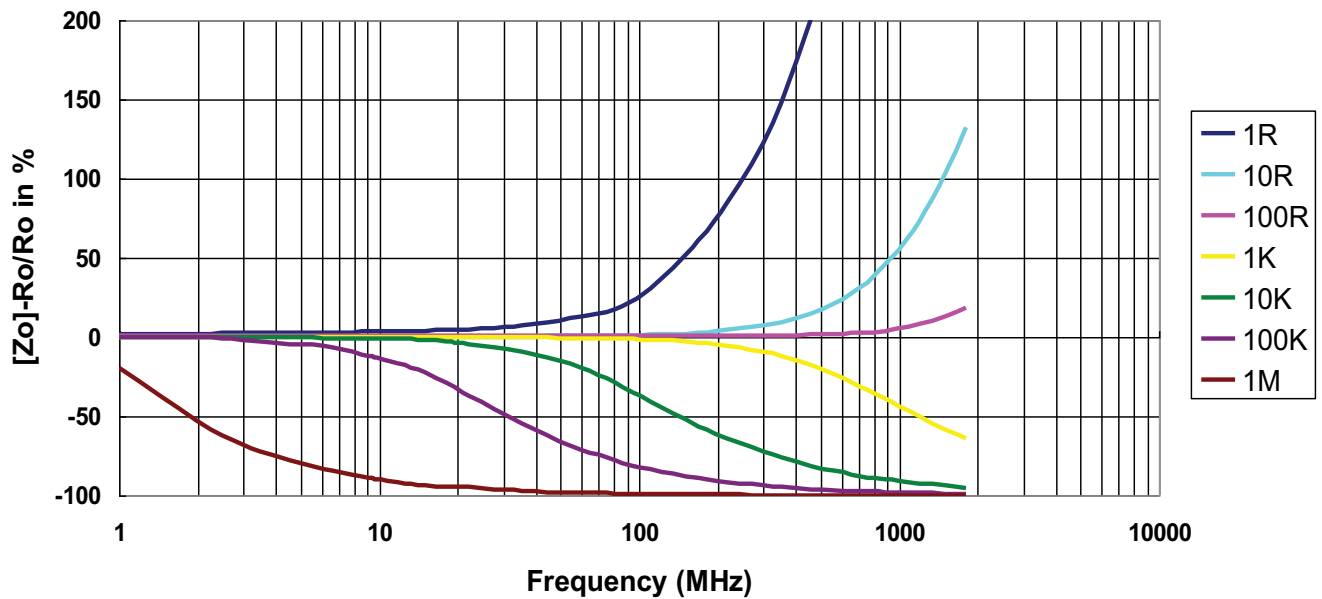

## Frequency vs. Phase Angle SMA-Q 0207

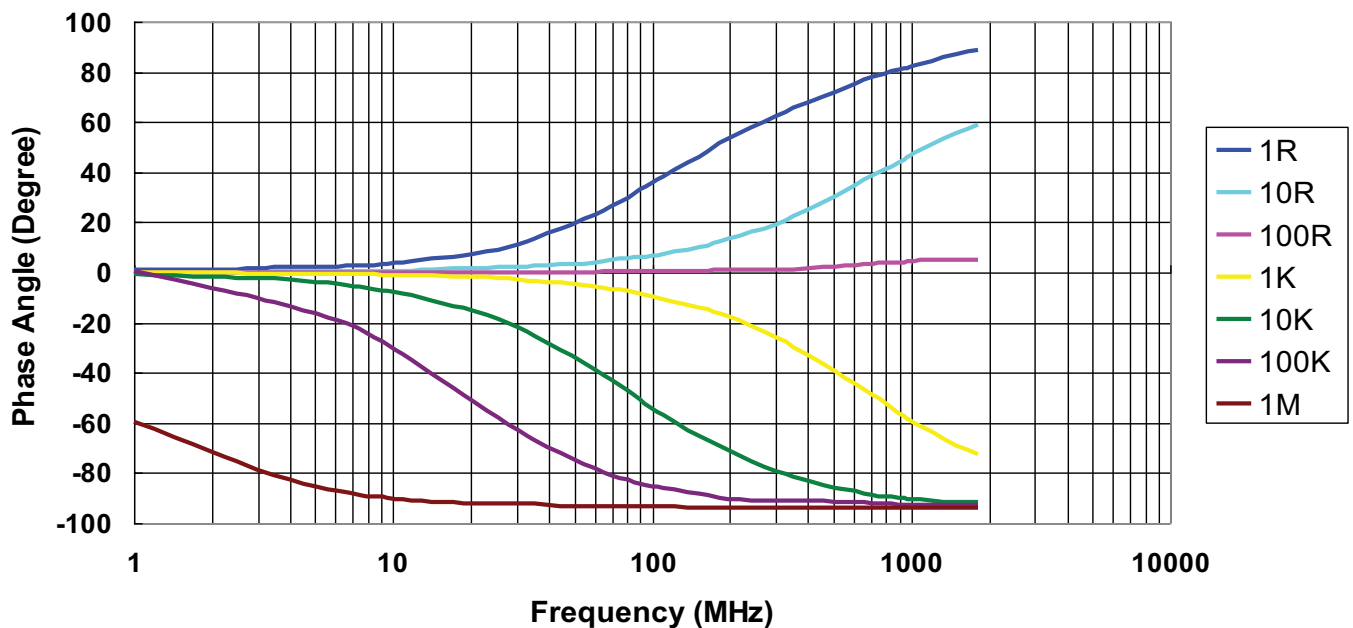

# METAL FILM PRECISION MELF RESISTOR

AEC-Q200 Qualified Type SMA-Q Series

## ENVIRONMENTAL CHARACTERISTICS

Item	Requirement	Test Method
Temperature Coefficient of Resistance (T.C.R.)	As per specification	<b>JIS-C-5201-1 4.8</b> <b>IEC-60115-1 4.8</b> At 25°C/-55°C and 25°C/+125°C is the reference temperature 5ppm: At 25°C/-10°C and 25°C/+85°C, 25°C is the reference temperature
Short-term overload	10Ω-332KΩ: ±(0.1%+0.01Ω) <10Ω & >332KΩ: ±(0.15%+0.01Ω) 0102: ±(0.15%+0.01Ω) 5ppm: ±(0.05%+0.01Ω)	<b>JIS-C-5201-1 4.13</b> <b>IEC-60115-1 4.13</b> RCWV*2.5 or max. overload voltage whichever is lower for 5 seconds
Insulation resistance	≥10G	<b>JIS-C-5201-1 4.6</b> <b>IEC-60115-1 4.6</b> Max. overload voltage for 1 minute
Endurance	10Ω-332KΩ: ±(0.25%+0.01Ω) <10Ω & >332KΩ: ±(0.5%+0.01Ω) 0102: ±(0.5%+0.01Ω)	<b>MIL-STD-202 Method 108</b> Condition D steady state TA=125°C at derated power. Measurement at 24±4 hours after test conclusion. 5ppm: 70±2°C, RCWV for 1000 hrs with 1.5 hrs "ON" and 0.5 hr "OFF"
Biased humidity	10Ω: ±(0.5%+0.01Ω) 10Ω-332KΩ: ±(0.25%+0.01Ω) >332KΩ-3.4MΩ: ±(1%+0.01Ω) 3.4MΩ: ±(2%+0.01Ω) 0102: ±(1%+0.01Ω)	<b>MIL-STD-202 Method 103</b> 1344 hrs 85°C/85% RH 10% of operating power. (≤100 V)
High temperature exposure	10Ω-332KΩ: ±(0.25%+0.01Ω) <10Ω & >332KΩ: ±(0.5%+0.01Ω) 0102: ±(1%+0.01Ω)	<b>MIL-STD-202 Method 108</b> at +125°C/+155°C for 1000 hrs
Board flex	10Ω-332KΩ: ±(0.1%+0.01Ω) <10Ω & >332KΩ: ±(0.2%+0.01Ω) 0102: ±(0.5%+0.01Ω)	<b>AEC-Q200-005</b> Bending once for 60 seconds with 2mm
Solderability	95% min. coverage	<b>JIS-C-5201-1 4.17</b> <b>IEC-60115-1 4.17</b> <b>J-STD-002</b> 245±5°C for 3 seconds
Resistance to soldering heat	10Ω-332KΩ: ±(0.1%+0.01Ω) <10Ω & >332KΩ: ±(0.25%+0.01Ω) 0102: ±(0.25%+0.01Ω) 5ppm: ±(0.05%+0.01Ω)	<b>MIL-STD-202 Method 210</b> 260±5°C for 10 seconds
Voltage proof	No breakdown or flashover	<b>JIS-C-5201-1 4.7</b> <b>IEC-60115-1 4.7</b> 1.42 times max. operating voltage for 1 minute
Leaching	Individual leaching area ≤5% Total leaching area ≤10%	<b>JIS-C-5201-1 4.18</b> <b>IEC-60068-2-58 8.2.1</b> 260±5°C for 30 seconds
Temperature cycling	10Ω-332KΩ: ±(0.15%+0.01Ω) <10Ω & >332KΩ: ±(0.5%+0.01Ω) 0102: ±(1%+0.01Ω)	<b>JESD22 Method JA-104</b> -55°C to +125°C, 1000 cycles

# METAL FILM PRECISION MELF RESISTOR

AEC-Q200 Qualified Type SMA-Q Series

## ENVIRONMENTAL CHARACTERISTICS

Item	Requirement	Test Method
Mechanical shock	$\pm(0.25\%+0.01\Omega)$	<b>MIL-STD-202 Method 213</b> Wave Form: Tolerance for half sine shock pulse. Peak value is 100g's. Normal duration (D) is 6ms.
Vibration	$\pm(0.5\%+0.01\Omega)$	<b>MIL-STD-202 Method 204</b> 5 g's for 20 min., 12 cycles each of 3 orientations, 10-2000 Hz
ESD	$\pm(0.5\%+0.01\Omega)$	<b>AEC-Q200-002</b> Human body, 0102/0204:2KV; 0207:4KV
Moisture sensitivity level	-	Level 1
Resistance to solvents	No visible damage on appearance and marking	<b>MIL-STD-202 Method 215</b> Add aqueous wash chemical - OKEM Clean or equivalent. Do not use banned solvents.
Terminal strength	Not broken	<b>AEC-Q200-006</b> Force of 1.8kg for 60 seconds.
Flammability	No ignition of the tissue paper or scorching of the pinewood board	<b>UL-94</b> V-0 or V-1 are acceptable. Electrical test not required.

### Notes:

1. RCWV (Rated Continuous Working Voltage) =  $\sqrt{P \cdot R}$  or max. operating voltage whichever is lower.
2. Storage temperature: 15°C-28°C; Humidity < 80%RH
3. Shelf life: 2 years from production date.

## PACKAGING

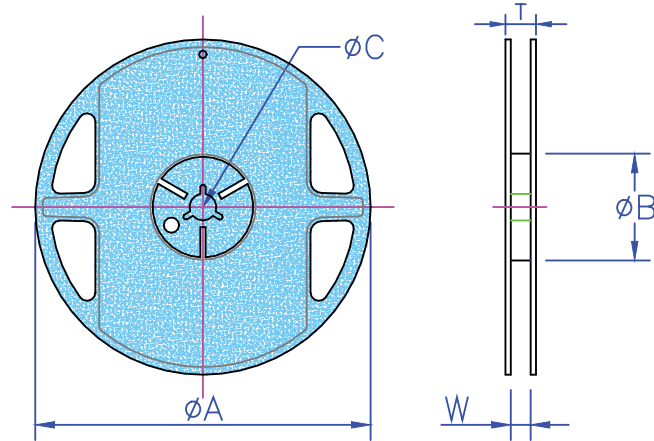

Type	Reel Diameter	ΦA (mm)	ΦB (mm)	ΦC (mm)	W (mm)	T (mm)	Emboss Plastic Tape (EA)
SMA-Q 0102	7 inch	178.5±1.5	60.0+1.0	13.0±0.2	9.0±0.5	12.5±0.5	3,000
SMA-Q 0204	7 inch	178.5±1.5	60.0+1.0	13.0±0.2	9.0±0.5	12.5±0.5	3,000
SMA-Q 0207	7 inch	178.5±1.5	60.0+1.0	13.0±0.5	13.0±0.5	15.5±0.5	2,000

# METAL FILM PRECISION MELF RESISTOR

AEC-Q200 Qualified Type SMA-Q Series

## EMBOSSED PLASTIC TAPE SPECIFICATION

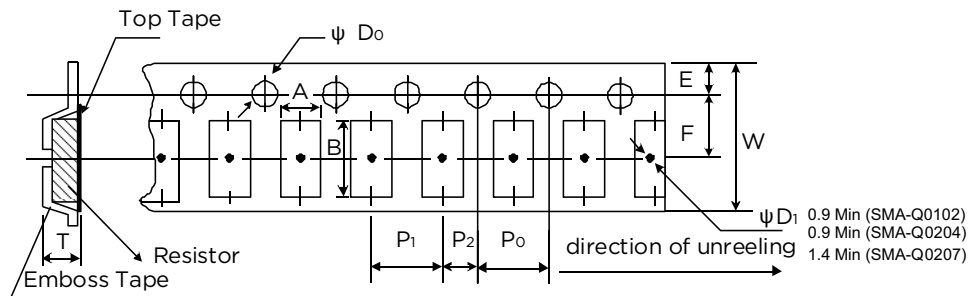

Type	A (mm)	B (mm)	W (mm) ±0.10	E (mm) ±0.10	F (mm) ±0.05	P <sub>0</sub> (mm) ±0.10	P <sub>1</sub> (mm) ±0.10	P <sub>2</sub> (mm) ±0.10	ΦD <sub>o</sub> (mm) ±0.10	T (mm) ±0.10
SMA-Q 0102	1.30±0.20	2.40±0.20	8.0	1.75	3.50	4.00	4.00	2.00	1.50	1.50
SMA-Q 0204	1.55±0.20	3.65±0.20	8.0	1.75	3.50	4.00	4.00	2.00	1.50	1.80
SMA-Q 0207	2.40±0.10	6.15±0.10	12.0	1.75	5.50	4.00	4.00	2.00	1.50	2.70

## MARKING

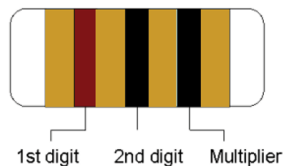

±5%	E-24	1.0	1.1	1.2	1.3	1.5	1.6	1.8	2.0	2.2	2.4	2.7	3.0	3.3	3.6	3.9	4.3	4.7	5.1	5.6	6.2	6.8	7.5	8.2	9.1
-----	------	-----	-----	-----	-----	-----	-----	-----	-----	-----	-----	-----	-----	-----	-----	-----	-----	-----	-----	-----	-----	-----	-----	-----	-----

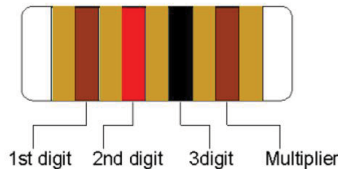

±1%	E-96	1.00	1.02	1.05	1.07	1.10	1.13	1.15	1.18	1.21	1.24	1.27	1.30	1.33	1.37	1.40	1.43	1.47	1.50	1.54	1.58	1.62	1.65	1.69	1.74
		1.78	1.82	1.87	1.91	1.96	2.00	2.05	2.10	2.15	2.21	2.26	2.32	2.37	2.43	2.49	2.55	2.61	2.67	2.74	2.80	2.87	2.94	3.01	3.09
		3.16	3.24	3.32	3.40	3.48	3.57	3.65	3.74	3.83	3.92	4.02	4.12	4.22	4.32	4.42	4.53	4.64	4.75	4.87	4.99	5.11	5.23	5.36	5.49
±0.5%	E-192	5.62	5.76	5.90	6.04	6.19	6.34	6.49	6.65	6.81	6.98	7.15	7.32	7.50	7.68	7.87	8.06	8.25	8.45	8.66	8.87	9.09	9.31	9.53	9.76
		10.0	10.1	10.2	10.4	10.5	10.6	10.7	10.9	11.0	11.1	11.3	11.4	11.5	11.7	11.8	12.0	12.1	12.3	12.4	12.6	12.7	12.9	13.0	13.2
		13.3	13.5	13.7	13.8	14.0	14.2	14.3	14.5	14.7	14.9	15.0	15.2	15.4	15.6	15.8	16.0	16.2	16.4	16.5	16.7	16.9	17.2	17.4	17.6
±0.25%	E-192	17.8	18.0	18.2	18.4	18.7	18.9	19.1	19.3	19.6	19.8	20.0	20.3	20.5	20.8	21.0	21.3	21.5	21.8	22.1	22.3	22.6	22.9	23.2	23.4
		23.7	24.0	24.3	24.6	24.9	25.2	25.5	25.8	26.1	26.4	26.7	27.1	27.4	27.7	28.0	28.4	28.7	29.1	29.4	29.8	30.1	30.5	30.9	31.2
±0.1%	E-192	31.6	32.0	32.4	32.8	33.2	33.6	34.0	34.4	34.8	35.2	35.7	36.1	36.5	37.0	37.4	37.9	38.3	38.8	39.2	39.7	40.2	40.7	41.2	41.7
		42.2	42.7	43.2	43.7	44.2	44.8	45.3	45.9	46.4	47.0	47.5	48.1	48.7	49.3	49.9	50.5	51.1	51.7	52.3	53.0	53.6	54.2	54.9	55.6
		56.2	56.9	57.6	58.3	59.0	59.7	60.4	61.2	61.9	62.6	63.4	64.2	64.9	65.7	66.5	67.3	68.1	69.0	69.8	70.6	71.5	72.3	73.2	74.1
		75.0	75.9	76.8	77.7	78.7	79.6	80.6	81.6	82.5	83.5	84.5	85.6	86.6	87.6	88.7	89.8	90.9	92.0	93.1	94.2	95.3	96.5	97.6	98.8

Color	Digit	Multiplier
Silver	-	10 <sup>-2</sup>
Gold	-	10 <sup>-1</sup>
Black	0	10 <sup>0</sup>
Brown	1	10 <sup>1</sup>
Red	2	10 <sup>2</sup>
Orange	3	10 <sup>3</sup>
Yellow	4	10 <sup>4</sup>
Green	5	10 <sup>5</sup>
Blue	6	10 <sup>6</sup>
Violet	7	10 <sup>7</sup>
Grey	8	10 <sup>8</sup>
White	9	10 <sup>9</sup>

### Note:

Resistance values with more than two significant figures (<1R) or more than three significant figures (>1R) will not provide colour code.

## ORDERING INFORMATION

Typical product code  
SMA-Q 0204 B T N X 100R

### Common Part

<b>SMA-Q</b>	MELF Resistor AEC-Q200 compliant
--------------	-------------------------------------

### Size

<b>0102</b>
<b>0204</b>
<b>0207</b>

### Tolerance

<b>B</b>	0.1%
<b>C</b>	0.25%
<b>D</b>	0.5%
<b>F</b>	1%
<b>J</b>	5%

### Packaging

<b>T</b>	Tape and Reel
----------	---------------

### Resistance Codes

<b>10R</b>	10Ω
<b>100R</b>	100Ω
<b>1K0</b>	1,000Ω
<b>10K</b>	10,000Ω
<b>100K</b>	100,000Ω
<b>1M0</b>	1,000,000Ω

### Power Rating

<b>T</b>	1W
<b>U</b>	0.5W
<b>X</b>	0.4W
<b>L</b>	0.3W
<b>V</b>	0.25W
<b>P</b>	0.2W

### TCR

<b>A</b>	±5PPM/°C
<b>B</b>	±10PPM/°C
<b>N</b>	±15PPM/°C
<b>C</b>	±25PPM/°C
<b>D</b>	±50PPM/°C
<b>E</b>	±100PPM/°C

[te.com](http://te.com)

©2023 TE Connectivity. All Rights Reserved.

TE Connectivity, TE connectivity (logo) and Every Connection Counts are trademarks owned or licensed by the TE Connectivity family of companies. All other logos, products and/or company names referred to herein might be trademarks of their respective owners.

While TE has made every reasonable effort to ensure the accuracy of the information in this document, TE does not guarantee that it is error-free, nor does TE make any other representation, warranty or guarantee that the information is accurate, correct, reliable or current. TE reserves the right to make any changes to the information contained herein without prior notice. TE Connectivity assumes only those obligations set forth in the terms and conditions for this product and shall in no event be liable for any incidental, indirect, or consequential damages arising out of the sale, resale, use, or misapplication of the product. TE expressly disclaims any implied warranties with respect to the information contained herein, including, but not limited to, implied warranties of merchantability or fitness for a particular purpose. Dimensions, specifications and/or information contained herein are for reference purposes only and are subject to change without notice. Consult TE for the latest dimensions, specifications and/or information. Users of TE Connectivity products must make their own assessment as to whether the respective product is suitable for the respective desired application.

6-1773446-3 REV:A 11/23 ED