

**Type SMA series**

**PRODUCT PLANNED FOR EOL**  
**LTB 18/08/2023**

**Key Features**

Excellent overall stability

Sn termination on Ni barrier layer

Tight tolerance down to  $\pm 0.1\%$

Extremely low TCR down to  $\pm 10$  PPM/ $^{\circ}$ C

SMD enabled structure

Lead-free and RoHS compliant

**Applications**

Industrial

Telecommunication

Medical Equipment

Measurement/Testing Equipment



The SMA series is a metal film precision MELF resistor with an SMD enabled structure, tight tolerance and low TCR.

It comes in two sizes and four power ratings to 1W, is lead free and RoHS compliant.

**Standard Electrical Specifications**

Size	Power Rating at 70 $^{\circ}$ C	Max. Operating Voltage	Max. Overload Voltage	Resistance Range					TCR (PPM/ $^{\circ}$ C)
				$\pm 0.1\%$	$\pm 0.25\%$	$\pm 0.5\%$	$\pm 1\%$	$\pm 5\%$	
0204	0.25W	200V	400V	10 $\Omega$ -20K $\Omega$					$\pm 10$
				10 $\Omega$ -300K $\Omega$					$\pm 15$
				10 $\Omega$ -1M $\Omega$		4.02 $\Omega$ -4.7M $\Omega$			$\pm 25$
				10 $\Omega$ -1M $\Omega$	1 $\Omega$ -1M $\Omega$	0.2 $\Omega$ -10M $\Omega$		$\pm 50$	
				-		0.1 $\Omega$ -10M $\Omega$			$\pm 100$
	0 $\Omega$ (<15m $\Omega$ )					-			
0207	0.5W	300V	600V	10 $\Omega$ -20K $\Omega$					$\pm 10$
				10 $\Omega$ -300K $\Omega$					$\pm 15$
				10 $\Omega$ -1M $\Omega$		4.02 $\Omega$ -4.7M $\Omega$			$\pm 25$
				10 $\Omega$ -1M $\Omega$	1 $\Omega$ -1M $\Omega$	0.2 $\Omega$ -10M $\Omega$		$\pm 50$	
				-		0.1 $\Omega$ -10M $\Omega$			$\pm 100$
	0 $\Omega$ (<15m $\Omega$ )					-			
	Jumper: 2A								
	Jumper: 4A								

**High Power Rating Electrical Specifications**

Size	Power Rating at 70°C	Max. Operating Voltage	Max. Overload Voltage	Resistance Range					TCR (PPM/°C)
				±0.1%	±0.25%	±0.5%	±1%	±5%	
0204	0.4W	200V	400V	10Ω-100KΩ					±15
				10Ω-1MΩ			4.02Ω-1MΩ		±25
				10Ω-1MΩ	1Ω - 1MΩ		0.2Ω-1MΩ		±50
				-					0.1Ω-1MΩ
0207	1W	350V	700V	10Ω-100KΩ					±15
				10Ω-1MΩ			4.02Ω-1MΩ		±25
				10Ω-1MΩ	1Ω - 1MΩ		0.2Ω-10MΩ		±50
				-					0.1Ω-10MΩ

Operating Voltage= $v(P \cdot R)$  or Max. Operating Voltage listed above, whichever is lower  
 Overload Voltage= $2.5 \cdot v(P \cdot R)$  or Max. Overload Voltage listed above, whichever is lower.  
 RCWV(Rated Continuous Working Voltage)= $v(P \cdot R)$  or Max. Operating Voltage whichever is lower.  
 Operating temperature range - -55°C~155°C

**Derating Curve**

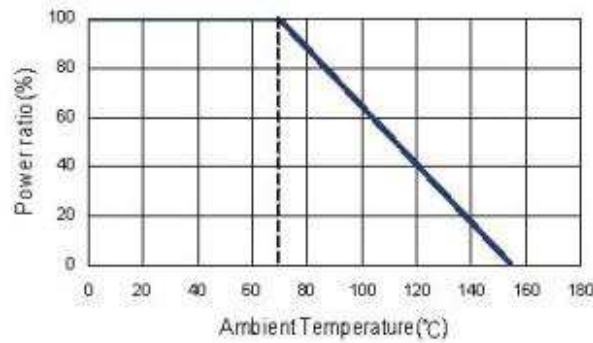

**Construction and Dimensions**

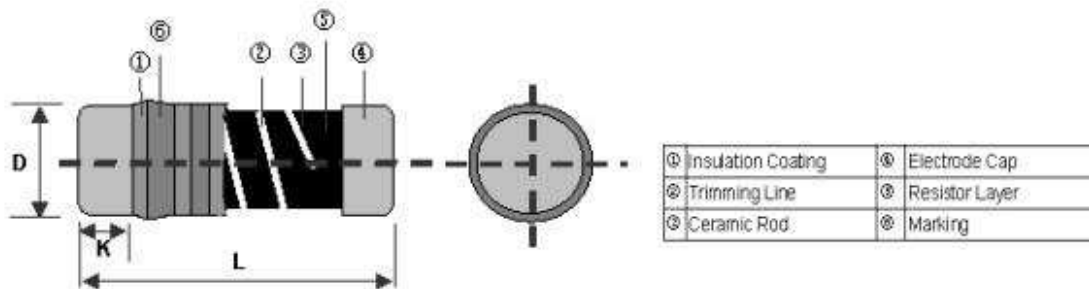

Type	L (mm)	ΦD (mm)	K (mm)	Weight 1,000EA (g)
SMA0204	3.50±0.2	1.40±0.15	0.8±0.1	18.7
SMA0207	5.90±0.2	2.20±0.20	1.3±0.1	80.9

**Recommended Land Pattern**

Type	A (mm)	B (mm)	C (mm)
SMA0204	1.6	1.2	1.6
SMA0207	3.0	1.7	2.4

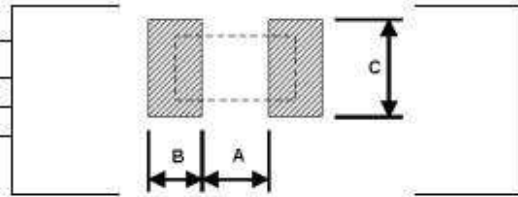

**Soldering Condition**

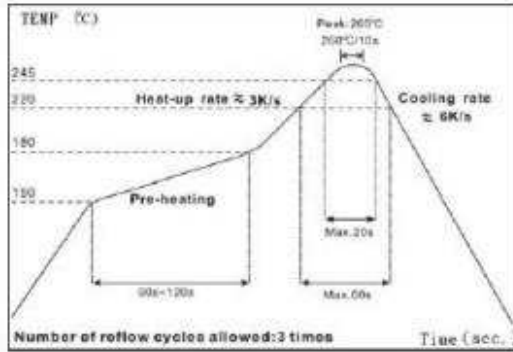

IR Reflow Soldering

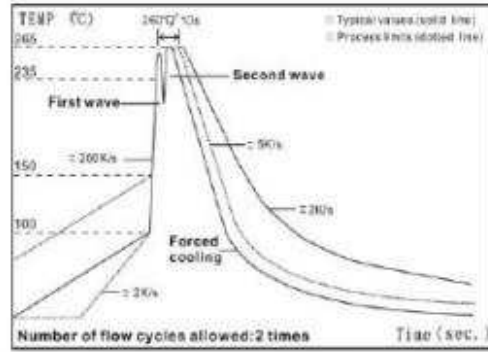

Wave Soldering (Flow Soldering)

- (1) Time of IR reflow soldering at maximum temperature point 260°C : 10s
- (2) Time of wave soldering at maximum temperature point 260°C : 10s
- (3) Time of soldering iron at maximum temperature point 410°C : 5s

**Pulse withstanding capacity**

The single impulse graph is the result of 50 impulses of rectangular shape applied at one-minute intervals. The limit of acceptance was a shift in resistance of less than 1% from the initial value. The power applied was subject to the restrictions of the maximum permissible impulse voltage graph shown

**SMA Series Single Pulse(100 Ohm)**

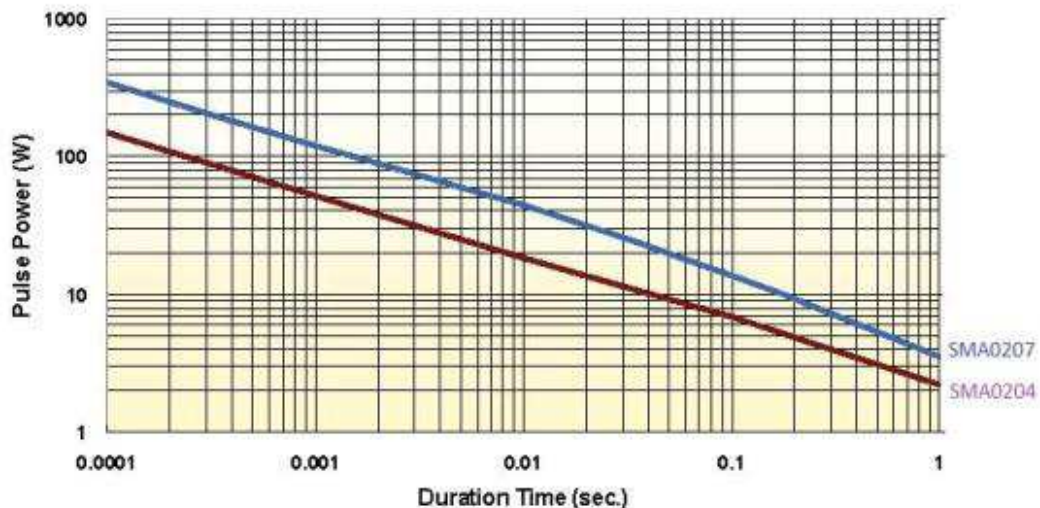



**Continuous Pulse**

The continuous load graph was obtained by applying repetitive rectangular pulses where the pulse period was adjusted so that the average power dissipated in the resistor was equal to its rated power at 70°C. Again the limit of acceptance was a shift in resistance of less than 1% from the initial value

**SMA series Continuous Pulse (100 Ohm)**

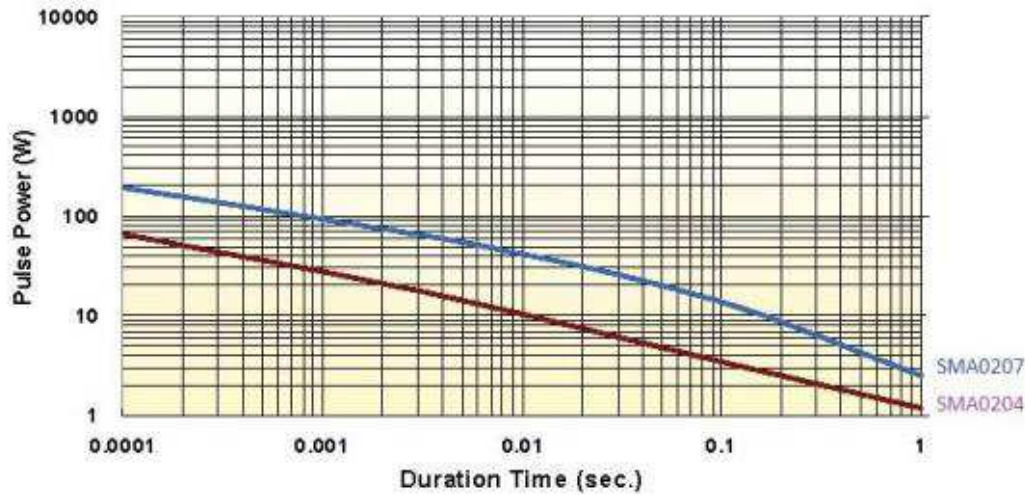

**SMA series Pulse Voltage (100 Ohm)**

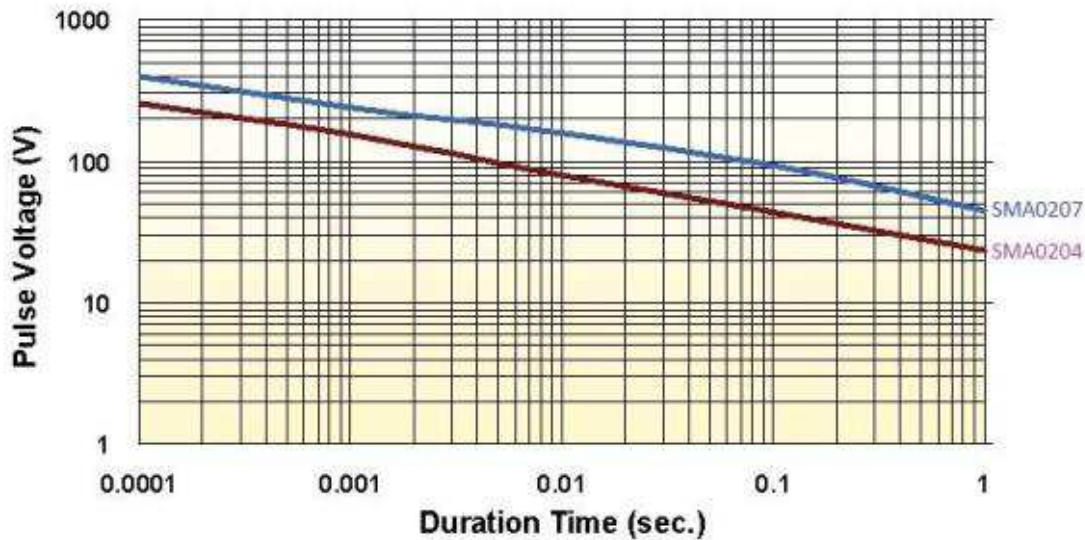

**Frequency behaviour**

Resistors are designed to function according to ohmic laws. This is basically true of resistors for frequencies up to 100kHz. At higher frequencies, there is an additional contribution to the impedance by an ideal resistor switched in series with a coil and both switched parallel to a capacitor. The values of the capacitance and inductance are mainly determined by the dimensions of the terminations and the conductive path length.

The environment surrounding components has a large influence on the behavior of the component on the printed-circuit board.

**Frequency Vs. Impedance**

**SMA0204**

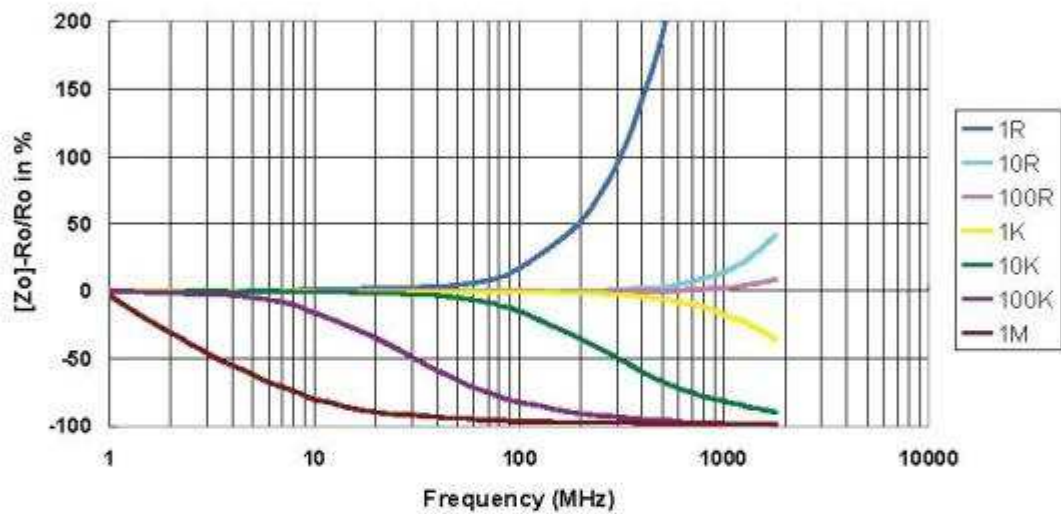

**Frequency Vs Phase Angle**

**SMA0204**

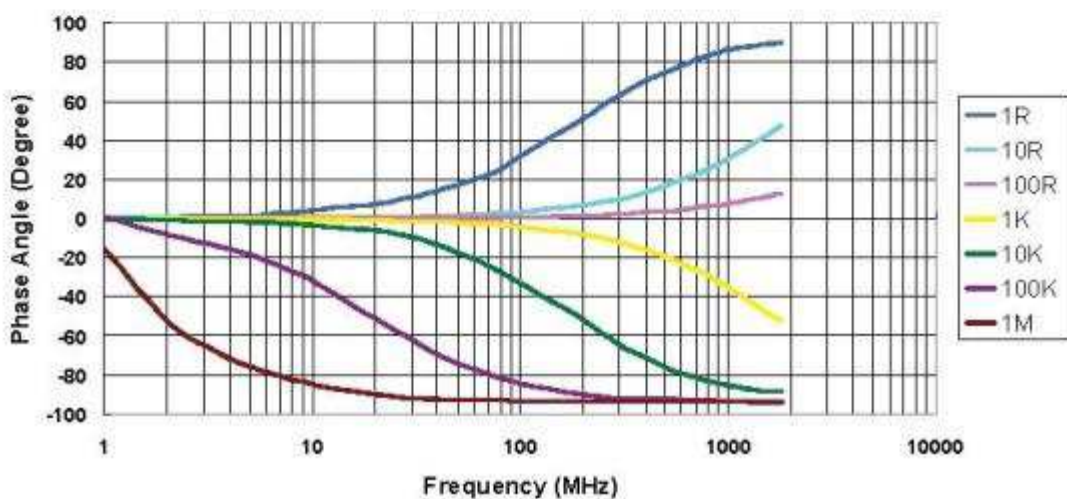

Frequency Vs Impedance

SMA0207

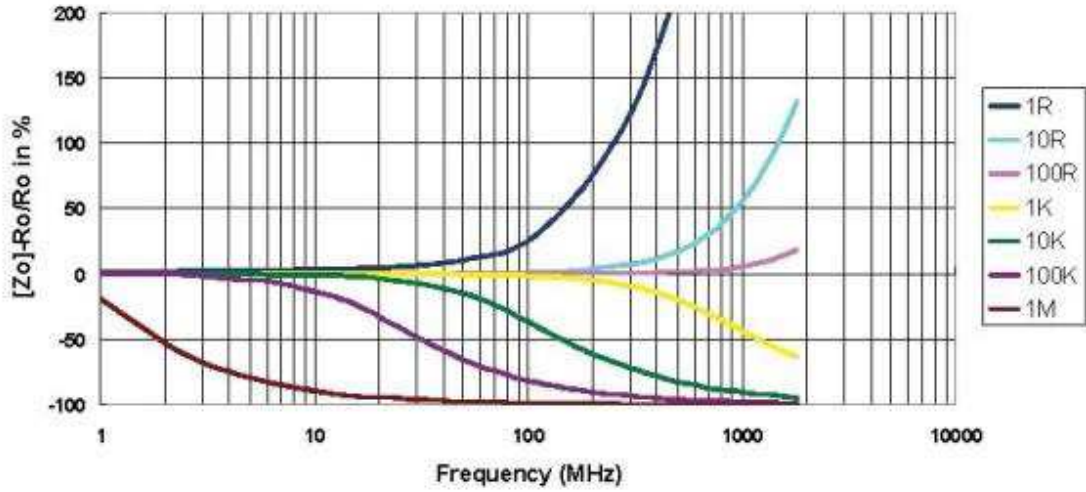

Frequency Vs Phase Angle

SMA0207

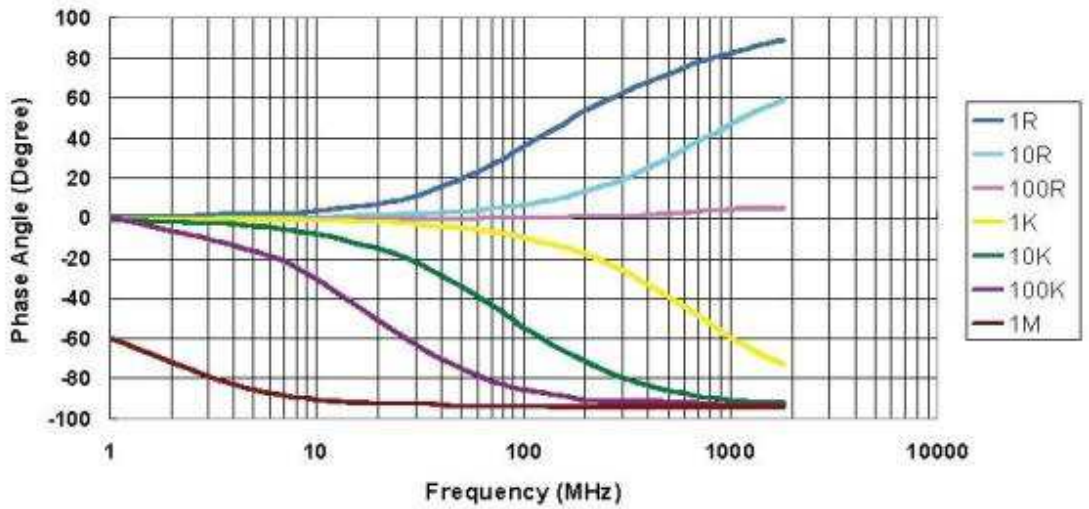



### Lightning Surge

Resistors are tested in accordance with IEC 60115-1 using both 1.2/50 $\mu$ s and 10/700 $\mu$ s pulse shapes. The limit of acceptance is a shift in resistance of less than 0.5% from the initial value.

1.2/50 $\mu$ s Lightning Surge

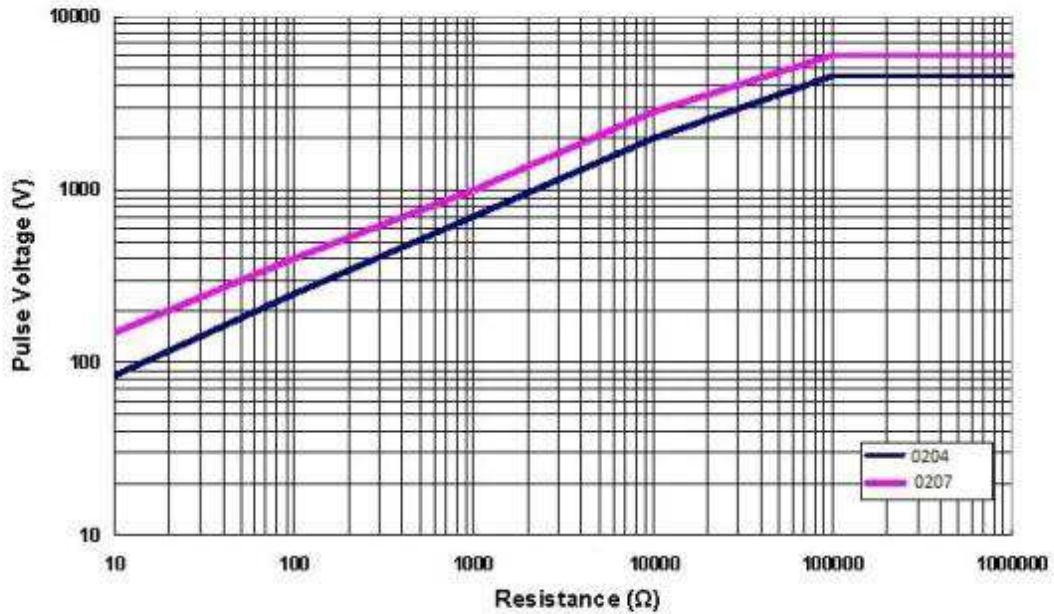

10/700 $\mu$ s Lightning Surge

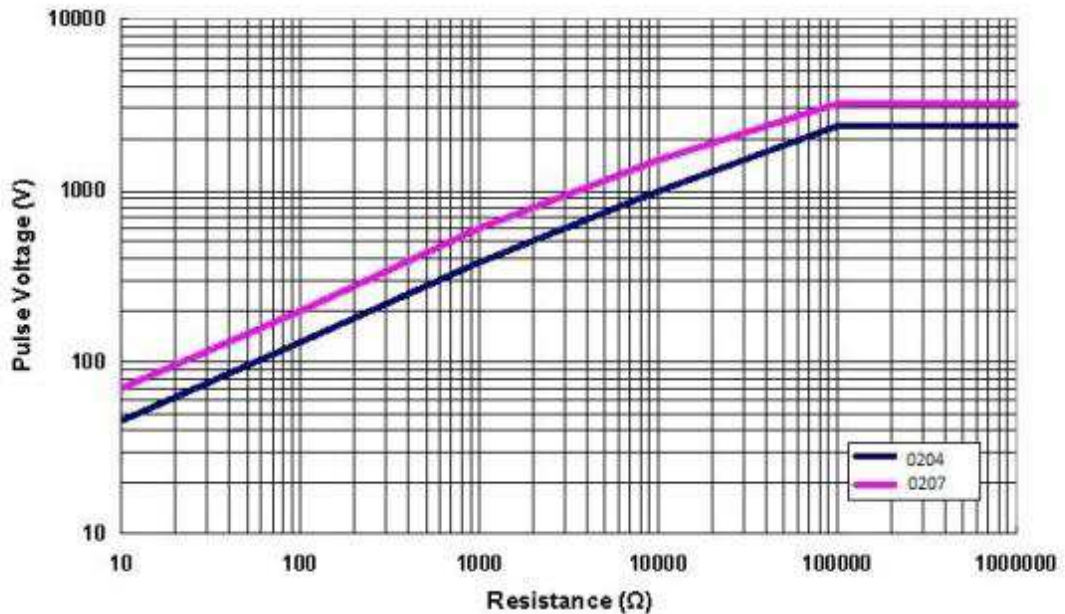

## Environmental Characteristics

Item	Requirement	Test Method
Temperature Coefficient of Resistance (T.C.R.)	As Spec	<b>JIS-C-5201-1 4.8</b> <b>IEC-60115-1 4.8</b> -55°C~+125°C, 25°C is the reference temperature
Short Time Overload	±(0.15%+0.05Ω)	<b>JIS-C-5201-1 4.13</b> <b>IEC-60115-1 4.13</b> RCWV*2.5 or Max. Overload Voltage whichever is lower for 5 seconds
Insulation Resistance	≥10G	<b>JIS-C-5201-1 4.6</b> <b>IEC-60115-1 4.6</b> Max. Overload Voltage for 1 minute
Endurance	±(0.5%+0.05Ω)	<b>JIS-C-5201-1 4.25</b> <b>IEC-60115-1 4.25.1</b> 70±2°C, RCWV for 1000 hrs with 1.5 hrs "ON" and 0.5 hr "OFF"
Damp Heat with Load	±(1.0%+0.05Ω)	<b>JIS-C-5201-1 4.24</b> <b>IEC-60115-1 4.24</b> 40± 2° C. 90- 95% R.H., RCWV for 1000 hrs with 1.5hrs "ON" and 0.5hr "OFF"
Dry Heat	±(1.0%+0.05Ω)	<b>JIS-C-5201-1 4.23</b> <b>IEC-60115-1 4.23.2</b> at +155°C for 1000 hrs
Bending Strength	±(0.5%+0.05Ω)	<b>JIS-C-5201-1 4.33</b> <b>IEC-60115-1 4.33</b> Bending once for 5 seconds with 2mm
Solderability	95% min. coverage	<b>JIS-C-5201-1 4.17</b> <b>IEC-60115-1 4.17</b> 245±5°C for 3 seconds
Resistance to Soldering Heat	±(0.5%+0.05Ω)	<b>JIS-C-5201-1 4.18</b> <b>IEC-60115-1 4.18</b> 260±5°C for 10 seconds
Voltage Proof	No breakdown or flashover	<b>JIS-C-5201-1 4.7</b> <b>IEC-60115-1 4.7</b> 1.42 times Max. Operating Voltage for 1 minute
Leaching	Individual leaching area ≤5% Total leaching area ≤ 10%	<b>JIS-C-5201-1 4.18</b> <b>IEC-60068-2-58 8.2.1</b> 260±5°C for 30 seconds
Rapid Change of Temperature	±(0.5%+0.05Ω)	<b>JIS-C-5201-1 4.19</b> <b>IEC-60115-1 4.19</b> -55°C to +125°C, 1000 cycles

RCWV(Rated Continuous Working Voltage)=V(P\*R) or Max. Operating Voltage whichever is lower.

Storage Temperature: 15~28°C; Humidity < 80%RH



**Packaging**

**Packaging Quantity and Reel Specification**

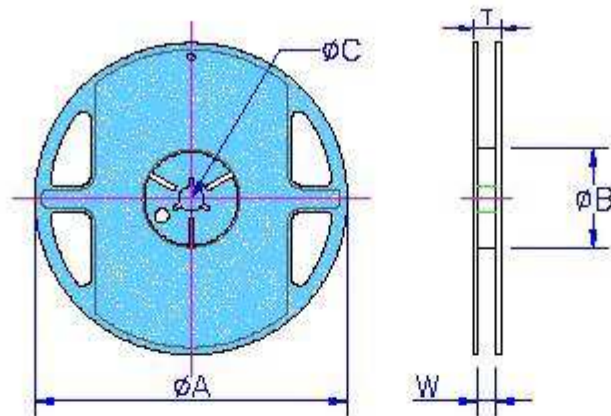

Size	Reel Diameter	ØA (mm)	ØB (mm)	ØC (mm)	W (mm)	T (mm)	Emboss Plastic Tape (EA)
0204	7"	178.5±1.5	60.0+1.0	13.0±0.2	9.0±0.5	12.5±0.5	3,000
0207	7"	178.5±1.5	60.0+1.0	13.0±0.2	13.0±0.5	15.5±0.5	2,000

**Embossed Plastic Tape Specification**

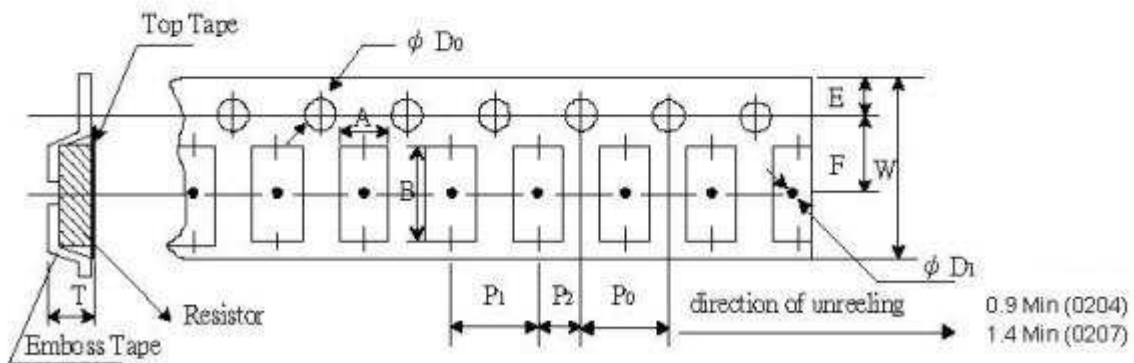

Size	A (mm)	B (mm)	W (mm)	E (mm)	F (mm)	P0 (mm)	P1 (mm)	P2 (mm)	ØD0 (mm)	T (mm)
	±0.10	±0.10	±0.10	±0.10	±0.05	±0.10	±0.10	±0.05	±0.10	±0.10
0204	1.55	3.65	8.0	1.75	3.50	4.00	4.00	2.00	1.50	1.80
0207	2.40	6.15	12.0	1.75	5.50	4.00	4.00	2.00	1.50	2.70

**Marking**

**E-24**

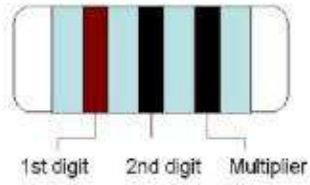

**E-96**

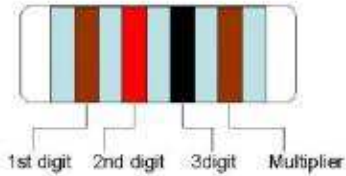

Color	Digit	Multiplier
Silver	-	10 <sup>-2</sup>
Gold	-	10 <sup>-1</sup>
Black	0	10 <sup>0</sup>
Brown	1	10 <sup>1</sup>
Red	2	10 <sup>2</sup>
Orange	3	10 <sup>3</sup>
Yellow	4	10 <sup>4</sup>
Green	5	10 <sup>5</sup>
Blue	6	10 <sup>6</sup>
Violet	7	10 <sup>7</sup>
Grey	8	10 <sup>8</sup>
White	9	10 <sup>9</sup>

**How To Order**

SMA	0204	B	T	N	X	100R
Common Part	Size	Tolerance	Packaging	TCR	Power Rating	Resistance Codes
SMA MELF Resistor	0204 0207	B - 0.1% C - 0.25% D - 0.5% F - 1% J - 5%	T - Tape and Reel	B - ±10PPM/°C N - ±15PPM/°C C - ±25PPM/°C D - ±50PPM/°C E - ±100PPM/°C	T - 1W U - 0.5W X - 0.4W V - 0.25W	R10 - 0.1Ω 10R - 10Ω 100R - 100Ω 1K0 - 1,000Ω 10K - 10,000Ω 1M0 - 1,000,000Ω

While TE has made every reasonable effort to ensure the accuracy of the information in this Data Sheet, TE does not guarantee that it is error-free, nor does TE make any other representation, warranty or guarantee that the information is accurate, correct, reliable or current. TE reserves the right to make any adjustments to the information contained herein at any time without notice. TE expressly disclaims all implied warranties regarding the information contained herein, including, but not limited to, any implied warranties of merchantability or fitness for a particular purpose. The dimensions in this data sheet are for reference purposes only and are subject to change without notice. Specifications are subject to change without notice. Consult TE for the latest dimensions and design specifications.