

3D VIEW

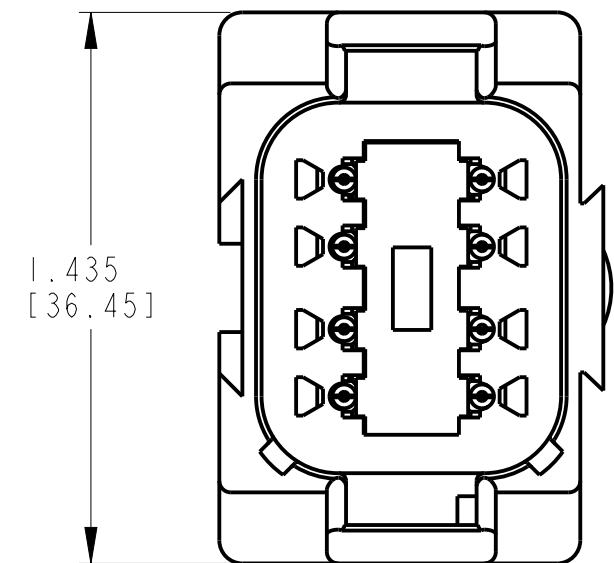
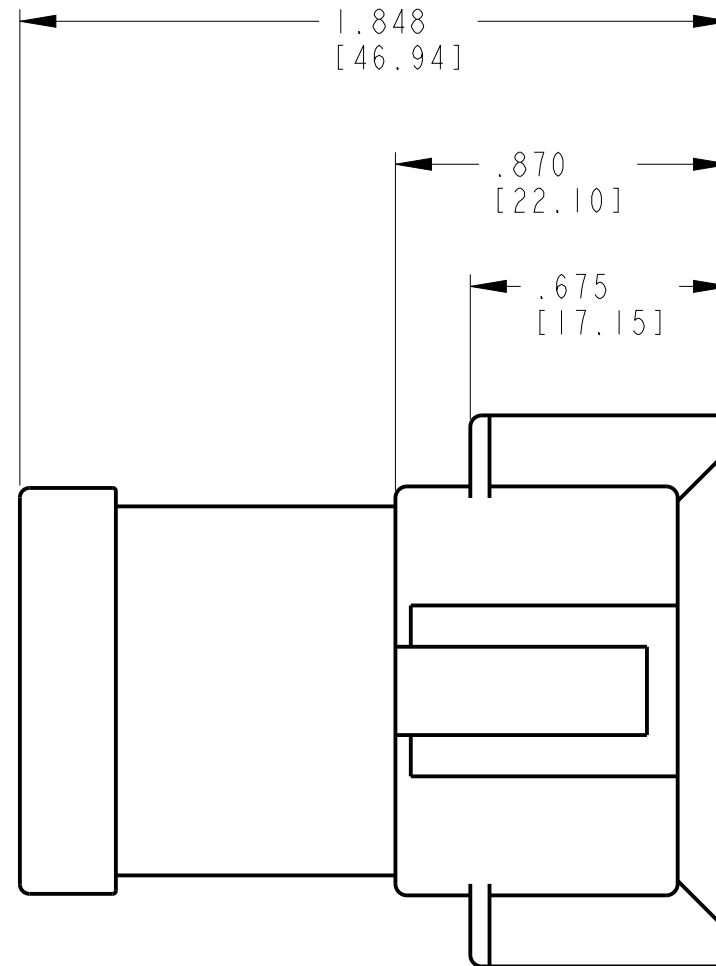
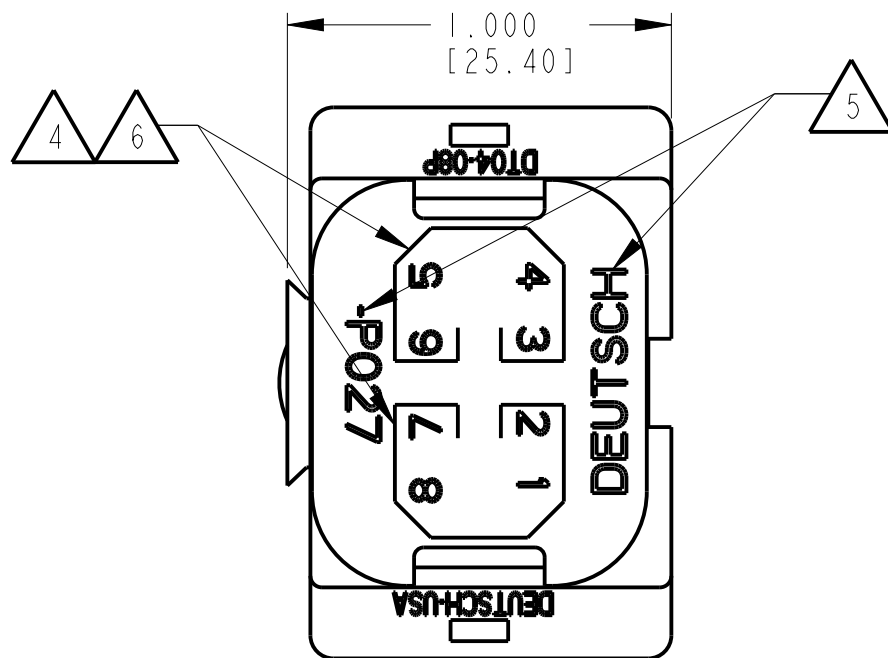
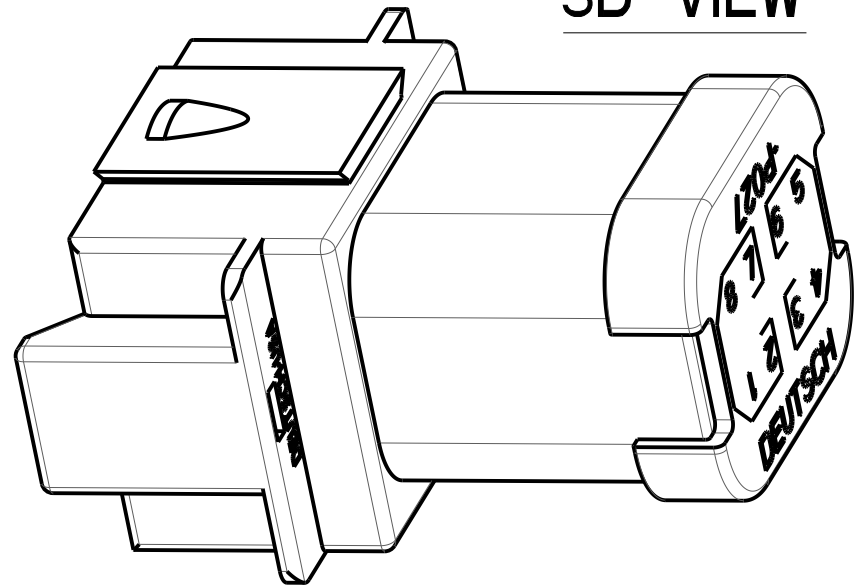

REV
A DT04-08P*-P027

REVISIONS			
SYM	DESCRIPTION	DATE	APPROVED
A	NEW RELEASE PER ECO-13-003363	02/13/13	D.M.

- 5. ORIENTATION OF "DEUTSCH" AND "-P027" TO BE OPTIONAL.
- 4. BORDER SIGNIFIES THAT PINS 1,2,7,8 AND PINS 3,4,5,6 ARE BUSSED TOGETHER WITH 4 PIN BUSBARS.
- 3. THIS RECEPTACLE MATES WITH DT06-08S*-**** PLUG.
(* = A,B,C,D KEY ARRANGEMENTS; **** = ALL MODIFICATIONS).
CONSULT FACTORY FOR MODIFICATIONS.
- 2. DIMENSIONS ARE ±.025[0.63] UNLESS OTHERWISE SPECIFIED.

NOTES: DIMENSIONS ARE IN INCHES [MILLIMETERS].

- 6. THE 4 PIN BUSBAR HAS A MAXIMUM CURRENT RATING OF 26 AMPS.

SIGNATURE & DATE	
DR	A.MALAGON 06FEB13
CHK	A.MALAGON 13FEB13
PE	R.MESSENGER 13FEB13
APPD	D.MEYER 13FEB13
SCALE	NONE WT 25g

DT 8 WAY RECEPTACLE
(2) 4 PIN BUSBARS-GOLD PLATED

ENVELOPE

EP	MATL. CODE
 3850 INDUSTRIAL AVE. HEMET, CA 92545	
DEUTSCH INDUSTRIAL	
B DT04-08P*-P027	
DWG SIZE	SHEET 1 OF 2

REV
A DT04-08P*-P027

REVISIONS			
SYM	DESCRIPTION	DATE	APPROVED
A	SEE SHEET 1	02/13/13	D.M.

PART NO.
DT04-08PA-P027
KEY ARR. -A-
COLOR: GREY

PART NO.
DT04-08PB-P027
KEY ARR. -B-
COLOR: BLACK

PART NO.
DT04-08PC-P027
KEY ARR. -C-
COLOR: GREEN

PART NO.
DT04-08PD-P027
KEY ARR. -D-
COLOR: BROWN

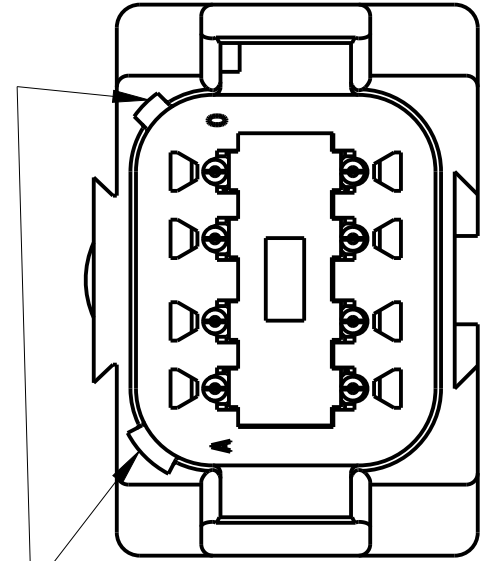

KEY -A-

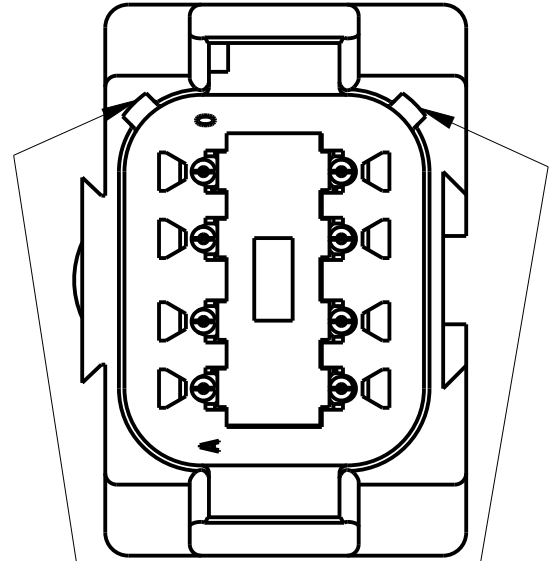

KEY -B-

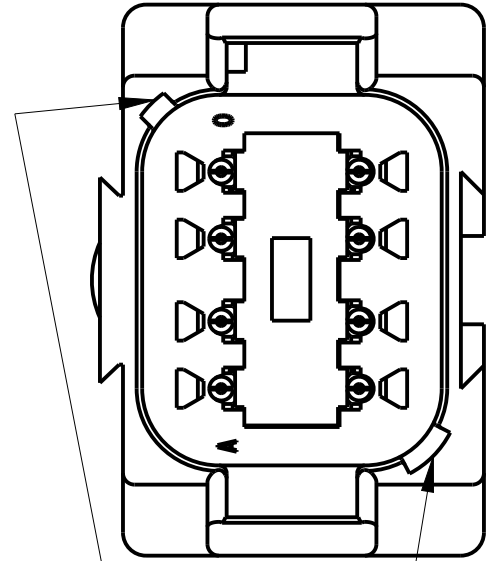

KEY -C-

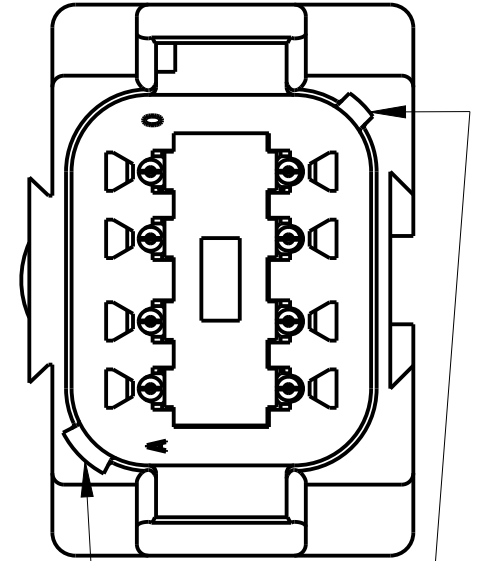

KEY -D-

NOTES:

SIGNATURE & DATE	
DR	A. MALAGON 06FEB13
CHK	A. MALAGON 13FEB13
PE	R. MESSENGER 13FEB13
APPD	D. MEYER 13FEB13
SCALE	NONE WT _____

DT 8 WAY RECEPTACLE
(2) 4 PIN BUSBARS-GOLD PLATED

ENVELOPE

EP	MATL. CODE
 3850 INDUSTRIAL AVE. HEMET, CA 92545	
B	DT04-08P*-P027
DWG SIZE	CODE 11139 SHEET 2 OF 2

