

THIS DRAWING IS UNPUBLISHED. RELEASED FOR PUBLICATION
 © COPYRIGHT BY TYCO ELECTRONICS CORPORATION. ALL RIGHTS RESERVED.

Loc		DIST		REVISIONS			
P	LTR	DESCRIPTION		DATE	DWN	APVD	
AJ	16	A		REV PER ECO 06-002539	07APR06	GB	JH

1. USE INSTRUCTION SHEET 408-1799-3.
2. PANEL THICKNESS: .031/.125.
3. CRIMPING TOOL: 69245-2.

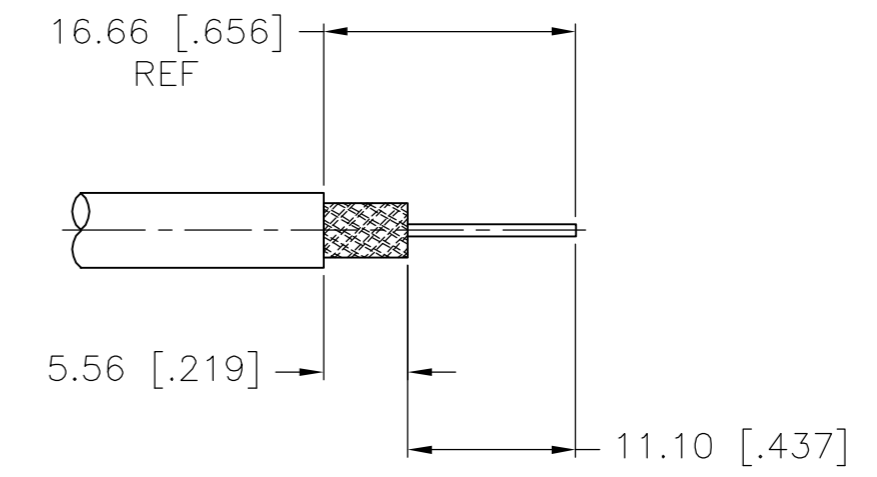
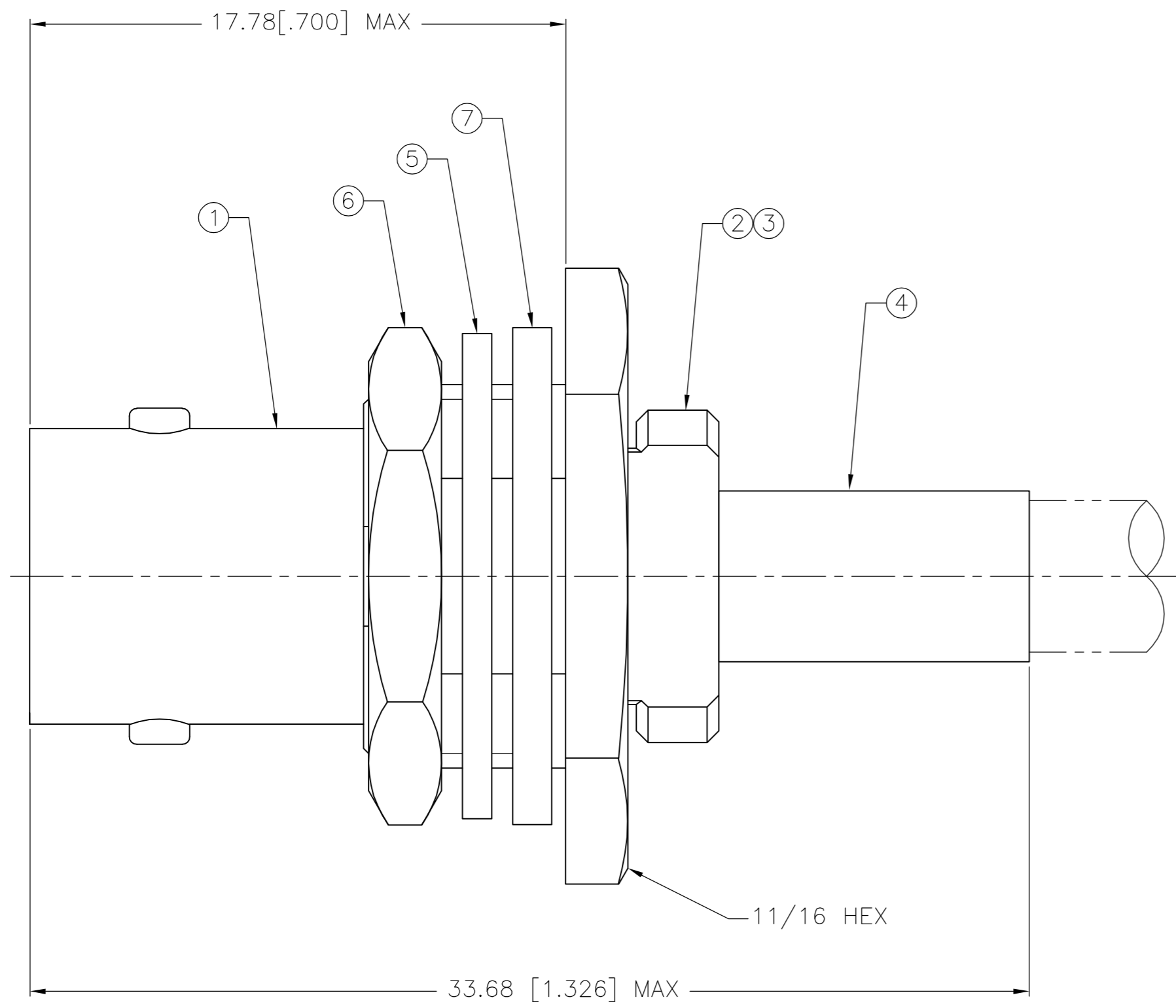

RECOMMENDED STRIP LENGTH SCALE 2:1

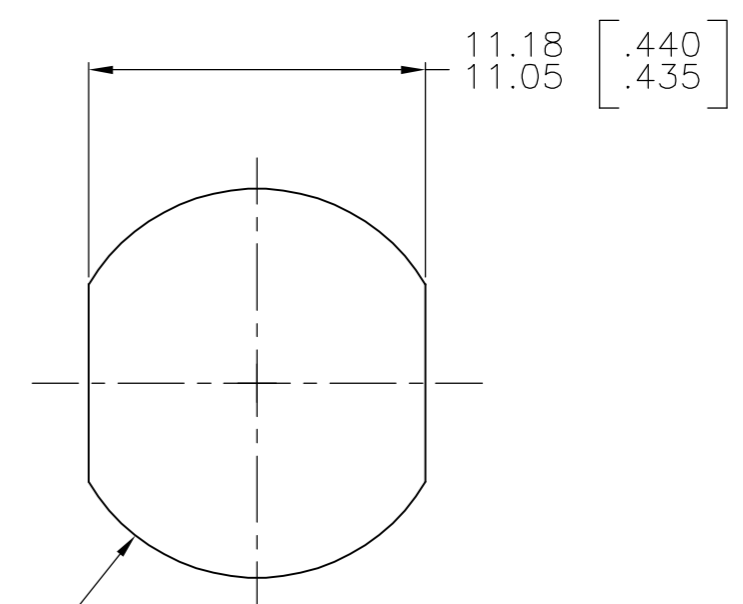

RECOMMENDED PANEL CUTOUT SCALE 4:1

RG-174/U & RG-188/U	329633	9-329631-0	9-329632-0	9-328666-3	9-50793-3	2-329106-1	9-329803-0	2-5330060-1
CABLE	⑦ GASKET QTY=1	⑥ JAM NUT QTY=1	⑤ LOCK WASHER QTY=1	④ FERRULE QTY=1	③ CRIMP END ASSEMBLY QTY=1	② GASKET QTY=1	① JACK ASSEMBLY, BULKHEAD QTY=1	PART NUMBER

THIS DRAWING IS A CONTROLLED DOCUMENT.

DIMENSIONS: mm [INCHES]	TOLERANCES UNLESS OTHERWISE SPECIFIED:	DWN B. MCMASTER 24OCT05	Tyco Electronics Corporation Harrisburg, PA 17105-3608
	0 PLC ± -	CHK J. HAVENER 24OCT05	
	1 PLC ± -	APVD J. HAVENER 24OCT05	
	2 PLC ± 0.41 [.016]	PRODUCT SPEC	
MATERIAL	FINISH	APPLICATION SPEC	NAME JACK, BULKHEAD, BNC, SINGLE CRIMP
		WEIGHT	SIZE A2
		CUSTOMER DRAWING	CAGE CODE 00779
			DRAWING NO C=5330060
			RESTRICTED TO
			SCALE 6:1
			SHEET 1 of 1
			REV A

5330060