

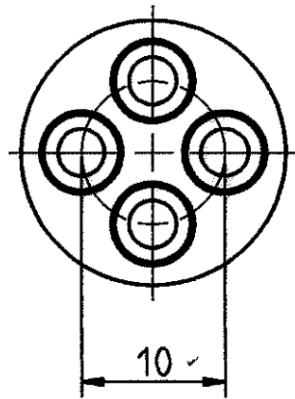

Copying of the document and giving it to other and the use or communication of the contents thereof, are forbidden without express authority. Offenders are liable to the payment of damages. All rights are reserved in the event of the grant of a patent or the registration of a utility model or design.

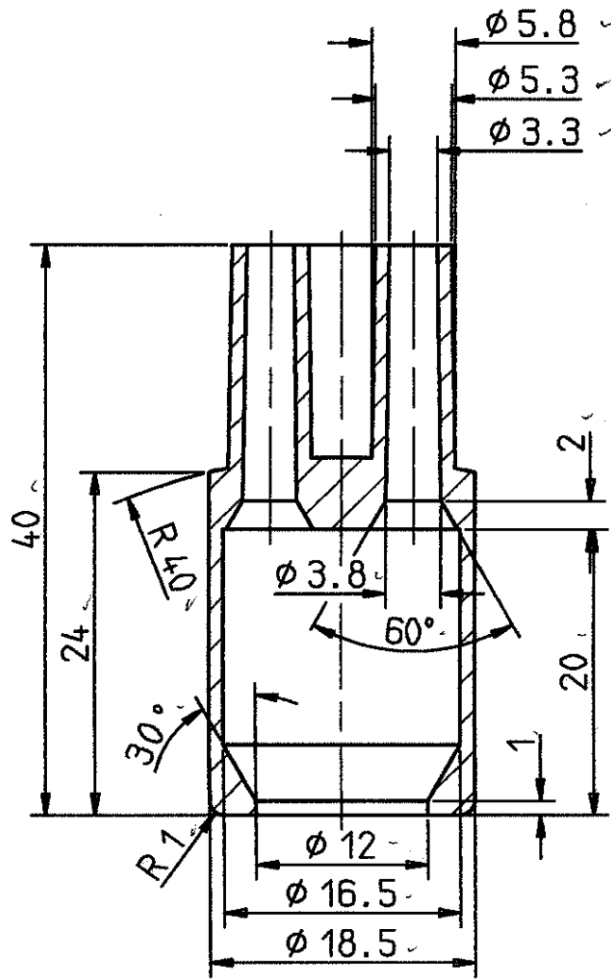

dimensions in mm

Customer Drawing							
				2020	DATE	NAME	GURO-CBO-4x4
				DRAWN	21.01.	Beckmann	
				CHECKED			
						Tyco Electronics Raychem GmbH Werk Berlin	NAMING: CD-GURO-CBO-4x4
REV.	MODIFICATION	DATE	N.	CAD NO.:		DRAWING NO.:	
1				2		3	
						4	
				REPLACEMENT FOR:			