

THIS DRAWING IS UNPUBLISHED. RELEASED FOR PUBLICATION 2007  
 © COPYRIGHT 2007 BY - ALL RIGHTS RESERVED.

LOC		DIST		REVISIONS			
P	LTR	DESCRIPTION		DATE	DWN	APVD	
	AI	REVISED		02FEB2021	F.Z	R.B	

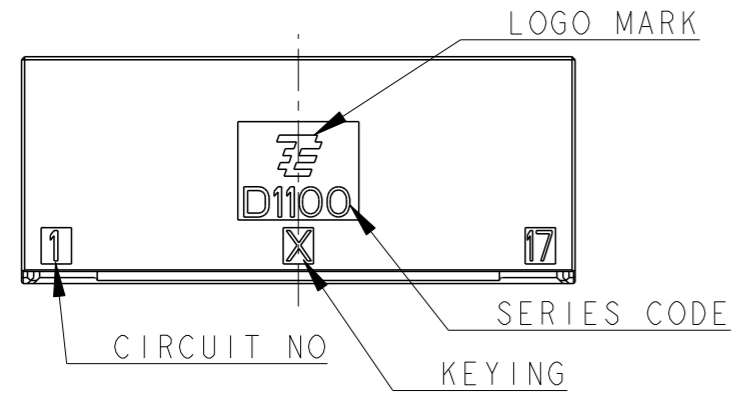
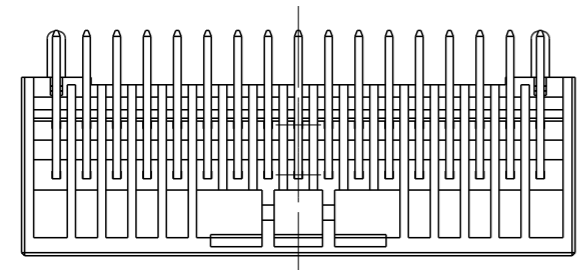
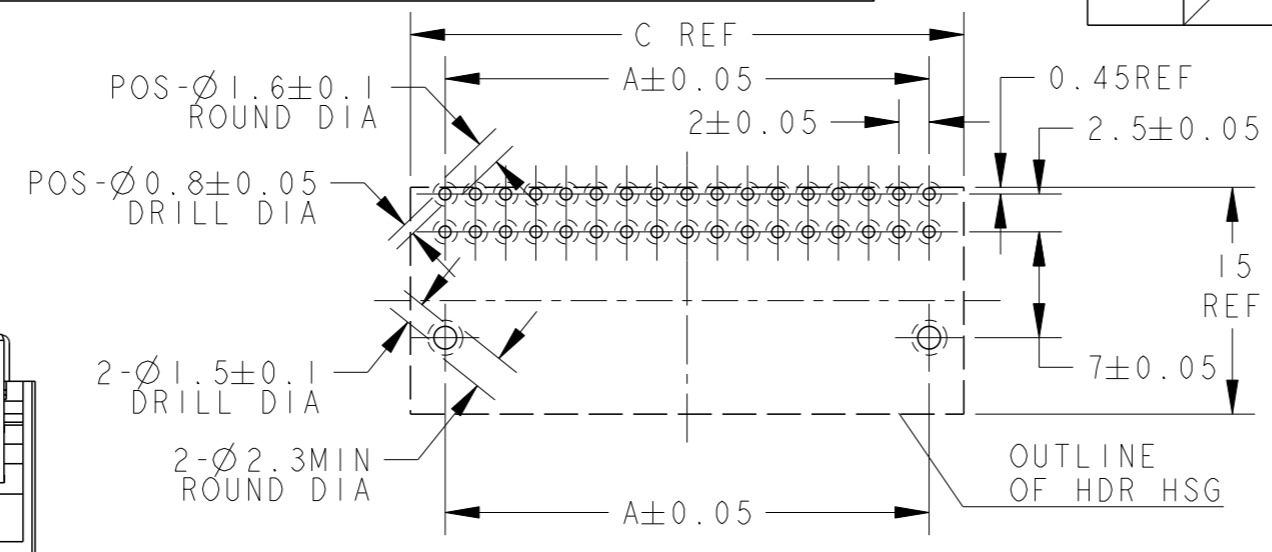

RECOMMEND PC BOARD HOLE PATTERN : CONNECTOR MOUNT SIDE (NOT ACCUMULATE TOLERANCE)  
 PC BOARD THICKNESS : 1.0~1.6±0.1

△. MATERIAL: HOUSING: GLASS FILED THERMO PLASTIC POLYESTER(94V-0), COLOR: BLACK  
 CONTACT: PRE-TIN COPPER ALLOY  
 RETENTION LEG: PRE-TIN COPPER ALLOY

2. THE SHAPE, SIZE AND POSITION OF THE CHARACTER SHOW THE OUTLINE. THEY DON'T SHOW DETAILS.

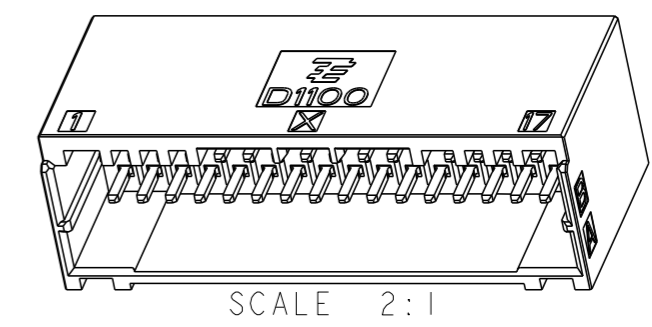
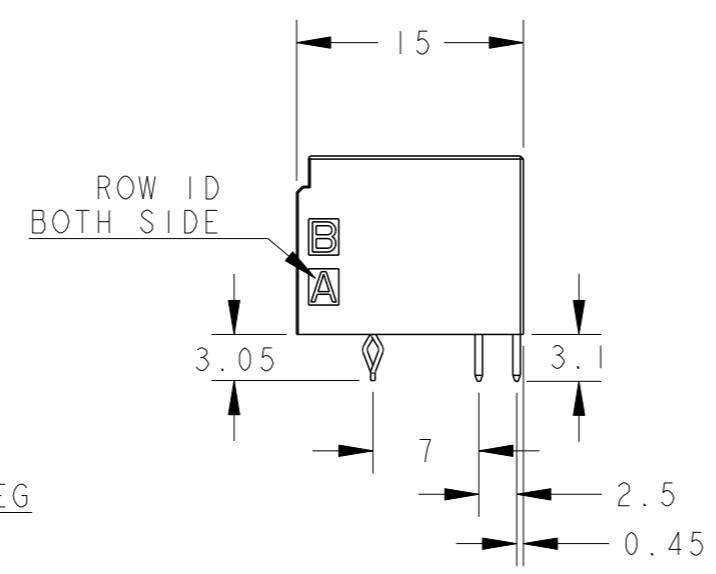
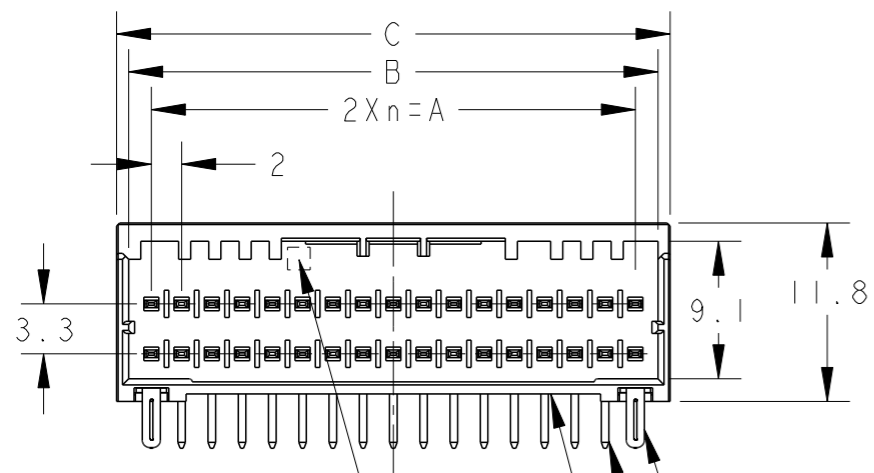

POS	KEY	n	A	B	C	FINISHED	PART NO
40	X	19	38.0	41.0	42.6	PRE-TIN	I-2372488-0
34	X	16	32.0	35.0	36.6	PRE-TIN	I-2372488-7
30	X	14	28.0	31.0	32.6	PRE-TIN	I-2372488-5
28	X	13	26.0	29.0	30.6	PRE-TIN	I-2372488-4
26	X	12	24.0	27.0	28.6	PRE-TIN	I-2372488-3

CAVITY MARK (ALPHABET: CAPITAL LETTER)  
 HDR HSG  
 RETENTION LEG  
 CONTACT

34POS(X-KEY): I-2372488-7

THIS DRAWING IS A CONTROLLED DOCUMENT.		DWN	26-May-20		TE Connectivity		
		CHK	26-May-20				
		APVD	26-May-20		NAME		
		RICK.BIAN			DYNAMIC D1100D 2.0mmPITCH		
		RICK.BIAN			HDR ASSY, H-TYPE PRE-TIN		
		108-137366			22-40POS		
		114-5377			SIZE	CAGE CODE	DRAWING NO
		MATERIAL			A3	00779	C=2372488
		FINISH			SCALE		SHEET
		-			2:1		1 OF 2
		CUSTOMER DRAWING			REV		
					AI		

Printed on 3 Feb 2021 10:55 (China Standard Time) from TE304429

4

3

2

1

THIS DRAWING IS UNPUBLISHED.

RELEASED FOR PUBLICATION

2007

LOC

DIST

REVISIONS

© COPYRIGHT 2007 BY -

ALL RIGHTS RESERVED.

P

LTR

DESCRIPTION

DATE

DWN

APVD

SEE SHEET 1 OF 2

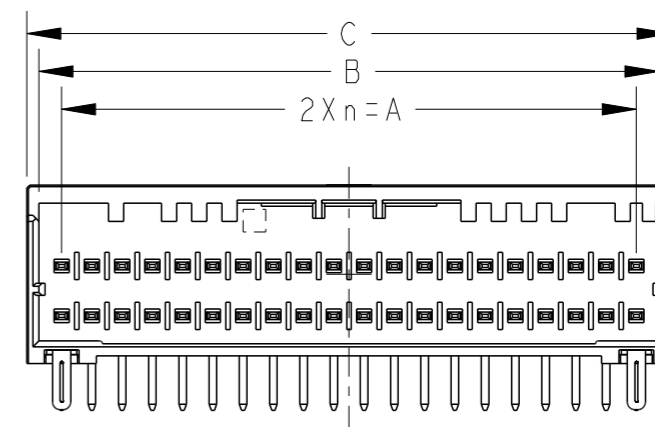
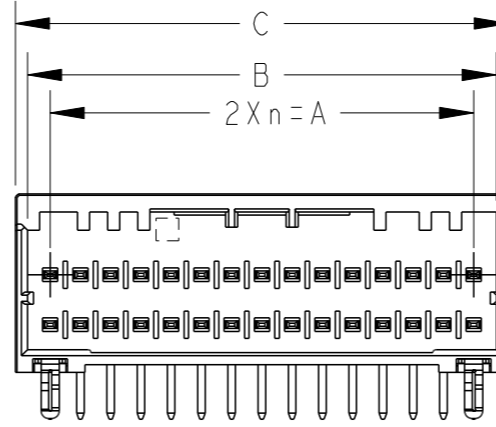
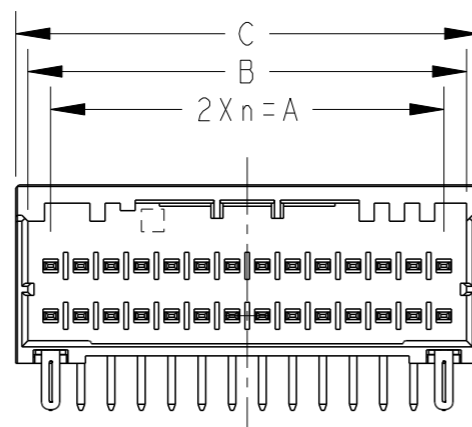
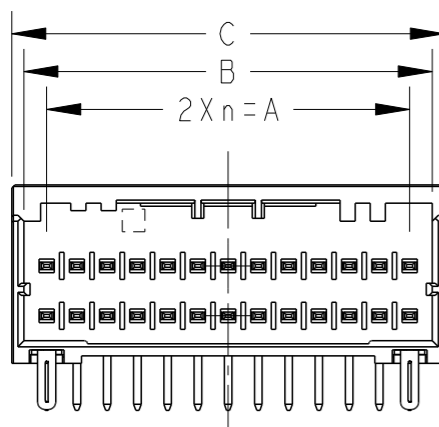
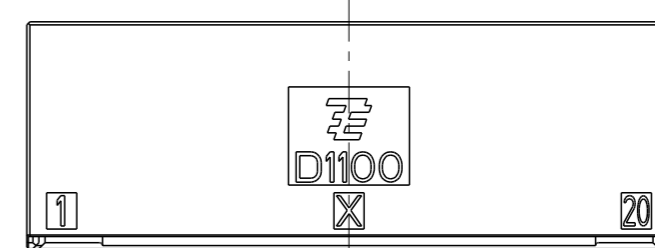
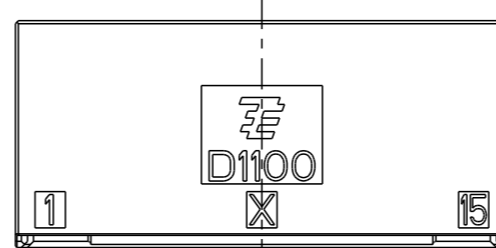
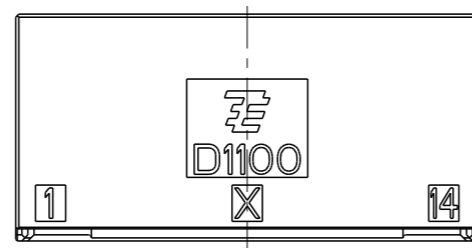
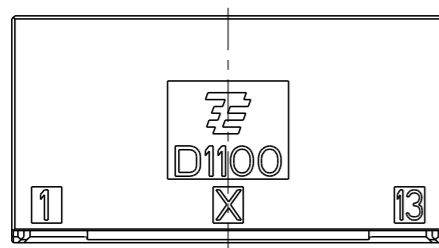
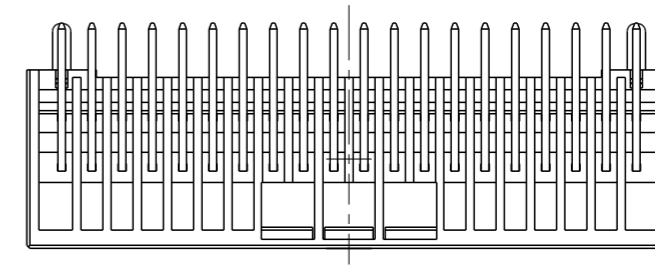
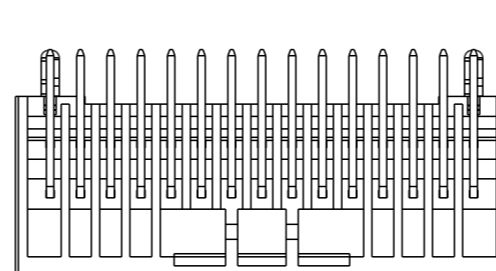
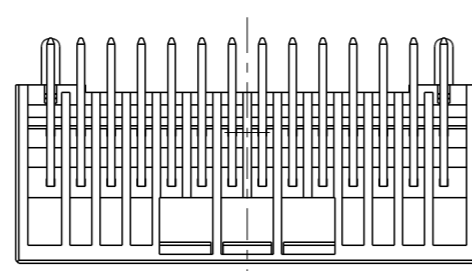
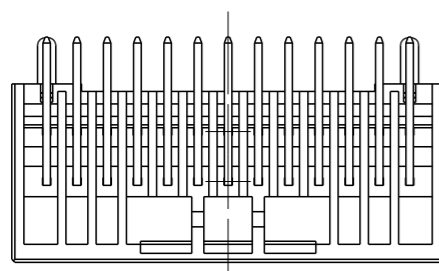

26POS(X-KEY): 1-2372488-3

28POS(X-KEY): 1-2372488-4

30POS(X-KEY): 1-2372488-5

40POS(X-KEY): 1-2372488-0

THIS DRAWING IS A CONTROLLED DOCUMENT.

DWN 03-Feb-21

CHK FISHER, ZHU 03-Feb-21

APVD RICK, BIAN 03-Feb-21

APVD RICK, BIAN 03-Feb-21

PRODUCT SPEC

108-137366

APPLICATION SPEC

114-5377

WEIGHT

CUSTOMER DRAWING



TE Connectivity

DYNAMIC D1100D 2.0mm PITCH HDR ASSY, H-TYPE PRE-TIN 22-40POS

SIZE A3 CAGE CODE 00779 DRAWING NO C=2372488 RESTRICTED TO

SCALE 2:1 SHEET 2 OF 2 REV A1

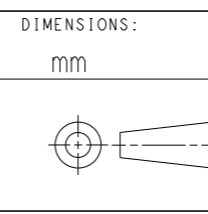

DIMENSIONS:		TOLERANCES UNLESS OTHERWISE SPECIFIED:	
mm			
0 PLC	±	0 PLC	±
1 PLC	±0.5	1 PLC	±0.5
2 PLC	±0.13	2 PLC	±0.13
3 PLC	±0.013	3 PLC	±0.013
4 PLC	±0.0001	4 PLC	±0.0001
ANGLES	±	ANGLES	±
MATERIAL	-	FINISH	-

Printed on 3 Feb 2021 10:55 (China Standard Time) from TE304429