

THIS DRAWING IS UNPUBLISHED.

RELEASED FOR PUBLICATION

20

REVISIONS

© COPYRIGHT 20 BY -

ALL RIGHTS RESERVED.

P	LTR	DESCRIPTION	DATE	DWN	APVD
A		FIRST RELEASE	19JUL2016	A.D	SY.W
A3		ECR-17-004532	19JUN2017	A.D	I.Y
B		ECR-17-015556	21NOV2017	A.D	E.J
C		ECR-20-012381	26FEB2021	A.D	Z.J

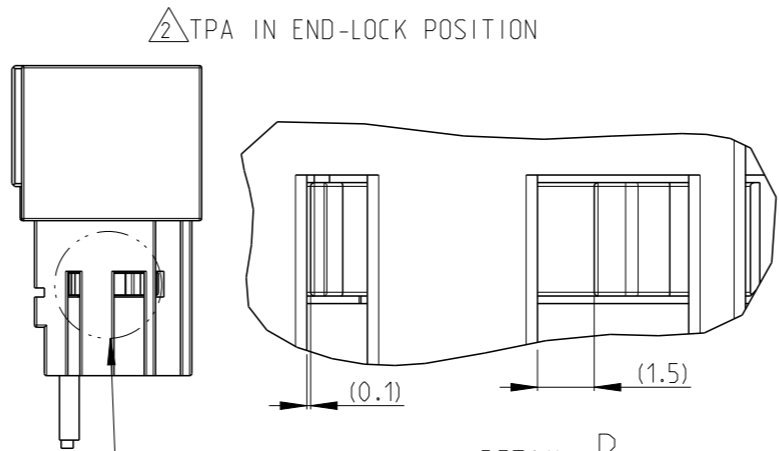
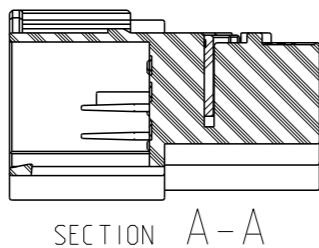
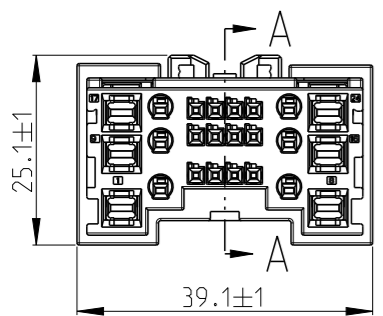

DETAIL B SCALE 5:1

NOTES:
 1. TPA IN PRE-LOCK POSITION WHEN DELIVERY.
 2. TPA IN END-LOCK POSITION.
 3. PRODUCT SPEC: 108-101431, APPLICATION SPEC 114-101077.
 4. MATING PART IS *-2298622-*

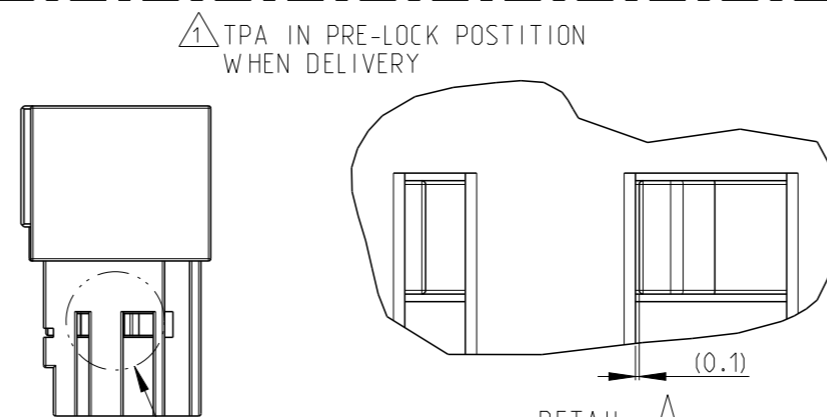
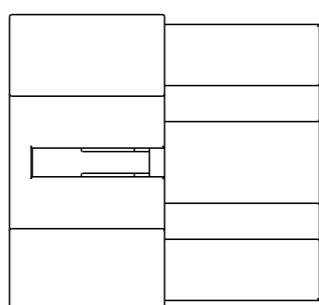
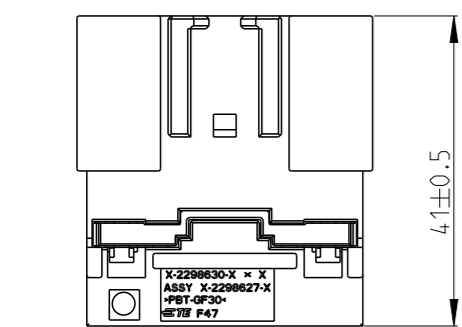

DETAIL A SCALE 5:1

CONTACT SIZE (MM)	CABLE SIZE (MM ²)	INSULATION DIA (MM)	CONTACT	PLATING
0.64	0.22-0.35	1.1-1.4	2297494-1	PRE-TIN
	0.5-0.75	1.4-1.9	2293362-1	PRE-TIN
1.2	0.22-0.35	1.1-1.4	2294463-1	PRE-TIN
	0.5-0.75	1.4-1.9	2294463-2	PRE-TIN
	1.0-1.5	1.9-2.4	2294463-3	PRE-TIN
2.8	0.5-1.0	1.4-2.1	2-964294-1	PRE-TIN
	>1.0-2.5	2.2-3.0	2-964296-1	PRE-TIN
	>2.5-4.0	2.7-3.7	1-968946-1	PRE-TIN
			2-968946-1	PRE-TIN

THE CODE WITH 0° CLIP CAN MATE WITH INDIVIDUAL CLIP
 THE CODE WITH 180° CLIP CAN'T MATE WITH INDIVIDUAL CLIP

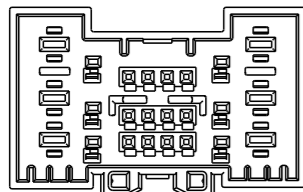

X-2298627-1 CODINGA

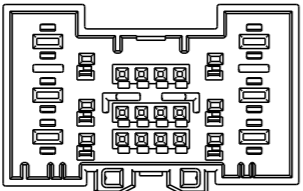

X-2298627-2 CODINGB

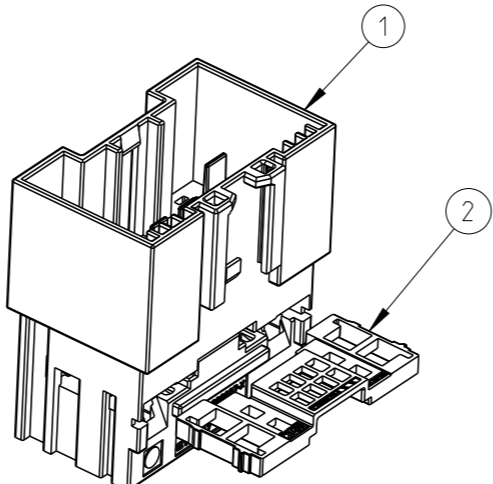

QTY	DESCRIPTION	COLOR	MATERIAL	*-1	*-2	1*-1	1*-2	2*-1
2	TPA TAB HSG, 24POS, HYBRID	NATURE	PBT-GF30	1	1	1	1	1
1	24POS, HYBRID, TAB HSG, UNSLD, COD B CLIP 180°	NATURE	PBT-GF30				1	
	24POS, HYBRID, TAB HSG, UNSLD, COD A CLIP 180°	BLACK				1		
	24POS, HYBRID, TAB HSG, UNSLD, COD B CLIP 0°	NATURE						
	24POS, HYBRID, TAB HSG, UNSLD, COD A CLIP 0°	BROWN						1
		BLACK		1				
N	DESCRIBE	COLOR	MATERIAL	*-1	*-2	1*-1	1*-2	2*-1
0				ASSY P/N				

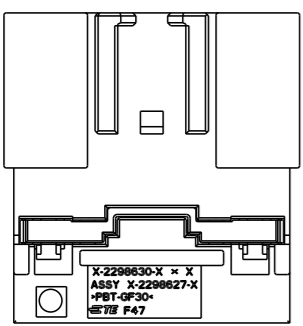

2298627-X
2-2298627-X
CLIP 0°

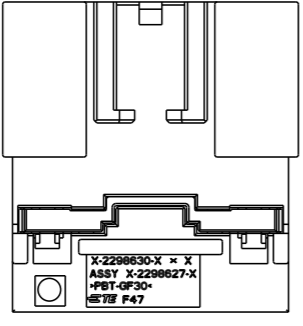

1-2298627-X
CLIP 180°

THIS DRAWING IS A CONTROLLED DOCUMENT.

DIMENSIONS:	TOLERANCES UNLESS OTHERWISE SPECIFIED:
mm	
Ø PLC	±
1 PLC	±0.1
2 PLC	±0.01
3 PLC	±0.001
4 PLC	±0.0001
ANGLES	±
MATERIAL	FINISH
-	-
-	-

DWN	A.DANG	19JUL2016
CHK	SY.WANG	19JUL2016
APVD	SY.WANG	19JUL2016
PRODUCT SPEC	-	-
APPLICATION SPEC	-	-
WEIGHT	-	-
CUSTOMER DRAWING		

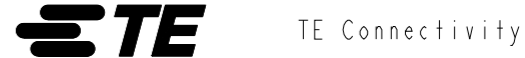

NAME 24POS, HYBRID, TAB HSG ASSY, UNSLD			
SIZE	CAGE CODE	DRAWING NO	RESTRICTED TO
A3	-	©-2298627	-
SCALE		SHEET	REV
1:1		1 OF 1	C