

LOC		DIST		REVISIONS			
P	LTM	DESCRIPTION	DATE	DWN	APVD		
C		REVISED PER ECR-21-100678	08APR2021	SS	VS		
D		REVISED PER ECR-23-219171	29JUN2023	MC	DS		

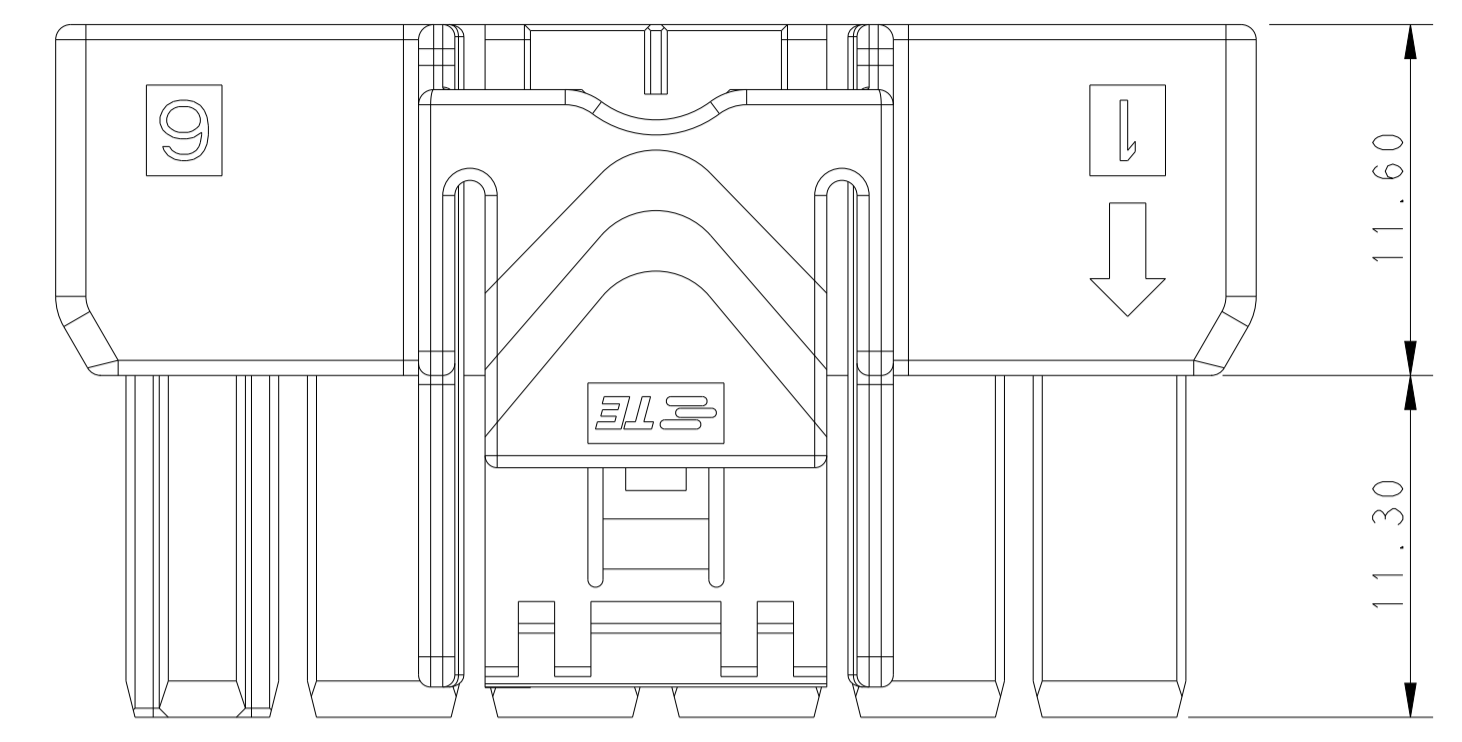

POS.	DIM. A
2*6	39.70
2*5	33.70
2*4	27.70
2*3	21.70

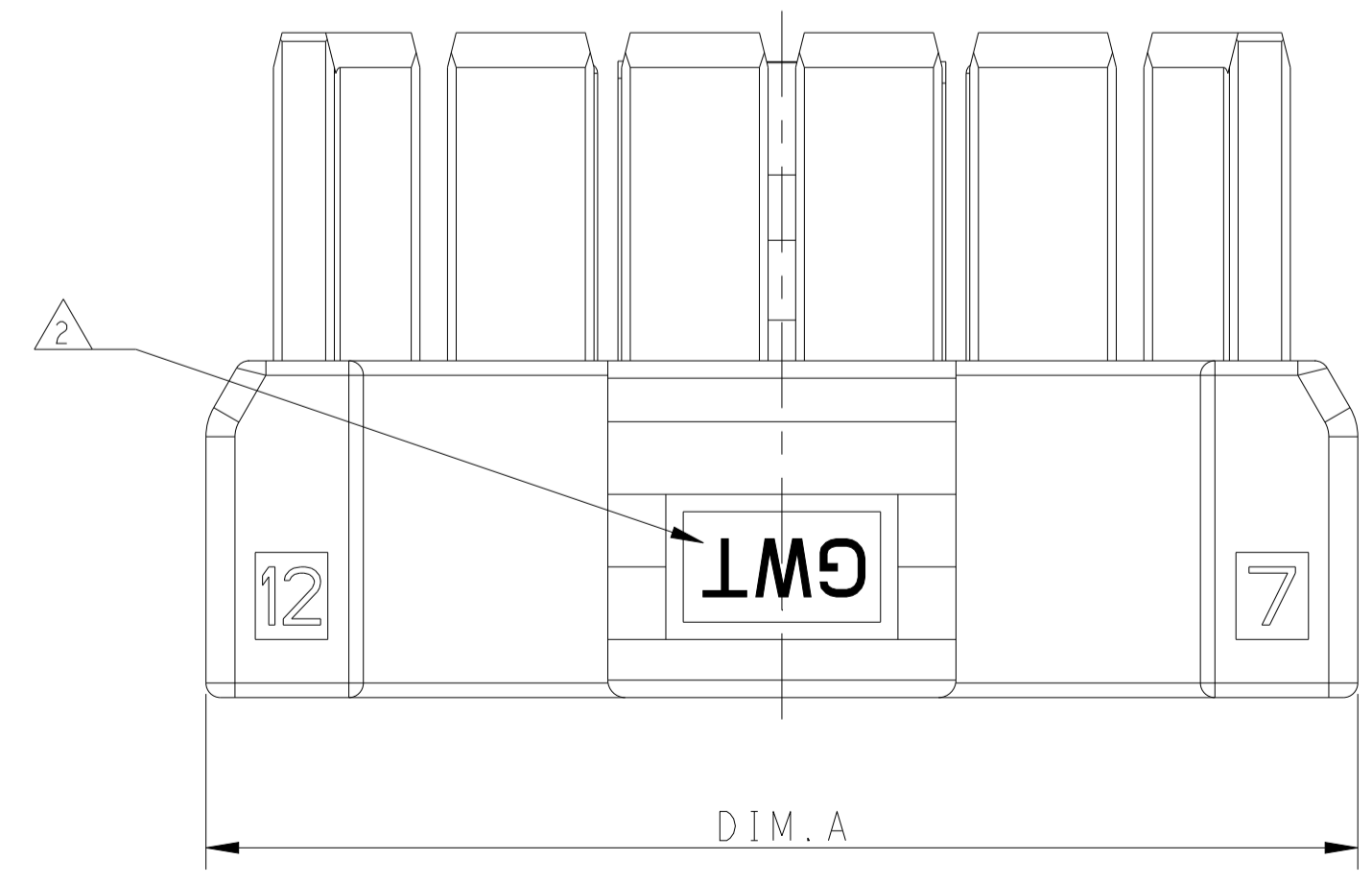
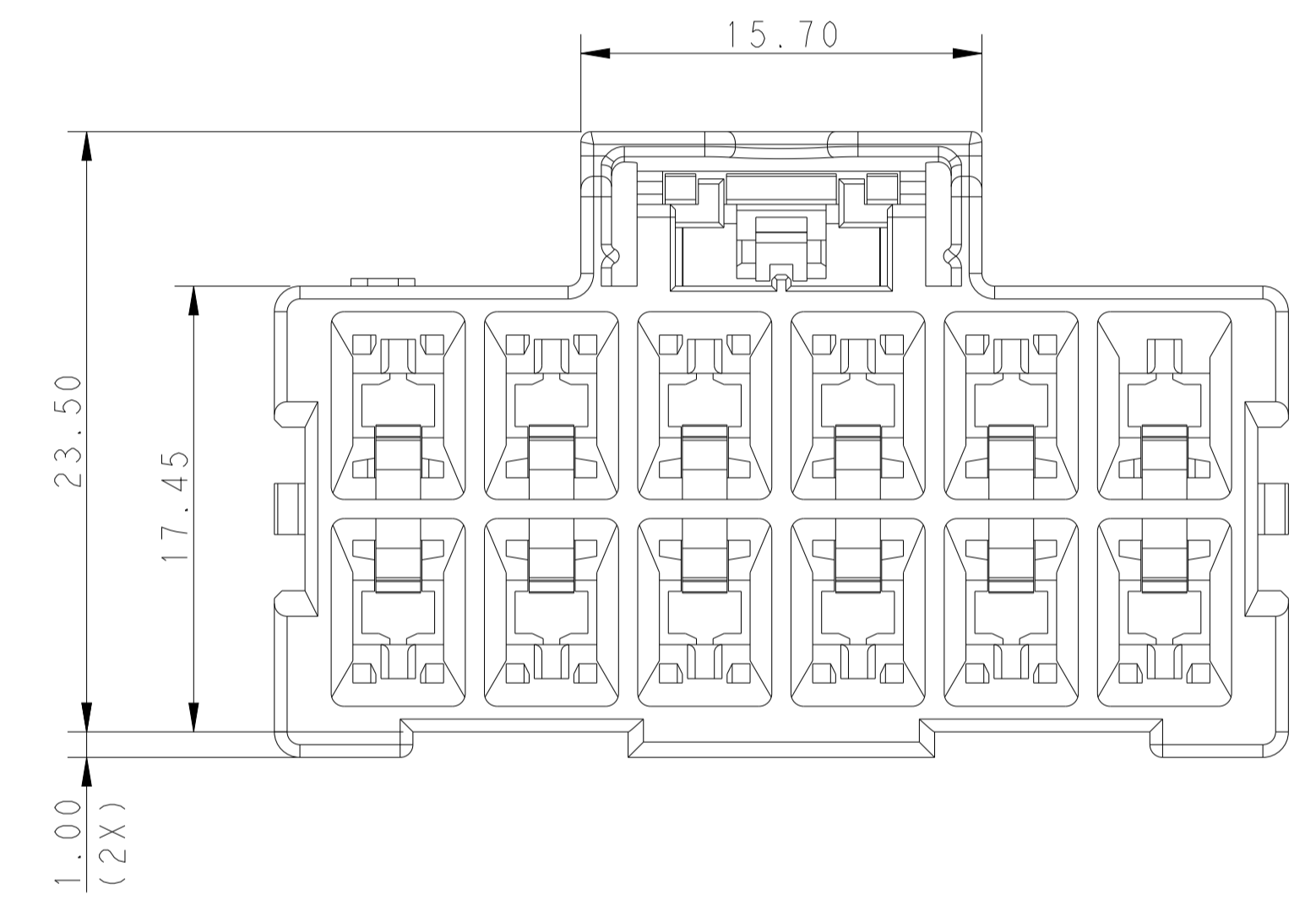
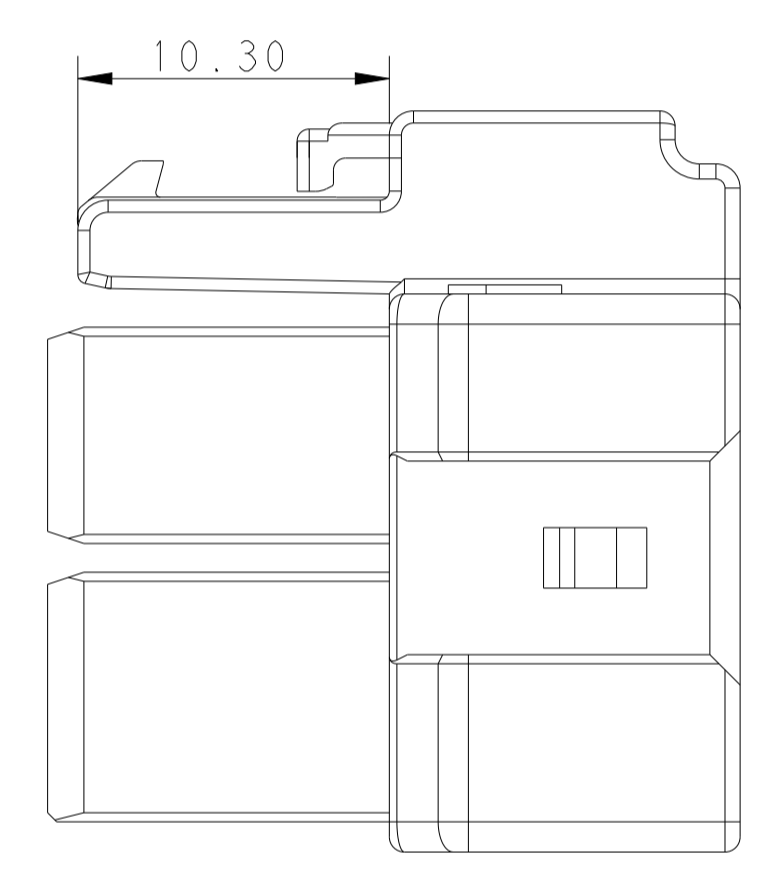
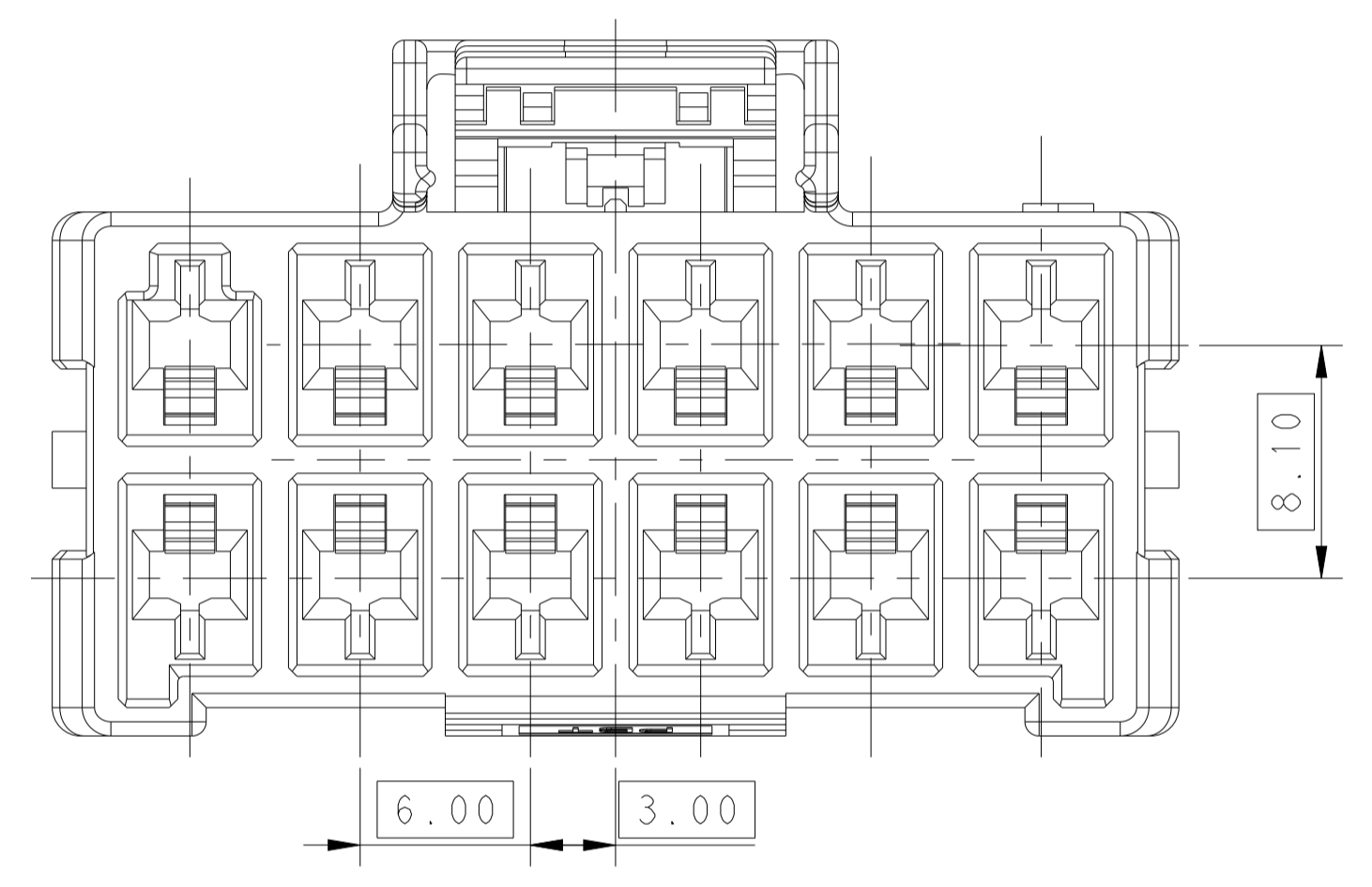

- NOTE
- MATERIAL:
 - LEVEL A: PA66, COMPLY WITH GLOW WIRE REQUIREMENTS FOR PARTS OF NON-METALLIC MATERIAL SUPPORTING A CURRENT-CARRYING CONNECTION DETAILED IN IEC 60335-1, SECTION 30 (GWT), UL 94V-0
 - LEVEL B: PBT, HOT WIRE IGNITION (HWI) VERSION ARE MOLDED IN A RESIN THAT COMPLIES WITH TE PENDING HOT WIRE IGNITION TEST AND ARE RECOMMENDED FOR USE WITH HWI HOUSINGS THAT ALSO COMPLY, UL 94V-0
 - MATERIAL MARK:
 - LEVEL A:GWT,LEVEL B:HWT
 - APPLICABLE CONTACT P/N
 RECEPTACLE CONTACT: 1971237/1971779/81/83/85/87-*, 2238066-*
 - MATING CONN, P/N
 CAP HSG: *-2232359/264-
 TPA: *-1971778-*

THIS DRAWING IS A CONTROLLED DOCUMENT.		DWN	TOMMY WU	26MAR2013	TE Connectivity PLUG HOUSING, DOUBLE ROW POWER TRIPLE LOCK	
DIMENSIONS:		CHK	HAPYE WU	26MAR2013		
TOLERANCES UNLESS OTHERWISE SPECIFIED:		APVD	YUHONG MAO	26MAR2013		
mm		NAME		PRODUCT SPEC		
0 PLC	±	SIZE		CAGE CODE	DRAWING NO	RESTRICTED TO
1 PLC	±0.35	A1		00779	2232266	
2 PLC	±0.25	SCALE			SHEET	1 OF 2
3 PLC	±	Customer Drawing				REV D
4 PLC	±					
ANGLES	±					
FINISH						

LOC		DIST		REVISIONS			
P	LTN	DESCRIPTION	DATE	OWN	APVD		
-	-	SEE SHEET 1	-	-	-		

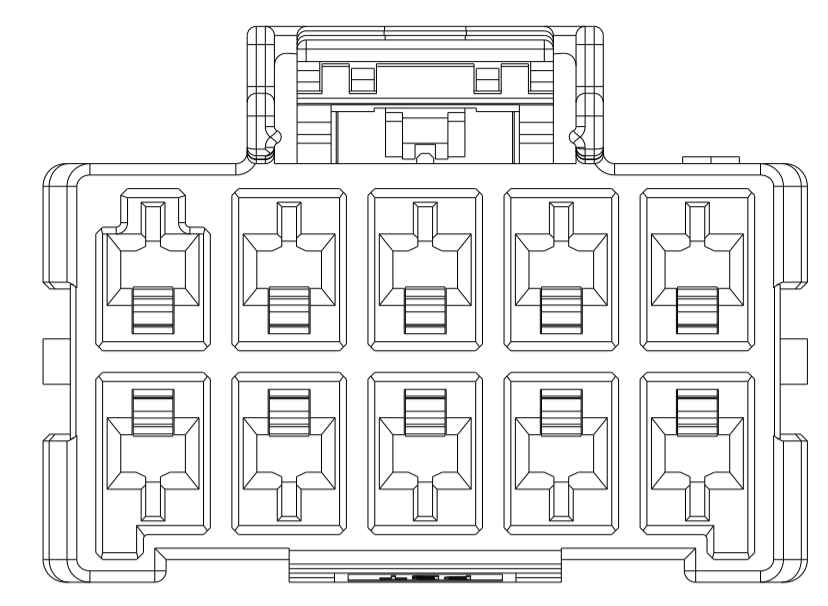
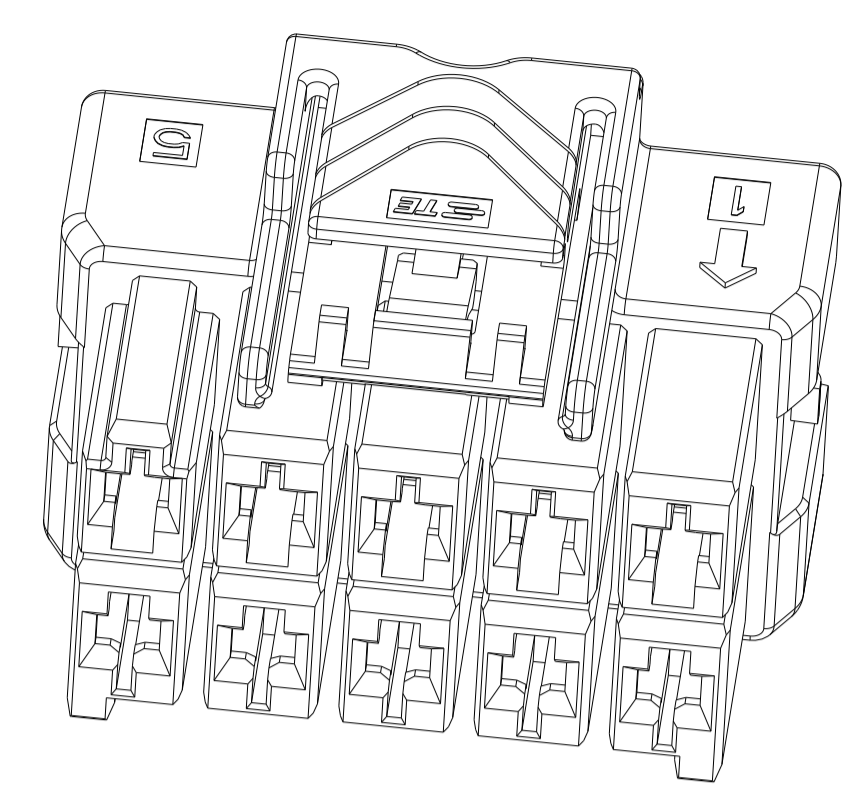

2*5 POSITIONS

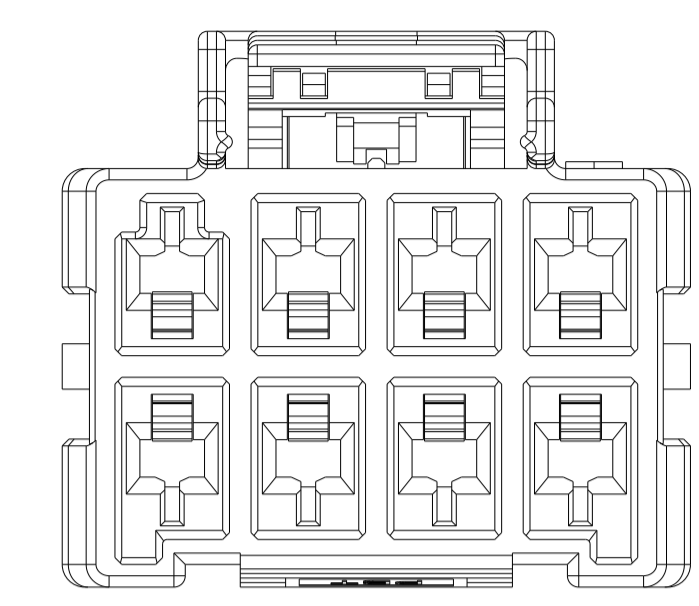
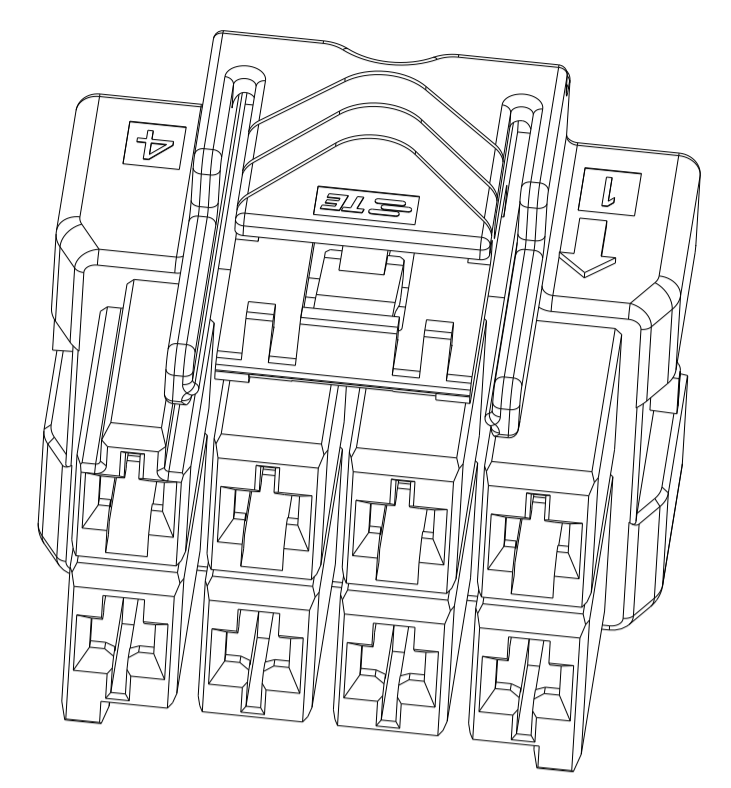

2*4 POSITIONS

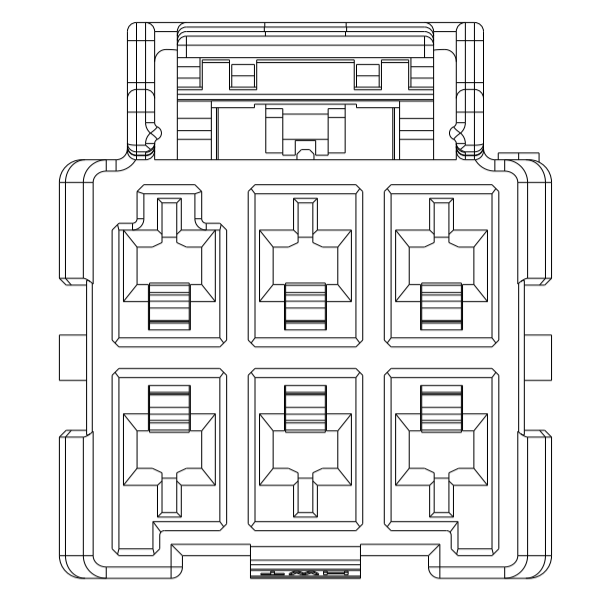
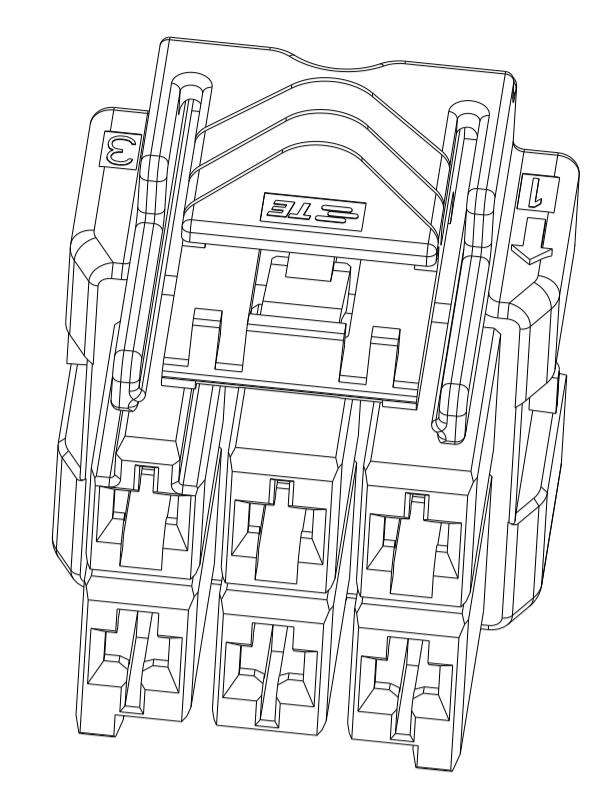

2*3 POSITIONS

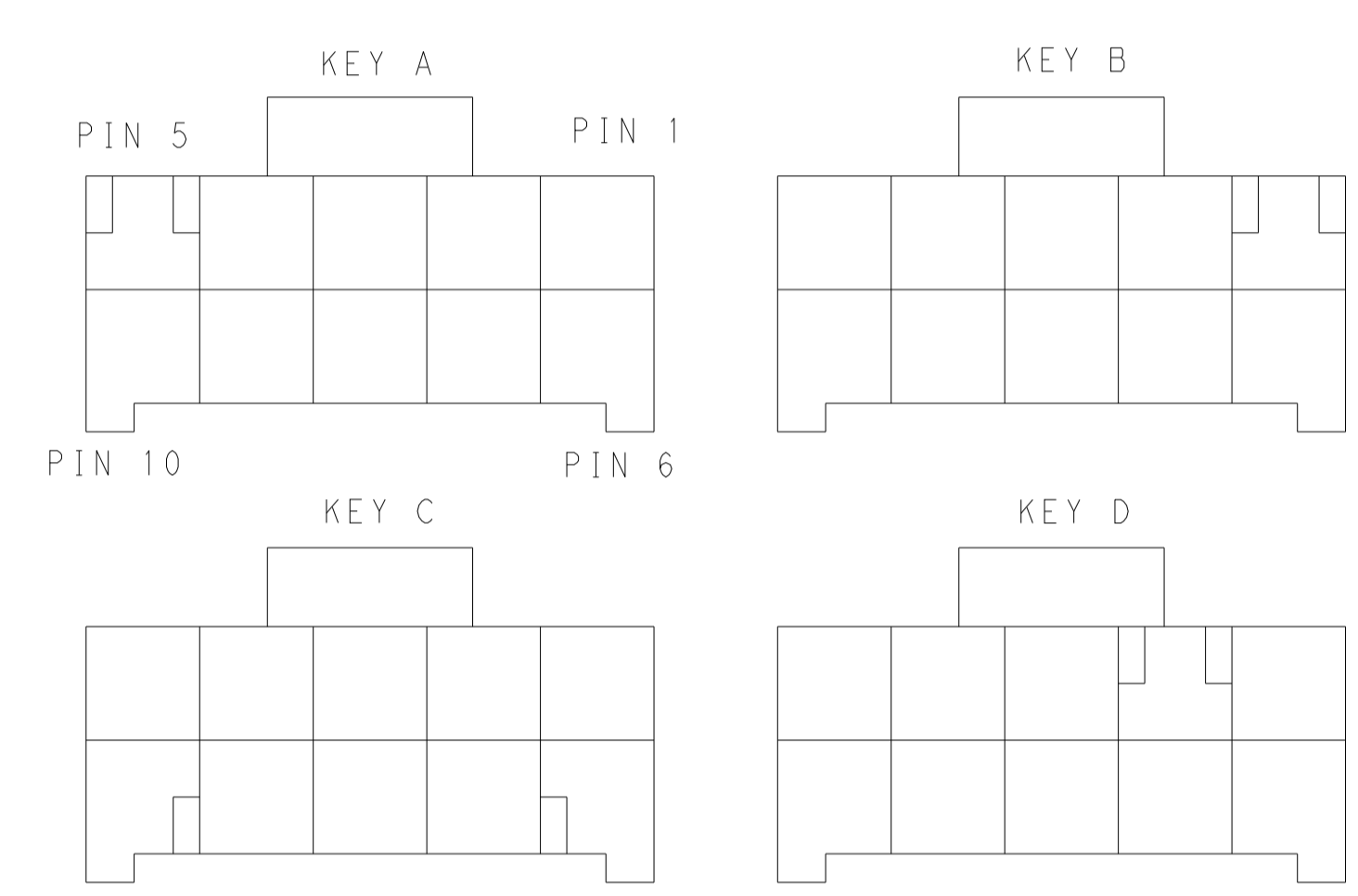

KEYING FOR 2*5 POS.

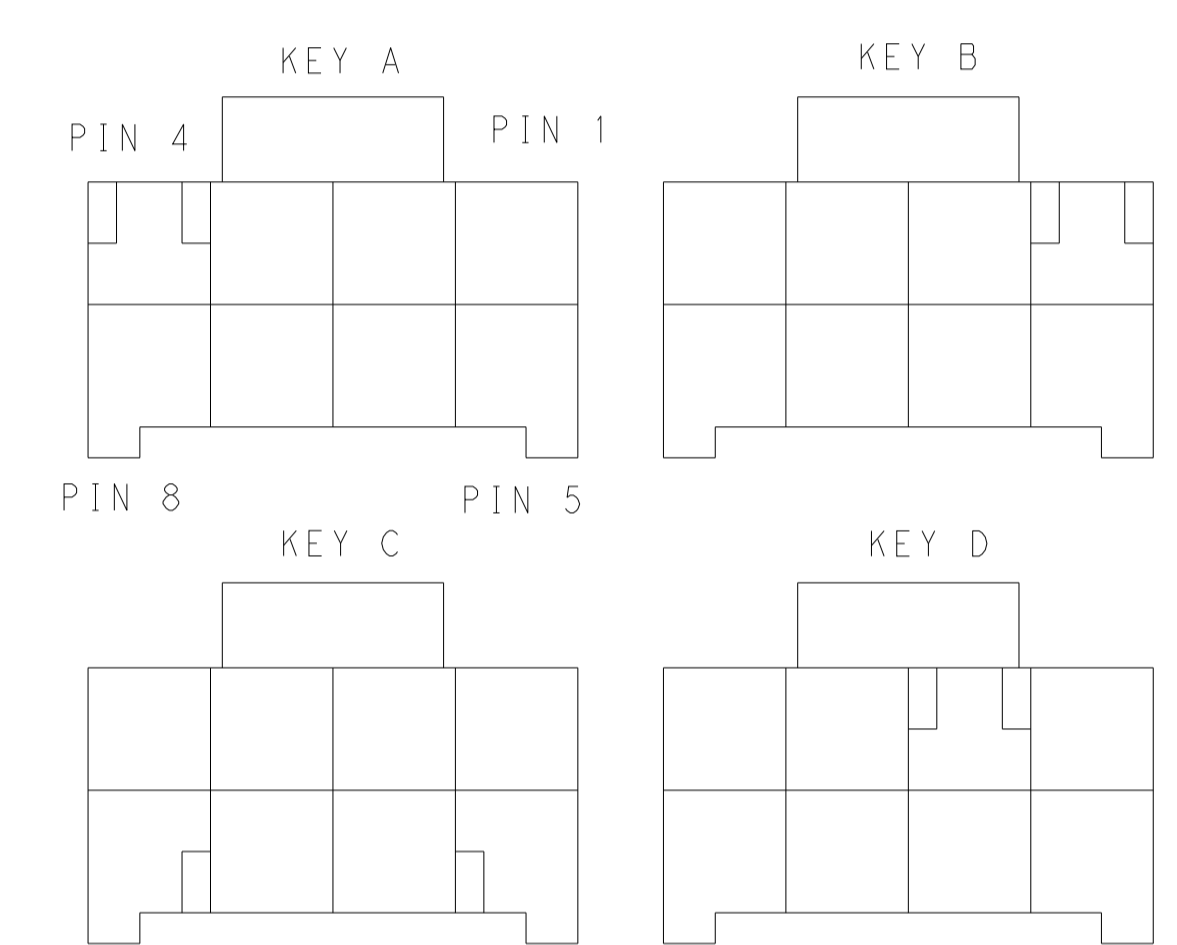

KEYING FOR 2*4 POS.

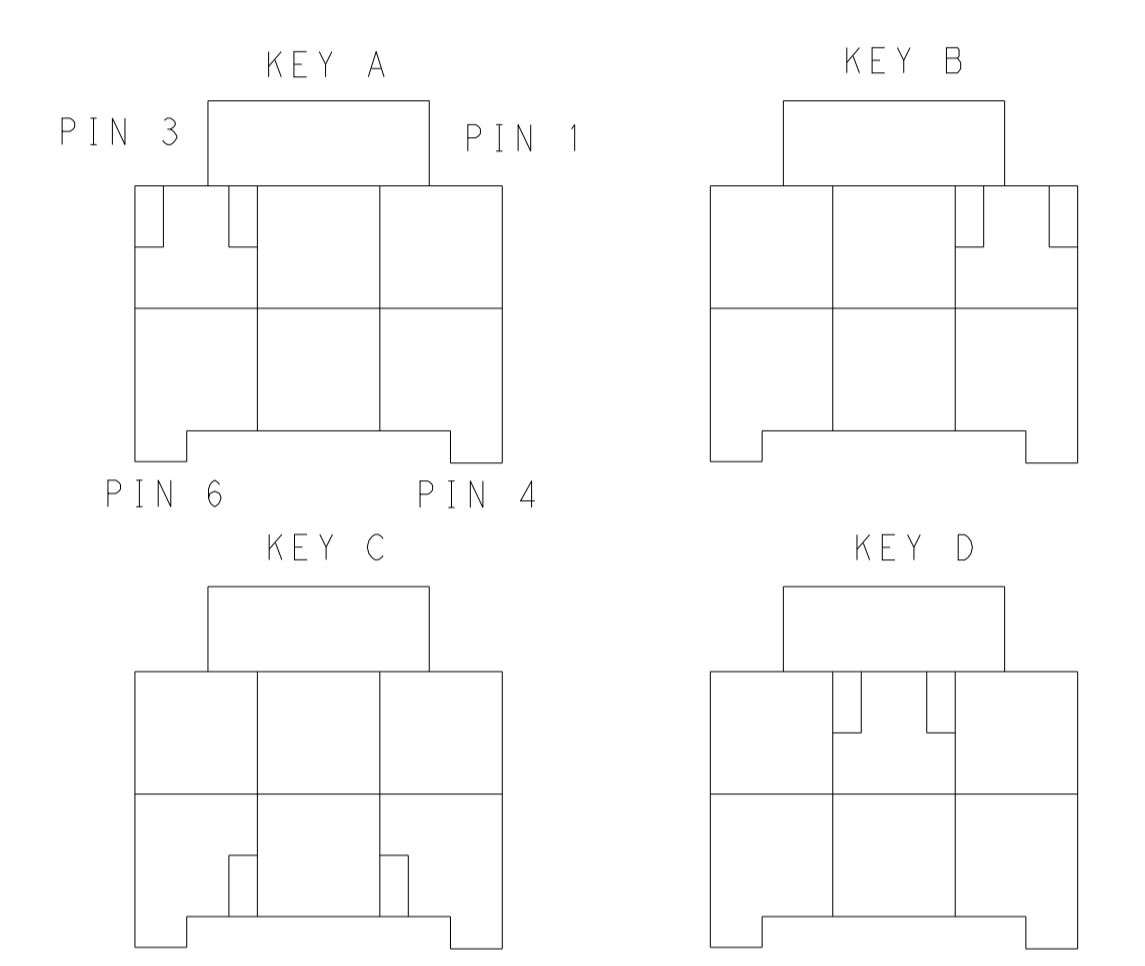

KEYING FOR 2*3 POS.

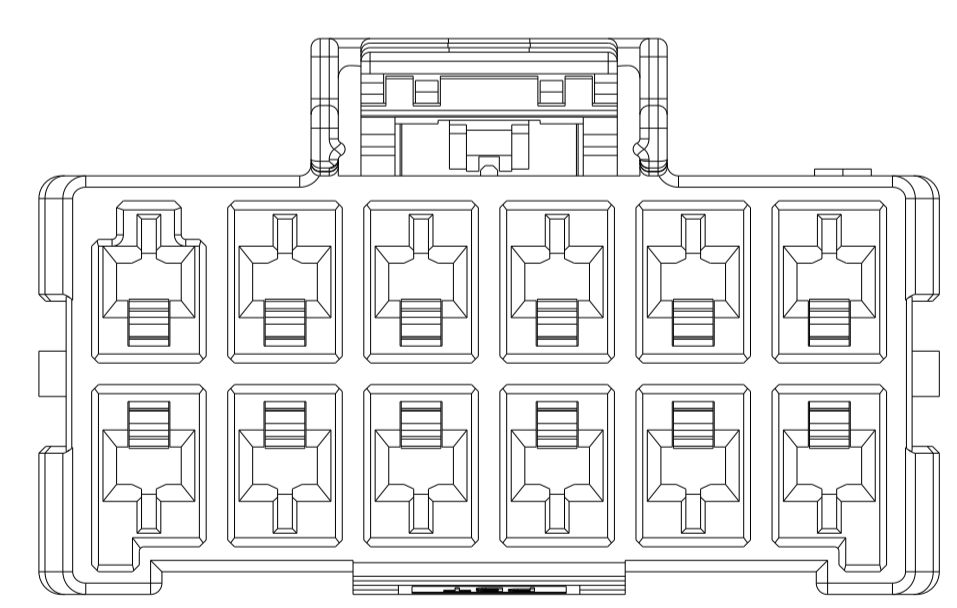
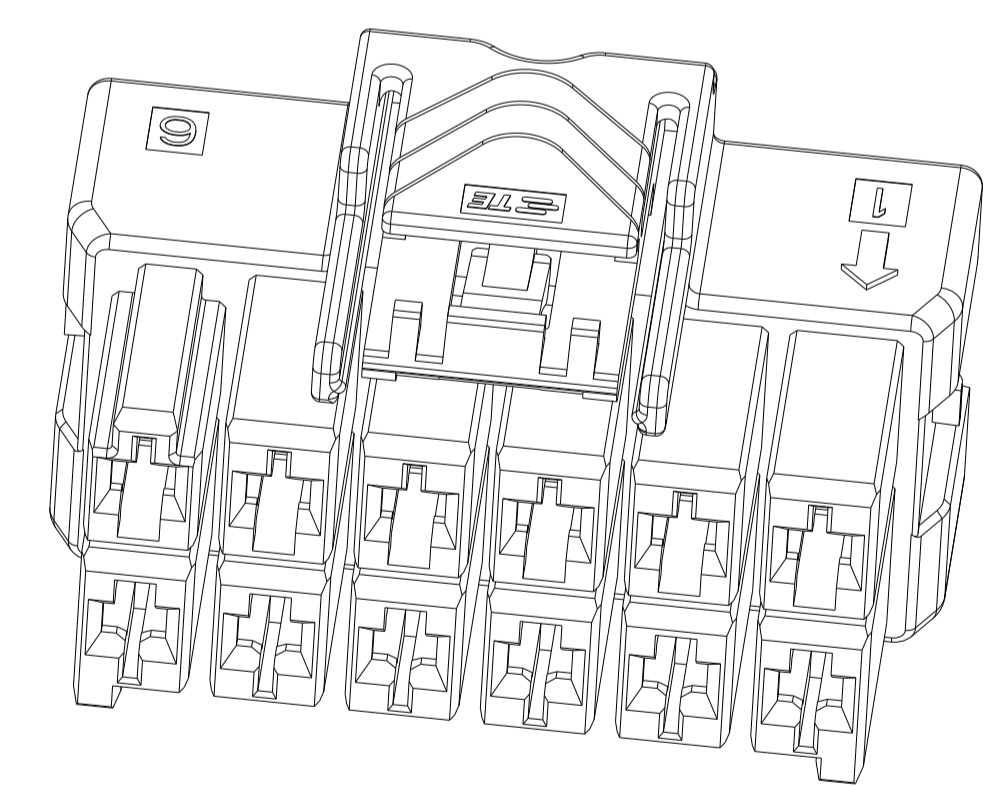

2*6 POSITIONS

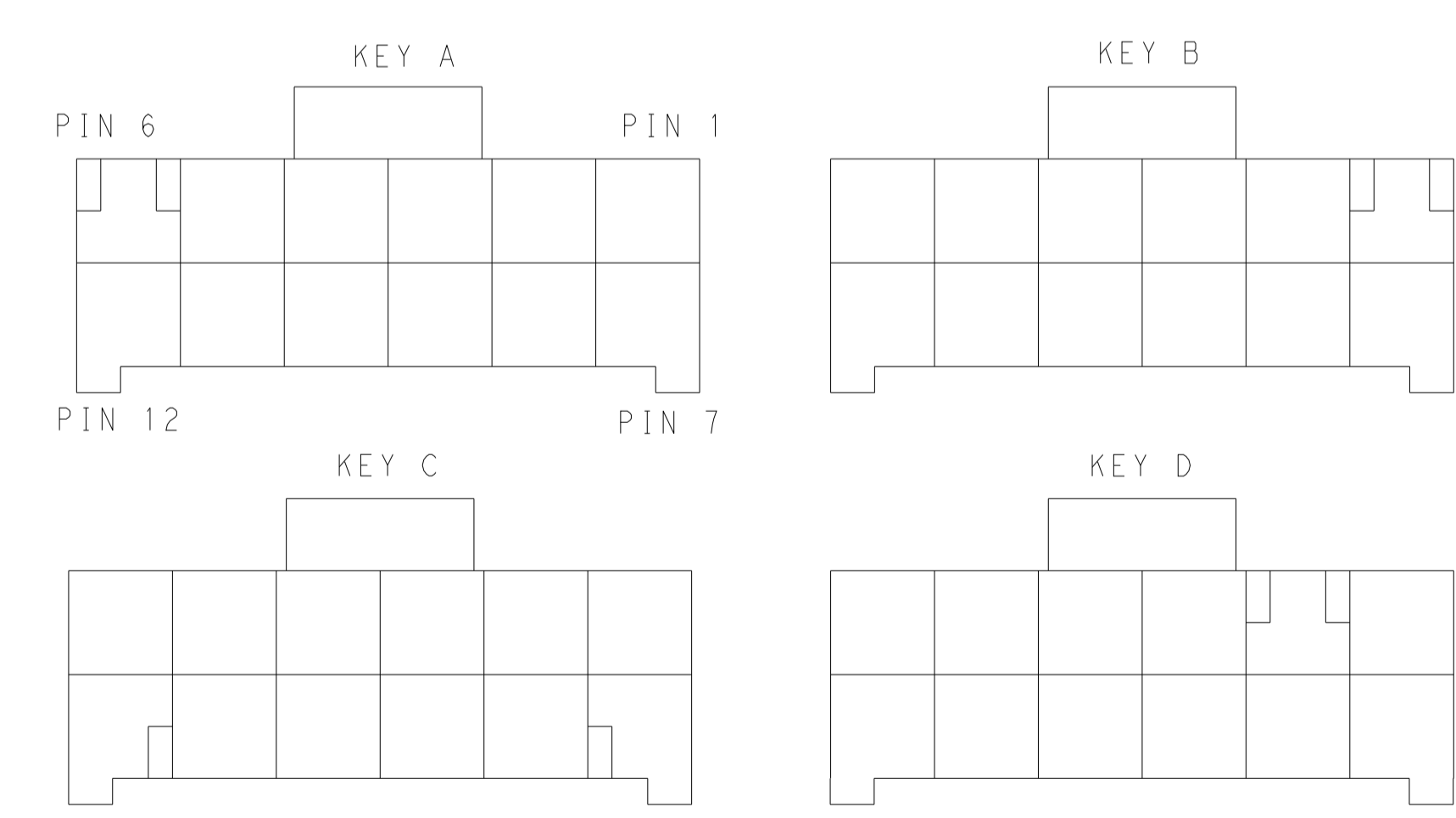

KEYING FOR 2*6 POS.

POS.	MATERIAL	COLOR	KEY	P/N
2*6	LEVEL A	DARK GREY	KEY A	5-2232266-4
		BROWN	KEY B	6-2232266-6
		GREEN	KEY C	7-2232266-6
		ORANGE	KEY D	8-2232266-6
2*5	LEVEL A	DARK GREY	KEY A	5-2232266-5
		BROWN	KEY B	6-2232266-5
		GREEN	KEY C	7-2232266-5
		ORANGE	KEY D	8-2232266-5

POS.	MATERIAL	COLOR	KEY	P/N
2*4	LEVEL A	DARK GREY	KEY A	5-2232266-4
		BROWN	KEY B	6-2232266-4
		GREEN	KEY C	7-2232266-4
		ORANGE	KEY D	8-2232266-4
2*3	LEVEL A	DARK GREY	KEY A	5-2232266-3
		BROWN	KEY B	6-2232266-3
		GREEN	KEY C	7-2232266-3
		ORANGE	KEY D	8-2232266-3
LEVEL B	BLACK	KEY A	1-2232266-1	

THIS DRAWING IS A CONTROLLED DOCUMENT.

DIMENSIONS:	TOLERANCES UNLESS OTHERWISE SPECIFIED:	OWN: TOMMY_WU 26MAR2013	CHK: TOMMY_WU 26MAR2013	TE Connectivity PLUG HOUSING, DOUBLE ROW POWER TRIPLE LOCK
mm	0 PLC ±0.15 1 PLC ±0.35 2 PLC ±0.25 3 PLC ±0.15 4 PLC ±0.15	CHK: HAPYE_WU 26MAR2013	APVD: YUHONG_MAO 26MAR2013	
		PRODUCT SPEC: 108-106118 APPLICATION SPEC: 114-106118		
MATERIAL:	FINISH:	WEIGHT:	Customer Drawing	

SIZE: A1 CAGE CODE: 00779 DRAWING NO: 2232266 RESTRICTED TO: 2 OF 2 SHEET REV D