

REVISIONS

P	LTR	DESCRIPTION	DATE	DWN	APVD
	A	NEW DRAWING	05JUL2022	LG	AP

NOTES:

1. PCB WITH A COPPER THICKNESS OF TWO OUNCES SHOULD BE USED.
2. FOR FURTHER INFORMATION SEE DATA SHEET FOR 3504 SERIES ALUMINUM NITRIDE THIN FILM POWER RESISTORS.

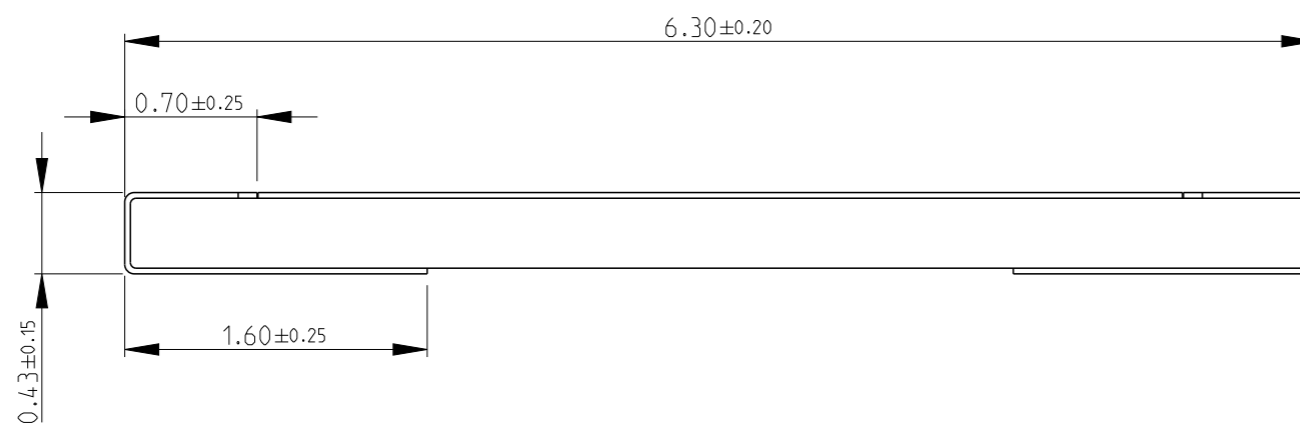
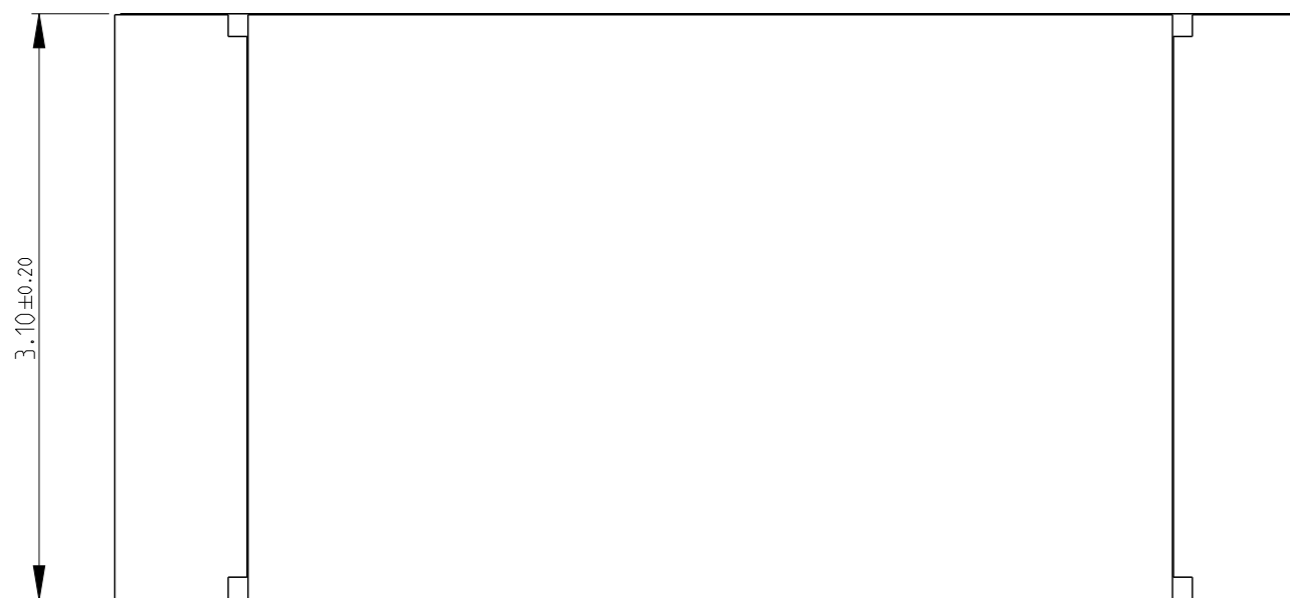

RoHS Compliant

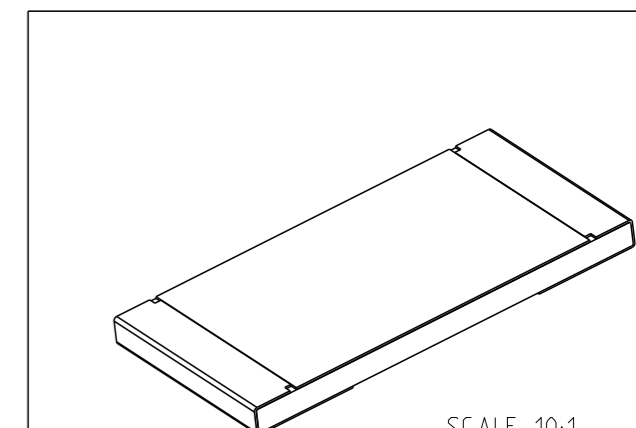

SCALE 10:1

RECOMMENDED LAND PATTERN

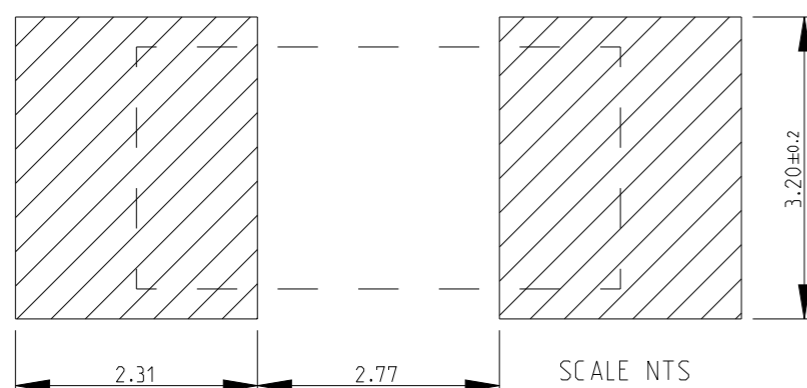

THIS DRAWING IS A CONTROLLED DOCUMENT.

DIMENSIONS:  
mm

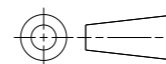

TOLERANCES UNLESS OTHERWISE SPECIFIED:

0 PLC	±0.5
1 PLC	±0.2
2 PLC	±0.1
3 PLC	±
4 PLC	±
ANGLES	±5°

MATERIAL  
-

FINISH  
-

DWN 05JUL2022

LALITH G

CHK 05JUL2022

ALLAN. P

APVD 05JUL2022

ALLAN. P

PRODUCT SPEC

-

APPLICATION SPEC

-

WEIGHT

-

NAME  
ALUMINIUM NITRIDE THIN FILM POWER RESISTOR TYPE 3504 SERIES



TE Connectivity

SIZE CAGE CODE DRAWING NO RESTRICTED TO

A3 00779 C=2176532 -

CUSTOMER DRAWING SCALE 25:1 SHEET 1 OF 3 REV A

REVISIONS

P	LTR	DESCRIPTION	DATE	DWN	APVD
	-	SEE SHEET 1	-	-	-

SCHEDULE			
TCPN	CATALOGUE NUMBER	PART DESCRIPTION	PART STATUS
2176532-1	3504G3A51R1FTE	3504G 3A 51R1 1% 4K RL	PRODUCTION
2176532-2	3504G3A52R3FTE	3504G 3A 52R3 1% 4K RL	PRODUCTION
2176532-3	3504G3A53R6FTE	3504G 3A 53R6 1% 4K RL	PRODUCTION
2176532-4	3504G3A54R9FTE	3504G 3A 54R9 1% 4K RL	PRODUCTION
2176532-5	3504G3A56R2FTE	3504G 3A 56R2 1% 4K RL	PRODUCTION
2176532-6	3504G3A57R6FTE	3504G 3A 57R6 1% 4K RL	PRODUCTION
2176532-7	3504G3A59RFTE	3504G 3A 59R 1% 4K RL	PRODUCTION
2176532-8	3504G3A60R4FTE	3504G 3A 60R4 1% 4K RL	PRODUCTION
2176532-9	3504G3A61R9FTE	3504G 3A 61R9 1% 4K RL	PRODUCTION
1-2176532-0	3504G3A63R4FTE	3504G 3A 63R4 1% 4K RL	PRODUCTION
1-2176532-1	3504G3A64R9FTE	3504G 3A 64R9 1% 4K RL	PRODUCTION
1-2176532-2	3504G3A66R5FTE	3504G 3A 66R5 1% 4K RL	PRODUCTION
1-2176532-3	3504G3A68R1FTE	3504G 3A 68R1 1% 4K RL	PRODUCTION
1-2176532-4	3504G3A69R8FTE	3504G 3A 69R8 1% 4K RL	PRODUCTION
1-2176532-5	3504G3A71R5FTE	3504G 3A 71R5 1% 4K RL	PRODUCTION
1-2176532-6	3504G3A73R2FTE	3504G 3A 73R2 1% 4K RL	PRODUCTION
1-2176532-7	3504G3A75RFTE	3504G 3A 75R 1% 4K RL	PRODUCTION
1-2176532-8	3504G3A76R8FTE	3504G 3A 76R8 1% 4K RL	PRODUCTION
1-2176532-9	3504G3A78R7FTE	3504G 3A 78R7 1% 4K RL	PRODUCTION
2-2176532-0	3504G3A80R6FTE	3504G 3A 80R6 1% 4K RL	PRODUCTION
2-2176532-1	3504G3A82R5FTE	3504G 3A 82R5 1% 4K RL	PRODUCTION
2-2176532-2	3504G3A84R5FTE	3504G 3A 84R5 1% 4K RL	PRODUCTION
2-2176532-3	3504G3A86R6FTE	3504G 3A 86R6 1% 4K RL	PRODUCTION
2-2176532-4	3504G3A88R7FTE	3504G 3A 88R7 1% 4K RL	PRODUCTION
2-2176532-5	3504G3A90R9FTE	3504G 3A 90R9 1% 4K RL	PRODUCTION
2-2176532-6	3504G3A93R1FTE	3504G 3A 93R1 1% 4K RL	PRODUCTION
2-2176532-7	3504G3A95R3FTE	3504G 3A 95R3 1% 4K RL	PRODUCTION
2-2176532-8	3504G3A97R6FTE	3504G 3A 97R6 1% 4K RL	PRODUCTION
2-2176532-9	3504G3A100RFTE	3504G 3A 100R 1% 4K RL	PRODUCTION
3-2176532-0	3504G3A102RFTE	3504G 3A 102R 1% 4K RL	PRODUCTION

SCHEDULE			
TCPN	CATALOGUE NUMBER	PART DESCRIPTION	PART STATUS
3-2176532-1	3504G3A105RFTE	3504G 3A 105R 1% 4K RL	PRODUCTION
3-2176532-2	3504G3A107RFTE	3504G 3A 107R 1% 4K RL	PRODUCTION
3-2176532-3	3504G3A110RFTE	3504G 3A 110R 1% 4K RL	PRODUCTION
3-2176532-4	3504G3A113RFTE	3504G 3A 113R 1% 4K RL	PRODUCTION
3-2176532-5	3504G3A115RFTE	3504G 3A 115R 1% 4K RL	PRODUCTION
3-2176532-6	3504G3A118RFTE	3504G 3A 118R 1% 4K RL	PRODUCTION
3-2176532-7	3504G3A121RFTE	3504G 3A 121R 1% 4K RL	PRODUCTION
3-2176532-8	3504G3A124RFTE	3504G 3A 124R 1% 4K RL	PRODUCTION
3-2176532-9	3504G3A127RFTE	3504G 3A 127R 1% 4K RL	PRODUCTION
4-2176532-0	3504G3A130RFTE	3504G 3A 130R 1% 4K RL	PRODUCTION
4-2176532-1	3504G3A133RFTE	3504G 3A 133R 1% 4K RL	PRODUCTION
4-2176532-2	3504G3A137RFTE	3504G 3A 137R 1% 4K RL	PRODUCTION
4-2176532-3	3504G3A140RFTE	3504G 3A 140R 1% 4K RL	PRODUCTION
4-2176532-4	3504G3A143RFTE	3504G 3A 143R 1% 4K RL	PRODUCTION
4-2176532-5	3504G3A147RFTE	3504G 3A 147R 1% 4K RL	PRODUCTION
4-2176532-6	3504G3A150RFTE	3504G 3A 150R 1% 4K RL	PRODUCTION
4-2176532-7	3504G3A154RFTE	3504G 3A 154R 1% 4K RL	PRODUCTION
4-2176532-8	3504G3A158RFTE	3504G 3A 158R 1% 4K RL	PRODUCTION
4-2176532-9	3504G3A162RFTE	3504G 3A 162R 1% 4K RL	PRODUCTION
5-2176532-0	3504G3A165RFTE	3504G 3A 165R 1% 4K RL	PRODUCTION
5-2176532-1	3504G3A169RFTE	3504G 3A 169R 1% 4K RL	PRODUCTION
5-2176532-2	3504G3A174RFTE	3504G 3A 174R 1% 4K RL	PRODUCTION
5-2176532-3	3504G3A178RFTE	3504G 3A 178R 1% 4K RL	PRODUCTION
5-2176532-4	3504G3A182RFTE	3504G 3A 182R 1% 4K RL	PRODUCTION
5-2176532-5	3504G3A187RFTE	3504G 3A 187R 1% 4K RL	PRODUCTION
5-2176532-6	3504G3A191RFTE	3504G 3A 191R 1% 4K RL	PRODUCTION
5-2176532-7	3504G3A196RFTE	3504G 3A 196R 1% 4K RL	PRODUCTION
5-2176532-8	3504G3A200RFTE	3504G 3A 200R 1% 4K RL	PRODUCTION
5-2176532-9	3504G3A205RFTE	3504G 3A 205R 1% 4K RL	PRODUCTION
6-2176532-0	3504G3A210RFTE	3504G 3A 210R 1% 4K RL	PRODUCTION

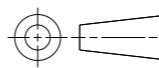
THIS DRAWING IS A CONTROLLED DOCUMENT.		DWN LALITH G	05JUL2022	 TE Connectivity NAME ALUMINIUM NITRIDE THIN FILM POWER RESISTOR TYPE 3504 SERIES	
DIMENSIONS: mm		CHK ALLAN. P	05JUL2022		
		APVD ALLAN. P	05JUL2022		
TOLERANCES UNLESS OTHERWISE SPECIFIED:		PRODUCT SPEC		SIZE	
0 PLC	±0.5	APPLICATION SPEC		CAGE CODE	
1 PLC	±0.2	-		DRAWING NO	
2 PLC	±0.1	-		RESTRICTED TO	
3 PLC	±	-		-	
4 PLC	±	-		-	
ANGLES	±°	WEIGHT		-	
MATERIAL	FINISH	CUSTOMER DRAWING		SCALE 25:1	
-	-	-		SHEET 2 OF 3	
-	-	-		REV A	

REVISIONS

P	LTR	DESCRIPTION	DATE	DWN	APVD
	-	SEE SHEET 1	-	-	-

SCHEDULE

TCPN	CATALOGUE NUMBER	PART DESCRIPTION	PART STATUS
6-2176532-1	3504G3A215RFTE	3504G 3A 215R 1% 4K RL	PRODUCTION
6-2176532-2	3504G3A221RFTE	3504G 3A 221R 1% 4K RL	PRODUCTION
6-2176532-3	3504G3A226RFTE	3504G 3A 226R 1% 4K RL	PRODUCTION
6-2176532-4	3504G3A232RFTE	3504G 3A 232R 1% 4K RL	PRODUCTION
6-2176532-5	3504G3A237RFTE	3504G 3A 237R 1% 4K RL	PRODUCTION
6-2176532-6	3504G3A243RFTE	3504G 3A 243R 1% 4K RL	PRODUCTION
6-2176532-7	3504G3A249RFTE	3504G 3A 249R 1% 4K RL	PRODUCTION
6-2176532-8	3504G3A255RFTE	3504G 3A 255R 1% 4K RL	PRODUCTION
6-2176532-9	3504G3A261RFTE	3504G 3A 261R 1% 4K RL	PRODUCTION
7-2176532-0	3504G3A267RFTE	3504G 3A 267R 1% 4K RL	PRODUCTION
7-2176532-1	3504G3A274RFTE	3504G 3A 274R 1% 4K RL	PRODUCTION
7-2176532-2	3504G3A280RFTE	3504G 3A 280R 1% 4K RL	PRODUCTION
7-2176532-3	3504G3A287RFTE	3504G 3A 287R 1% 4K RL	PRODUCTION
7-2176532-4	3504G3A294RFTE	3504G 3A 294R 1% 4K RL	PRODUCTION
7-2176532-5	3504G3A301RFTE	3504G 3A 301R 1% 4K RL	PRODUCTION
7-2176532-6	3504G3A309RFTE	3504G 3A 309R 1% 4K RL	PRODUCTION
7-2176532-7	3504G3A316RFTE	3504G 3A 316R 1% 4K RL	PRODUCTION
7-2176532-8	3504G3A324RFTE	3504G 3A 324R 1% 4K RL	PRODUCTION
7-2176532-9	3504G3A332RFTE	3504G 3A 332R 1% 4K RL	PRODUCTION
8-2176532-0	3504G3A340RFTE	3504G 3A 340R 1% 4K RL	PRODUCTION
8-2176532-1	3504G3A348RFTE	3504G 3A 348R 1% 4K RL	PRODUCTION
8-2176532-2	3504G3A357RFTE	3504G 3A 357R 1% 4K RL	PRODUCTION
8-2176532-3	3504G3A365RFTE	3504G 3A 365R 1% 4K RL	PRODUCTION
8-2176532-4	3504G3A374RFTE	3504G 3A 374R 1% 4K RL	PRODUCTION
8-2176532-5	3504G3A383RFTE	3504G 3A 383R 1% 4K RL	PRODUCTION
8-2176532-6	3504G3A392RFTE	3504G 3A 392R 1% 4K RL	PRODUCTION
8-2176532-7	3504G3A402RFTE	3504G 3A 402R 1% 4K RL	PRODUCTION
8-2176532-8	3504G3A412RFTE	3504G 3A 412R 1% 4K RL	PRODUCTION
8-2176532-9	3504G3A422RFTE	3504G 3A 422R 1% 4K RL	PRODUCTION
9-2176532-0	3504G3A432RFTE	3504G 3A 432R 1% 4K RL	PRODUCTION
9-2176532-1	3504G3A442RFTE	3504G 3A 442R 1% 4K RL	PRODUCTION
9-2176532-2	3504G3A453RFTE	3504G 3A 453R 1% 4K RL	PRODUCTION
9-2176532-3	3504G3A464RFTE	3504G 3A 464R 1% 4K RL	PRODUCTION
9-2176532-4	3504G3A475RFTE	3504G 3A 475R 1% 4K RL	PRODUCTION
9-2176532-5	3504G3A487RFTE	3504G 3A 487R 1% 4K RL	PRODUCTION
9-2176532-6	3504G3A499RFTE	3504G 3A 499R 1% 4K RL	PRODUCTION
9-2176532-7	3504G3A511RFTE	3504G 3A 511R 1% 4K RL	PRODUCTION
9-2176532-8	3504G3A523RFTE	3504G 3A 523R 1% 4K RL	PRODUCTION
9-2176532-9	3504G3A536RFTE	3504G 3A 536R 1% 4K RL	PRODUCTION

THIS DRAWING IS A CONTROLLED DOCUMENT.

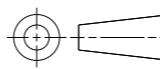
DIMENSIONS: mm	
	
MATERIAL	-
	-

TOLERANCES UNLESS OTHERWISE SPECIFIED:	
0 PLC	±0.5
1 PLC	±0.2
2 PLC	±0.1
3 PLC	±
4 PLC	±
ANGLES	±5°
FINISH	-
	-

DWN	LALITH G	05JUL2022
CHK	ALLAN. P	05JUL2022
APVD	ALLAN. P	05JUL2022
PRODUCT SPEC	-	
APPLICATION SPEC	-	
WEIGHT	-	
CUSTOMER DRAWING		

		TE Connectivity	
		NAME ALUMINIUM NITRIDE THIN FILM POWER RESISTOR TYPE 3504 SERIES	
SIZE	CAGE CODE	DRAWING NO	RESTRICTED TO
A3	00779	©=2176532	-
SCALE		SHEET	REV
25:1		3 OF 3	A