

THIS DRAWING IS UNPUBLISHED. RELEASED FOR PUBLICATION  
 © COPYRIGHT - By - ALL RIGHTS RESERVED.

REVISIONS					
P	LTR	DESCRIPTION	DATE	DWN	APVD
J7		ECO-19-018009 (SEE PAGE NO 3)	18SEP2019	RR	SH

NOTES:

1. TOLERANCES UNLESS OTHERWISE SPECIFIED: ±0.15
2. FOR APPLICATION INFORMATION SEE AMP SPEC. 114-19019.
3. FOR PERFORMANCE REQUIREMENTS SEE AMP SPEC. 108-19064

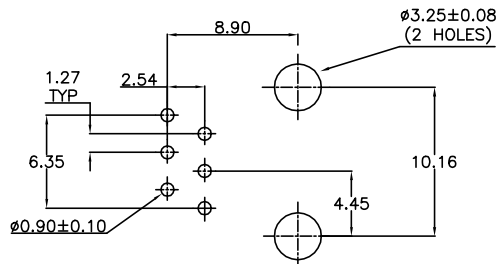
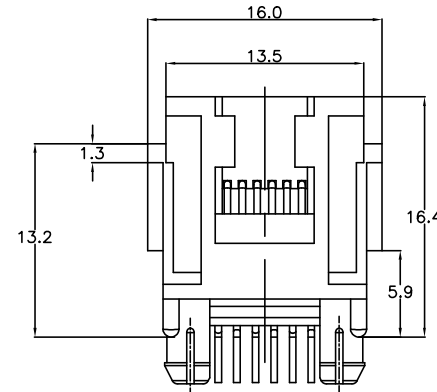
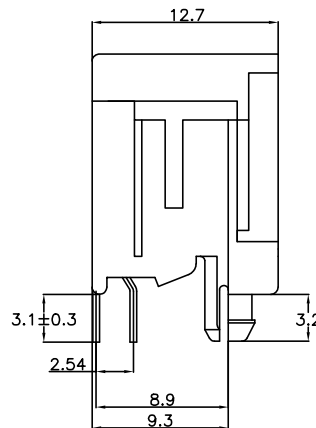
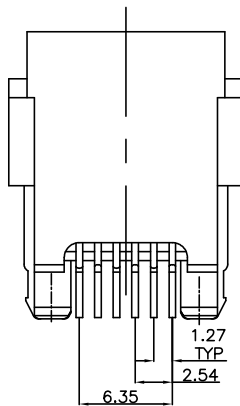
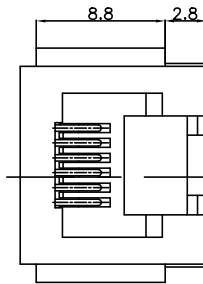

PRINTED CIRCUIT BOARD LAYOUT

[VIEW SHOWN IS CIRCUIT (NONCOMPONENT) SIDE OF BOARD.]  
 TOLERANCES UNLESS OTHERWISE SPECIFIED: ±0.05  
 PRINTED CIRCUIT BOARD THICKNESS: 1.6 mm NOMINAL.

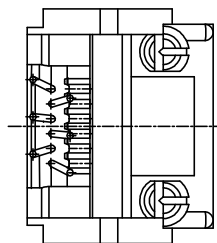

800 PCS. ON A 60cm. DIA. REEL	6 POSITIONS/ 6 CONTACTS.	IN CONTACT AREA: 1.2µm MIN. SEL. GOLD OVER 1.2µm MIN. NICKEL	HOUSING: PBT,UL 94V-HB COLOR: BLACK	216548-1
PACKAGING	REMARKS	FINISH	MATERIAL	PART NUMBER
		SOLDER TINES: 2.0µm MIN. TIN OVER 1.2µm MIN. NICKEL	CONTACTS: PHOSPHOR BRONZE	

THIS DRAWING IS A CONTROLLED DOCUMENT.		DWN J.V. LIEMPT	22JAN92	TE Connectivity																									
DIMENSIONS: mm		CHK C. STERKEN	APVD L.V. SOEST	NAME																									
TOLERANCES UNLESS OTHERWISE SPECIFIED:		PRODUCT SPEC		MODULAR JACK, 6 POS. TOP ENTRY, SMALL SIZE WITH PANEL STOPS, FOR PCB																									
<table border="1"> <tr><td>0</td><td>PLC</td><td>±</td><td>-</td></tr> <tr><td>1</td><td>PLC</td><td>±</td><td>-</td></tr> <tr><td>2</td><td>PLC</td><td>±</td><td>-</td></tr> <tr><td>3</td><td>PLC</td><td>±</td><td>-</td></tr> <tr><td>4</td><td>PLC</td><td>±</td><td>-</td></tr> <tr><td></td><td>ANGLES</td><td>±</td><td>-</td></tr> </table>		0	PLC	±	-	1	PLC	±	-	2	PLC	±	-	3	PLC	±	-	4	PLC	±	-		ANGLES	±	-	APPLICATION SPEC		RESTRICTED TO	
0	PLC	±	-																										
1	PLC	±	-																										
2	PLC	±	-																										
3	PLC	±	-																										
4	PLC	±	-																										
	ANGLES	±	-																										
MATERIAL SEE TABLE		WEIGHT -		SIZE A2																									
FINISH SEE TABLE		CAGE CODE 00779		DRAWING NO 216548																									
		CUSTOMER DRAWING		SCALE -																									
				SHEET 1 of 3																									
				REV J7																									

THIS DRAWING IS UNPUBLISHED. RELEASED FOR PUBLICATION  
 © COPYRIGHT - By - ALL RIGHTS RESERVED.

REVISIONS					
P	LT/R	DESCRIPTION	DATE	DNW	APVD
-	-	SEE SHEET 1	-	-	-

NOTES:

1. TOLERANCES UNLESS OTHERWISE SPECIFIED:  $\pm 0.15$
2. FOR APPLICATION INFORMATION SEE AMP SPEC. 114-19019.
3. FOR PERFORMANCE REQUIREMENTS SEE AMP SPEC. 108-19064

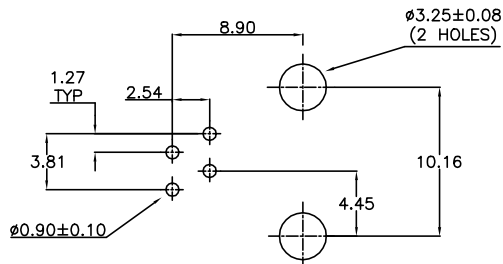
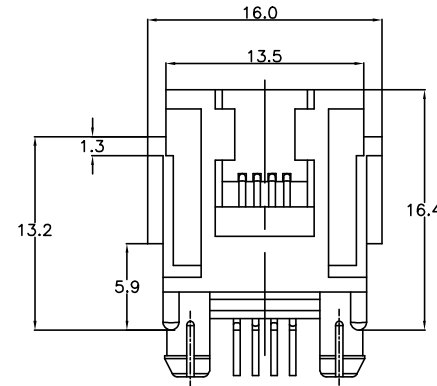
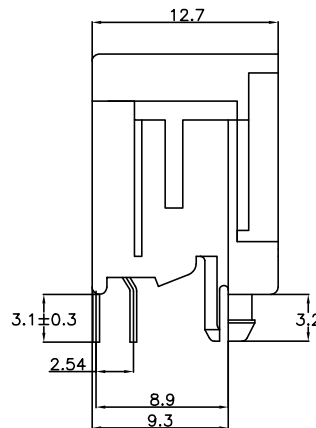
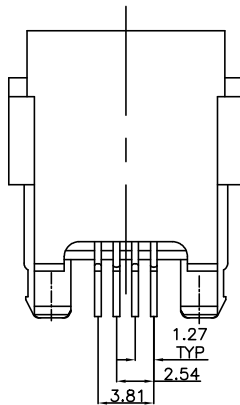
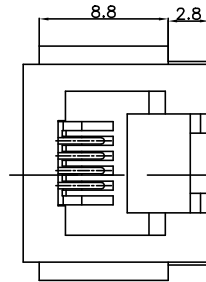

PRINTED CIRCUIT BOARD LAYOUT

[VIEW SHOWN IS CIRCUIT (NONCOMPONENT) SIDE OF BOARD.]  
 TOLERANCES UNLESS OTHERWISE SPECIFIED:  $\pm 0.05$   
 PRINTED CIRCUIT BOARD THICKNESS: 1.6 mm NOMINAL.

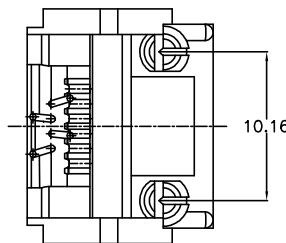

800 PCS. ON A 60cm. DIA. REEL	6 POSITIONS/ 4 CONTACTS.	IN CONTACT AREA: 1.2 $\mu$ m MIN. SEL. GOLD OVER 1.2 $\mu$ m MIN. NICKEL	HOUSING: PBT,UL 94V-HB COLOR: BLACK	216548-2
PACKAGING	REMARKS	FINISH	MATERIAL	PART NUMBER
		SOLDER TINES: 2.0 $\mu$ m MIN. TIN OVER 1.2 $\mu$ m MIN. NICKEL	CONTACTS: PHOSPHOR BRONZE	

THIS DRAWING IS A CONTROLLED DOCUMENT.		DNW J.V. LIEMPT 22JAN92	TE Connectivity																									
DIMENSIONS: mm		CHK C. STERKEN	NAME																									
TOLERANCES UNLESS OTHERWISE SPECIFIED:		APVD L.V. SOEST	MODULAR JACK, 6 POS. TOP ENTRY, SMALL SIZE WITH PANEL STOPS, FOR PCB																									
<table border="1"> <tr><td>0</td><td>PLC</td><td>±</td><td>-</td></tr> <tr><td>1</td><td>PLC</td><td>±</td><td>-</td></tr> <tr><td>2</td><td>PLC</td><td>±</td><td>-</td></tr> <tr><td>3</td><td>PLC</td><td>±</td><td>-</td></tr> <tr><td>4</td><td>PLC</td><td>±</td><td>-</td></tr> <tr><td></td><td>ANGLES</td><td>±</td><td>-</td></tr> </table>		0	PLC	±	-	1	PLC	±	-	2	PLC	±	-	3	PLC	±	-	4	PLC	±	-		ANGLES	±	-	PRODUCT SPEC	SIZE	CAGE CODE
0	PLC	±	-																									
1	PLC	±	-																									
2	PLC	±	-																									
3	PLC	±	-																									
4	PLC	±	-																									
	ANGLES	±	-																									
MATERIAL SEE TABLE		APPLICATION SPEC	A2	00779																								
FINISH SEE TABLE		WEIGHT	DRAWING NO ©=216548																									
		CUSTOMER DRAWING	SCALE	SHEET 2 of 3																								
			REV	J7																								

THIS DRAWING IS UNPUBLISHED. RELEASED FOR PUBLICATION  
 © COPYRIGHT - By - ALL RIGHTS RESERVED.

REVISIONS					
P	LTR	DESCRIPTION	DATE	DWN	APVD
-	-	SEE SHEET 1	-	-	-

NOTES:

1. TOLERANCES UNLESS OTHERWISE SPECIFIED:  $\pm 0.15$
2. FOR APPLICATION INFORMATION SEE AMP SPEC. 114-19019.
3. FOR PERFORMANCE REQUIREMENTS SEE AMP SPEC. 108-19064

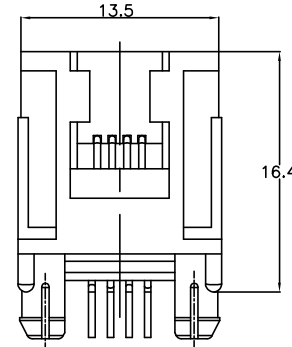
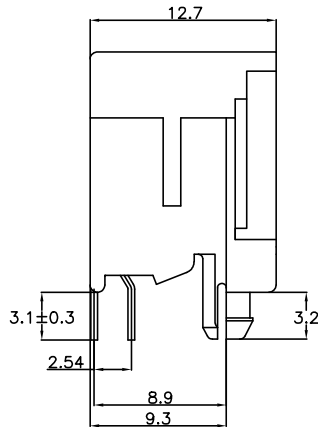
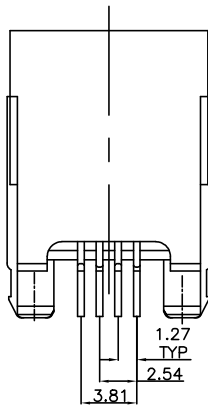

Ⓝ ONLY VIEW UPDATED

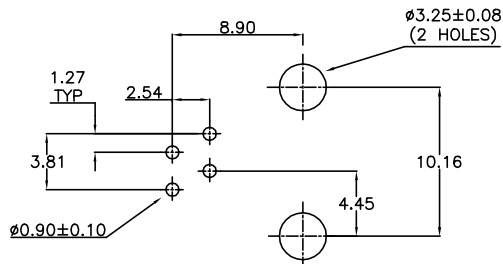

PRINTED CIRCUIT BOARD LAYOUT

[VIEW SHOWN IS CIRCUIT (NONCOMPONENT) SIDE OF BOARD.]  
 TOLERANCES UNLESS OTHERWISE SPECIFIED:  $\pm 0.05$   
 PRINTED CIRCUIT BOARD THICKNESS: 1.6 mm NOMINAL.

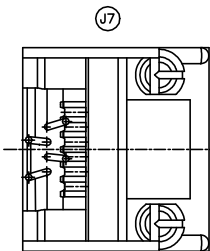

240 PCS. IN ONE TRAY	6 POSITIONS/ 4 CONTACTS.	IN CONTACT AREA: 1.2μm MIN. SEL. GOLD OVER 1.2μm MIN. NICKEL SOLDER TINES: 2.0μm MIN. TIN OVER 1.2μm MIN. NICKEL	HOUSING: PBT,UL 94V-HB COLOR: BLACK CONTACTS: PHOSPHOR BRONZE	1-216548-5
240 PCS. IN ONE TRAY	6 POSITIONS/ 4 CONTACTS.	IN CONTACT AREA: 1.2μm MIN. SEL. GOLD OVER 1.2μm MIN. NICKEL SOLDER TINES: 2.0μm MIN. TIN OVER 1.2μm MIN. NICKEL	HOUSING: PBT,UL 94V-V0 COLOR: GRAY CONTACTS: PHOSPHOR BRONZE	216548-6
800 PCS. ON A 60cm. DIA. REEL	6 POSITIONS/ 4 CONTACTS.	IN CONTACT AREA: 1.2μm MIN. SEL. GOLD OVER 1.2μm MIN. NICKEL SOLDER TINES: 2.0μm MIN. TIN OVER 1.2μm MIN. NICKEL	HOUSING: PBT,UL 94V-HB COLOR: BLACK CONTACTS: PHOSPHOR BRONZE	216548-5
PACKAGING	REMARKS	FINISH	MATERIAL	PART NUMBER

THIS DRAWING IS A CONTROLLED DOCUMENT.

DWN 22JAN92

CHK L.V.LIEMPT

CHK C.STERKEN

APVD L.V.SOEST

PRODUCT SPEC

APPLICATION SPEC

FINISH

WEIGHT

CUSTOMER DRAWING

TE Connectivity



MODULAR JACK, 6 POS. TOP ENTRY,  
 SMALL SIZE WITHOUT PANEL STOPS,  
 FOR PCB

SIZE A2 CAGE CODE 00779 DRAWING NO. C=216548

RESTRICTED TO

SCALE - SHEET 3 of 3 REV J7