

THIS DRAWING IS UNPUBLISHED. RELEASED FOR PUBLICATION
 © COPYRIGHT copyright.d8Te- ALL RIGHTS RESERVED.

REVISIONS				
P	LTR	DESCRIPTION	DATE	APVD
B		RELEASED PER ECR-21-100757	04MAR2021	SK DZ
B2		RELEASED PER ECR-21-121051	23NOV2021	SK DZ

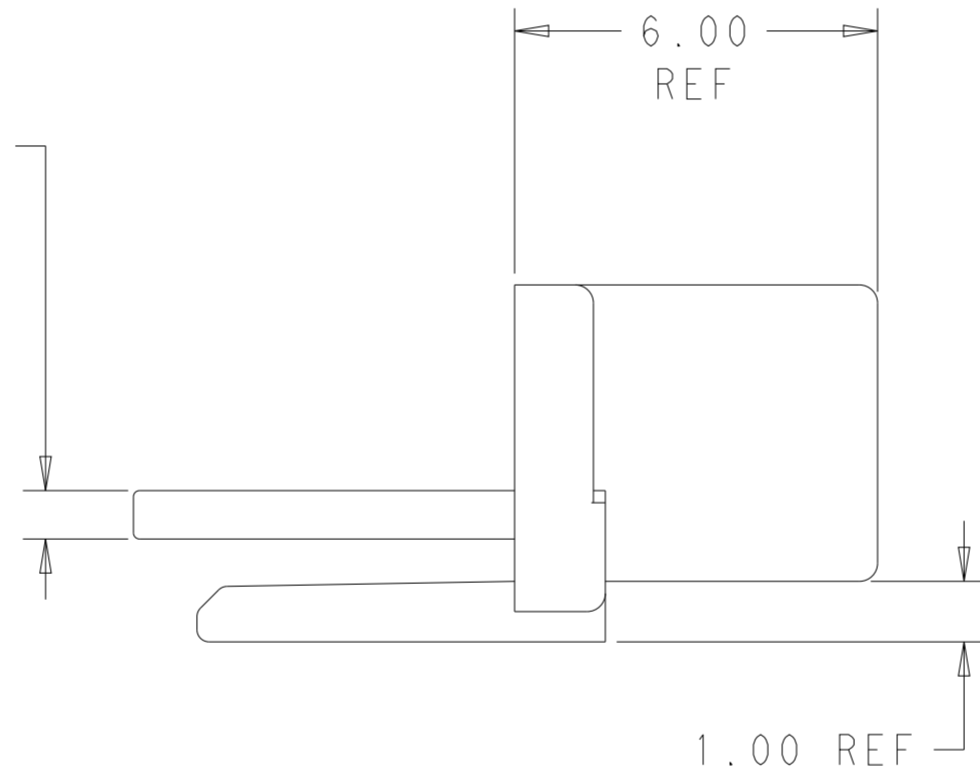
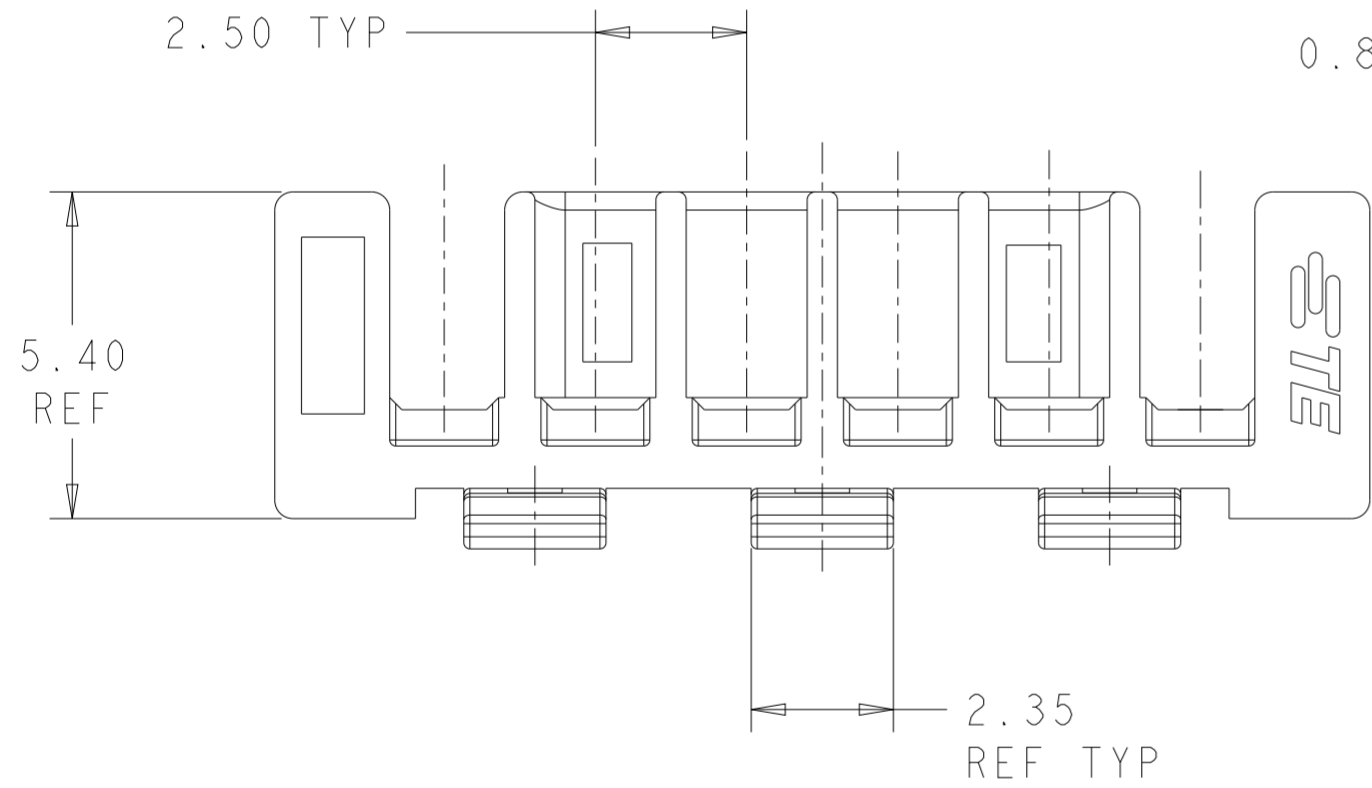
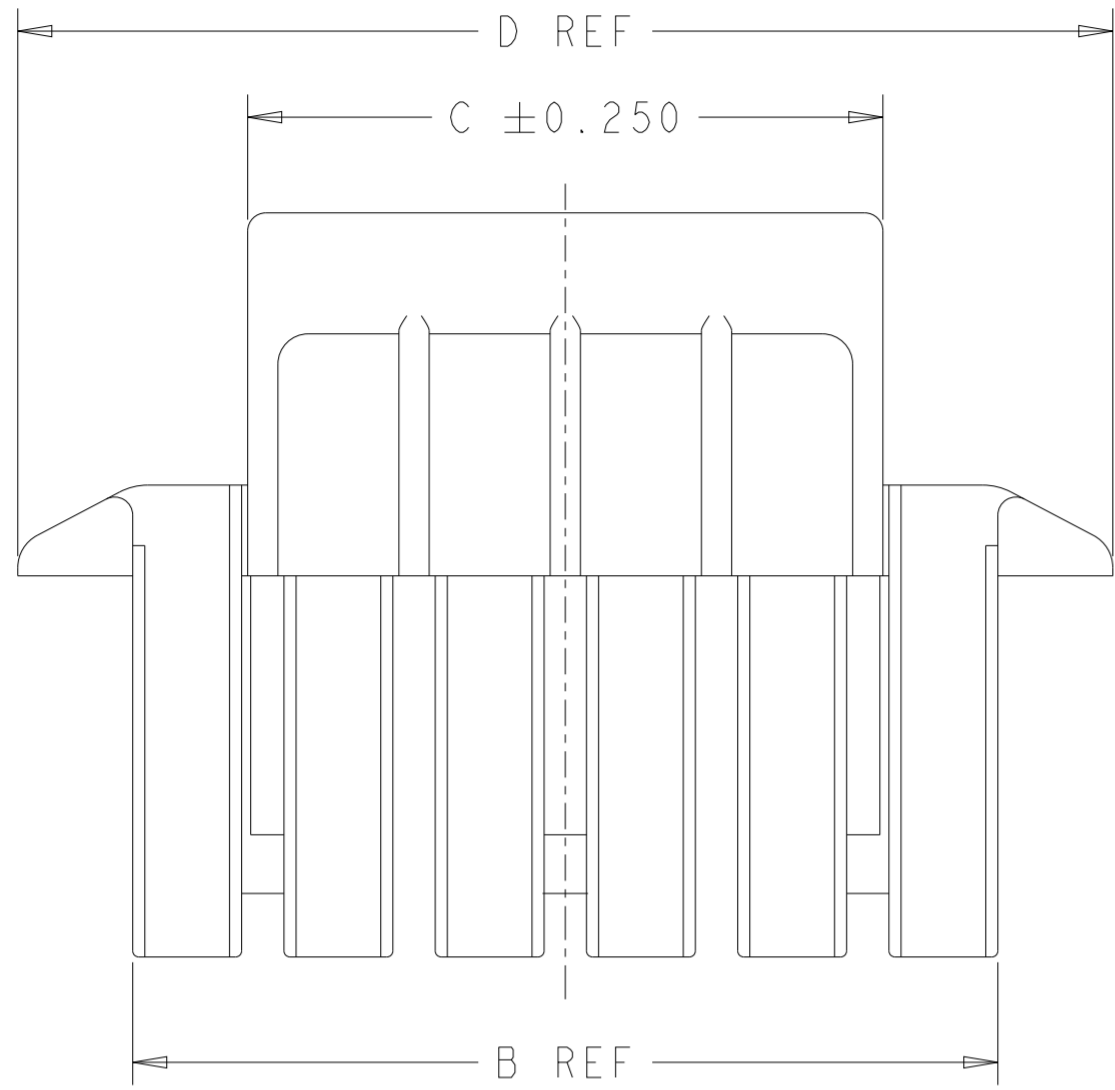

- 1 MATERIAL; HIGH PERFORMANCE RISIN, UL94-V0, GLASS FILLED, COLOR - BLACK
- 2 MATES WITH HOUSING 1969442-(X)

53.1	10.5	49.3	20	2-1969825-0
50.6	13	46.8	19	1-1969825-9
48.1	10.5	44.3	18	1-1969825-8
45.6	13	41.8	17	1-1969825-7
43.1	10.5	39.3	16	1-1969825-6
40.6	13	36.8	15	1-1969825-5
38.1	10.5	34.3	14	1-1969825-4
35.6	13	31.8	13	1-1969825-3
33.1	10.5	29.3	12	1-1969825-2
30.6	13	26.8	11	1-1969825-1
28.1	10.5	24.3	10	1-1969825-0
25.6	13	21.8	9	1969825-9
23.1	10.5	19.3	8	1969825-8
20.6	13	16.8	7	1969825-7
18.1	10.5	14.3	6	1969825-6
16.7	13	11.8	5	1969825-5
14.2	10.5	9.3	4	1969825-4
11.7	8	6.8	3	1969825-3
8.1	5.5	4.3	2	1969825-2
DIM D	DIM C	DIM B	POSITIONS	PART NO.

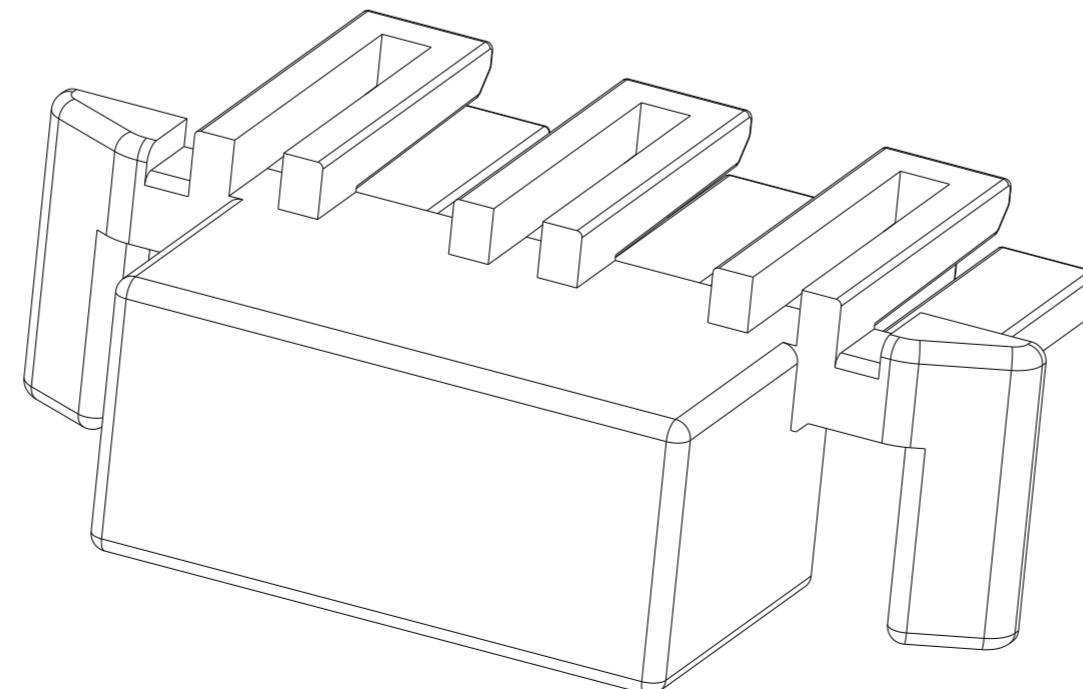
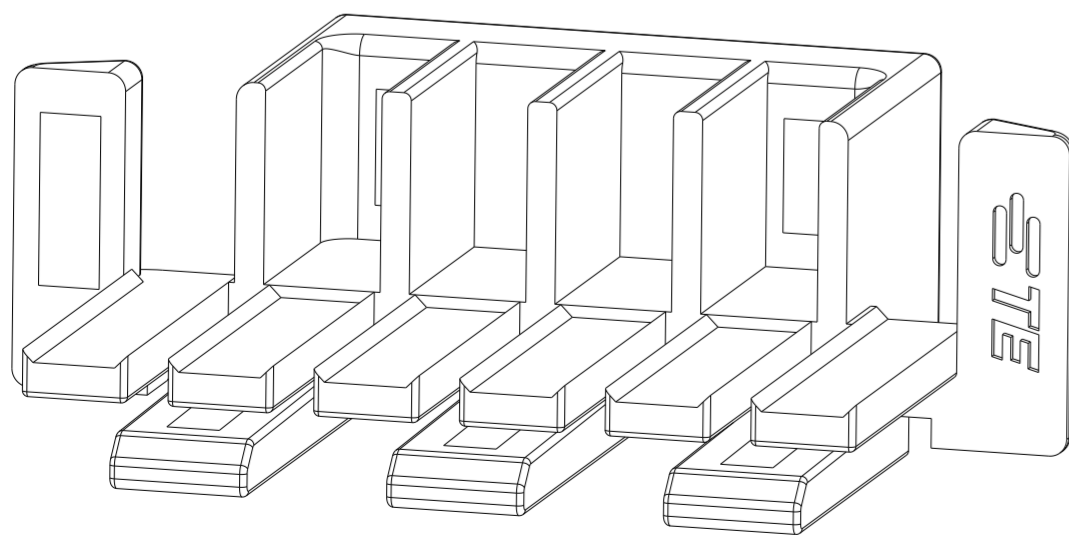

THIS DRAWING IS A CONTROLLED DOCUMENT.

DIMENSIONS:	TOLERANCES UNLESS OTHERWISE SPECIFIED:	DWN	20-Jan-16
mm	0 PLC ±	CHK	JR RUTH
	1 PLC ±	D	FAROLE
	2 PLC ±0.13	APVD	D. FAROLE
	3 PLC ±	PRODUCT SPEC	20JAN16
	4 PLC ±	APPLICATION SPEC	
	ANGLES ±	WEIGHT	
	FINISH ±	CUSTOMER DRAWING	

NAME: ECONOMY POWER 2.5 TPA RETAINER

SIZE: A2 CAGE CODE: - DRAWING NO: C-1969825 RESTRICTED TO: -

SCALE: N/A SHEET: 1 OF 2 REV: B2

THIS DRAWING IS UNPUBLISHED. RELEASED FOR PUBLICATION
© COPYRIGHT copyright.d8te- ALL RIGHTS RESERVED.

REVISIONS					
P	LTR	DESCRIPTION	DATE	DWN	APVD
-	-	SEE SHEET 1	-	-	-

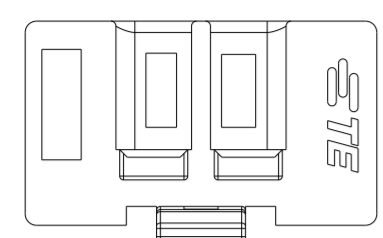

1969825-2

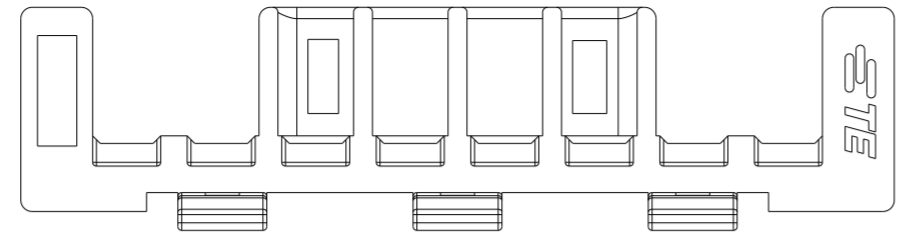

1969825-8

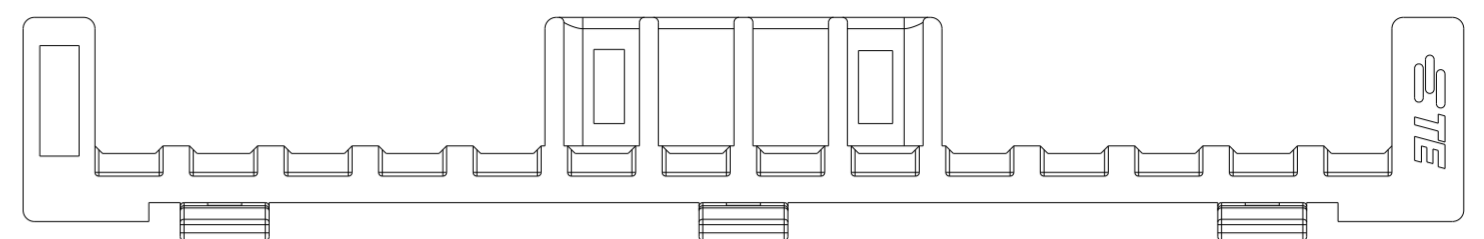

1-1969825-4

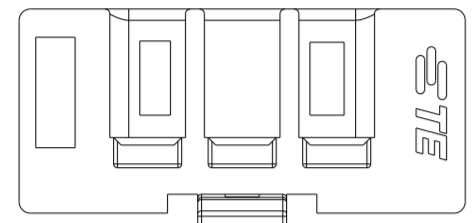

1969825-3

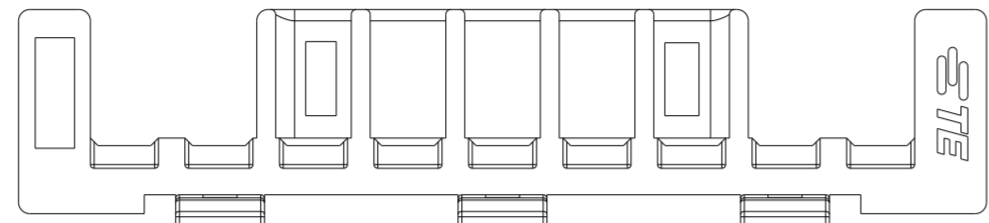

1969825-9

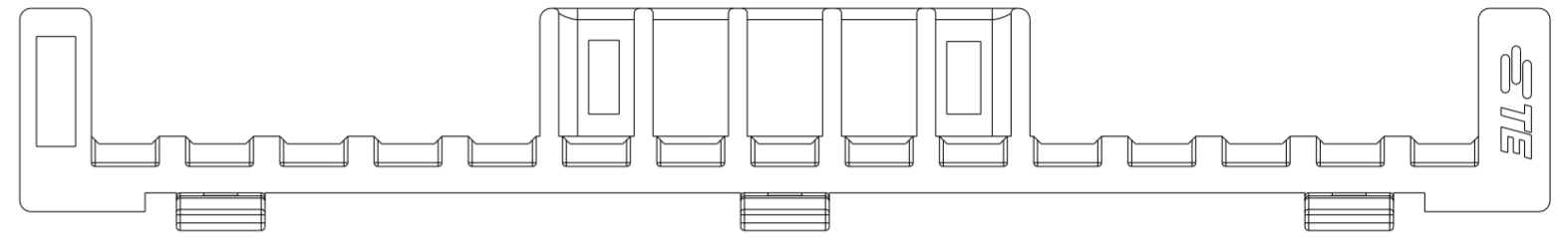

1-1969825-5

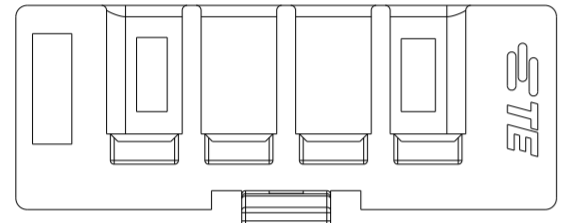

1969825-4

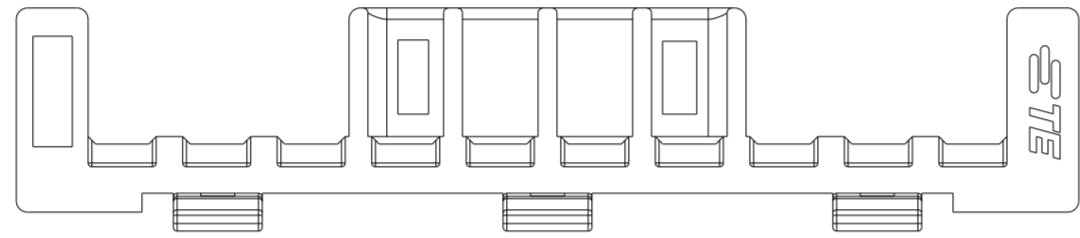

1-1969825-0

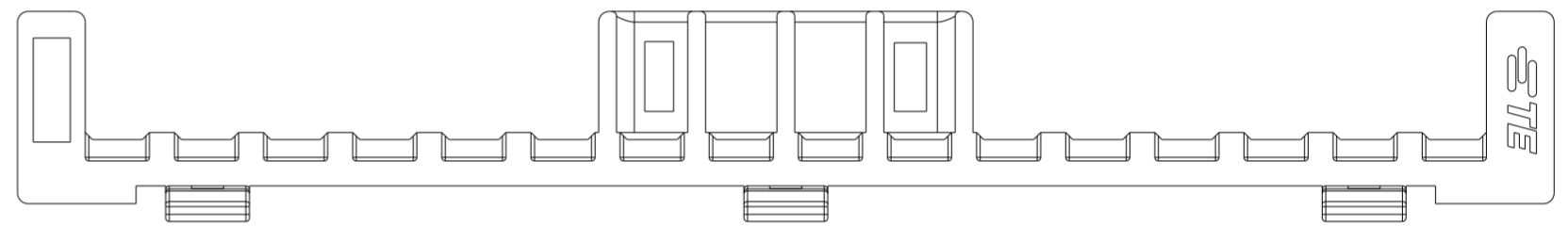

1-1969825-6

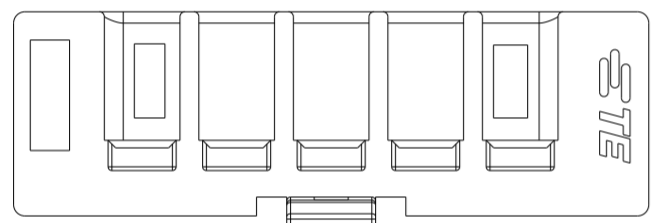

1969825-5

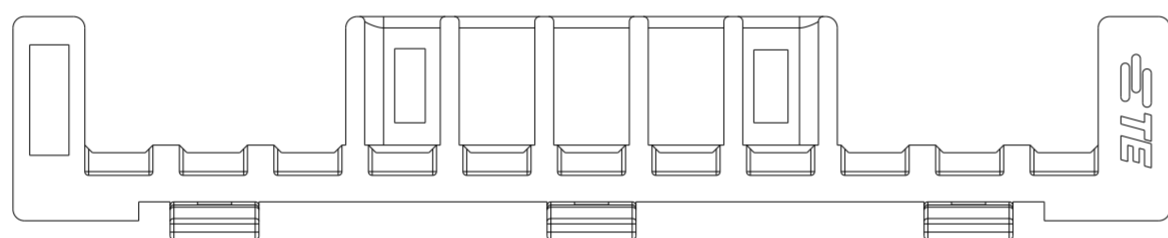

1-1969825-1

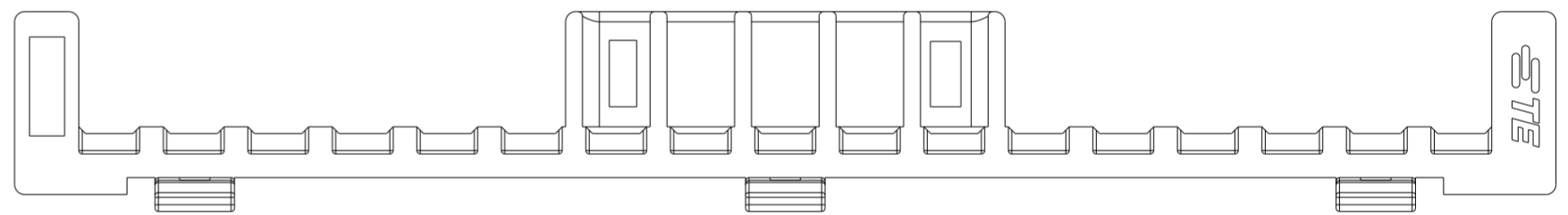

1-1969825-7

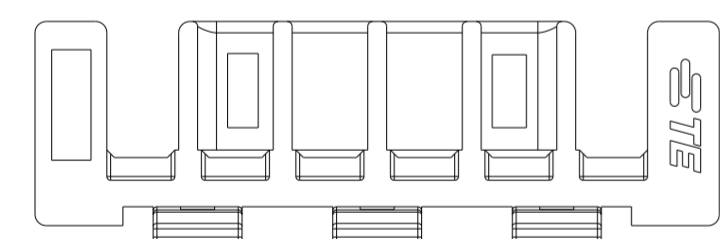

1969825-6

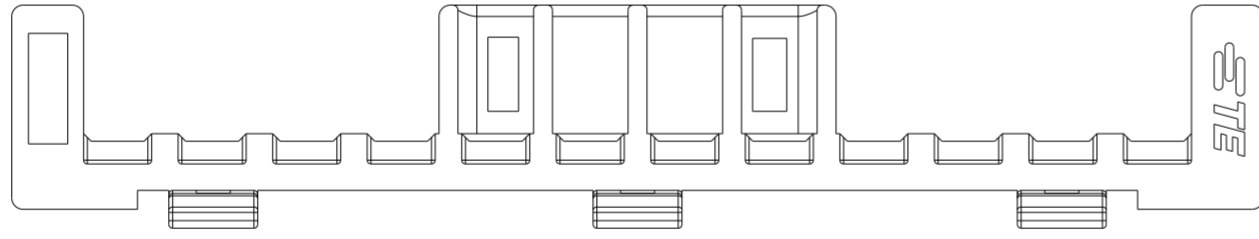

1-1969825-2

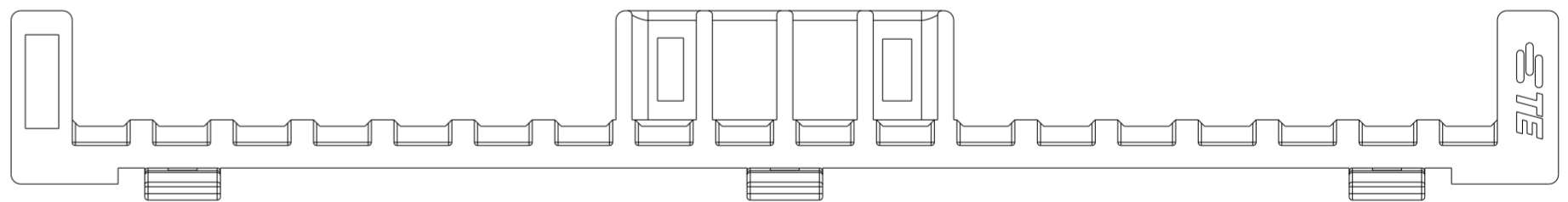

1-1969825-8

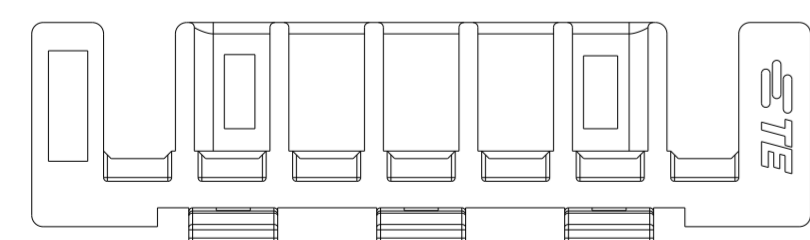

1969825-7

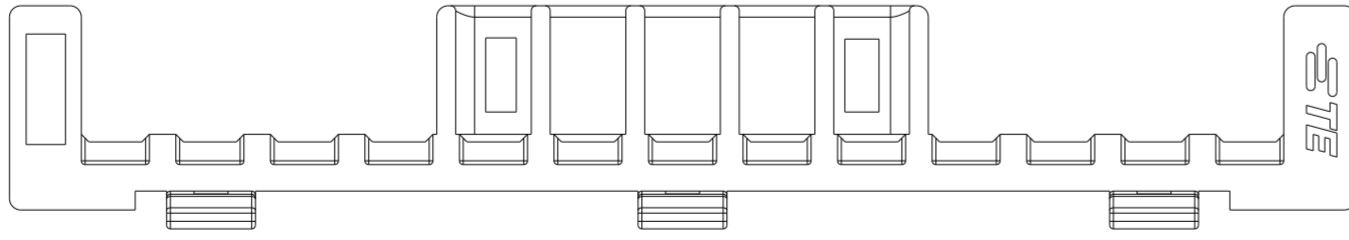

1-1969825-3

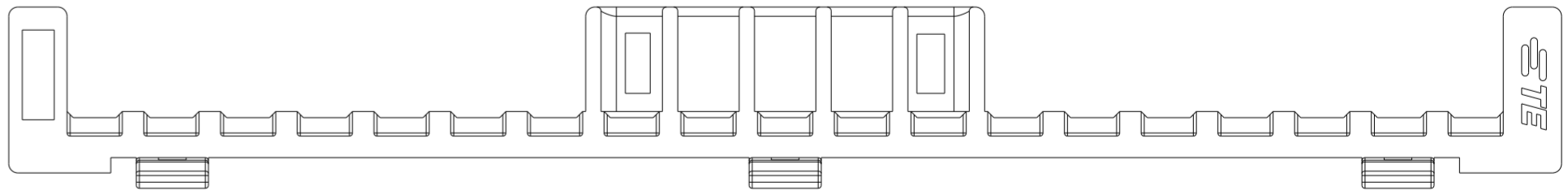

1-1969825-9

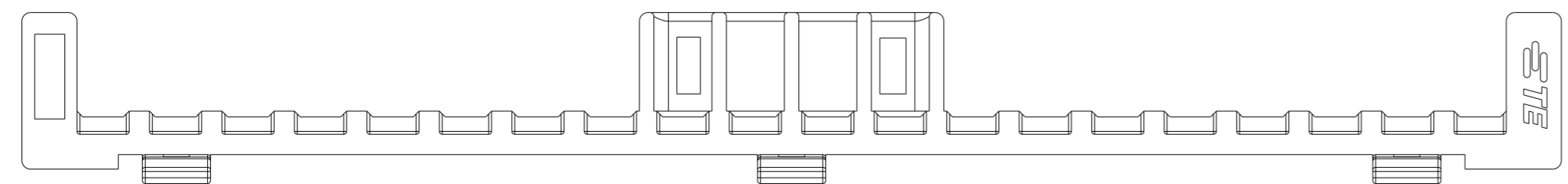

2-1969825-0

THIS DRAWING IS A CONTROLLED DOCUMENT.		DWN	JR RUTH 20-Jan-16		 TE Connectivity	NAME		ECONOMY POWER 2.5 TPA RETAINER		
DIMENSIONS:		CHK	D. FAROLE 20JAN16			SIZE	CAGE CODE	DRAWING NO	RESTRICTED TO	
mm		APVD	D. FAROLE 20JAN16			A2	-	C-1969825	-	
		PRODUCT SPEC	-			SCALE	N/A	SHEET	2	OF 2
TOLERANCES UNLESS OTHERWISE SPECIFIED:		APPLICATION SPEC	-		WEIGHT	-		REV	B2	
0 PLC	±	-		CUSTOMER DRAWING	-		-			
1 PLC	±	-		-		-		-		
2 PLC	±0.13	-		-		-		-		
3 PLC	±	-		-		-		-		
4 PLC	±	-		-		-		-		
ANGLES	±	-		-		-		-		
FINISH	±	-		-		-		-		