

P	LTR	DESCRIPTION	DATE	DWN	APVD

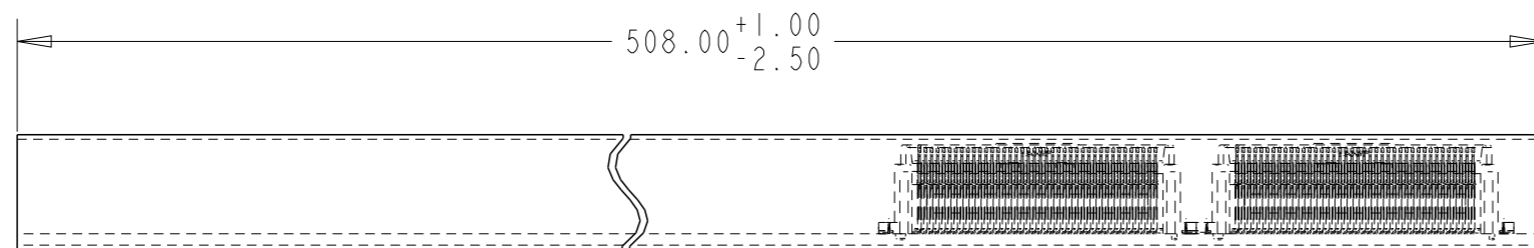

SCALE 1:1

SEE DETAIL A

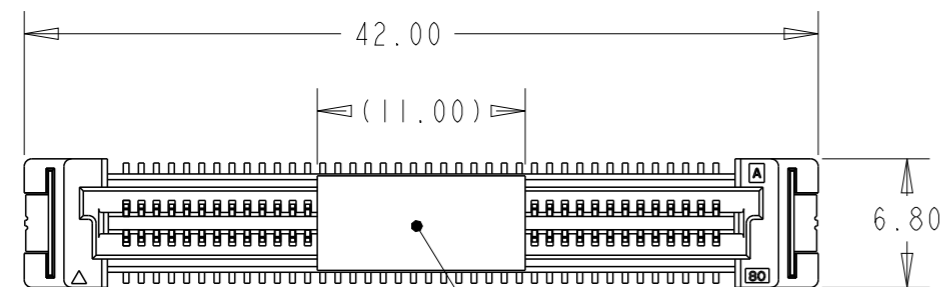
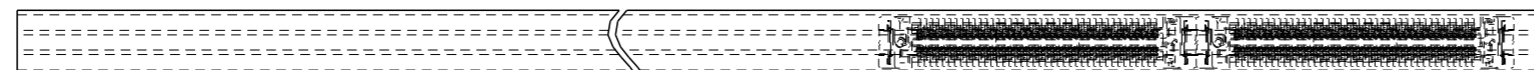

MYLAR

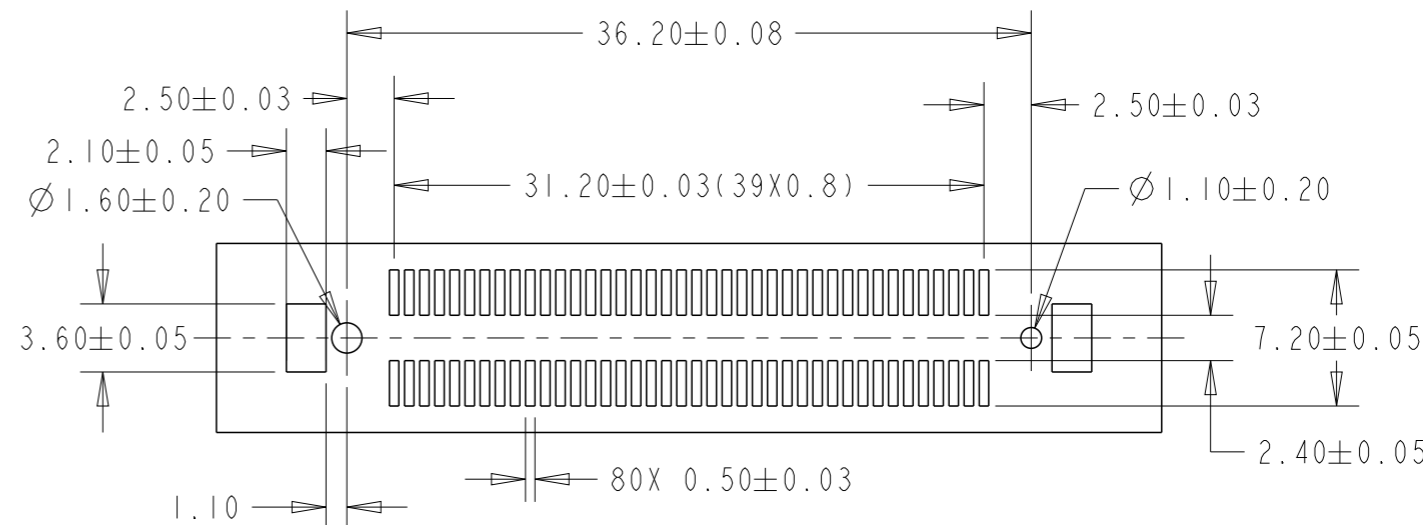
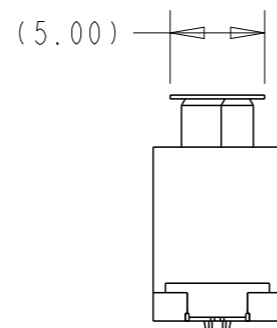
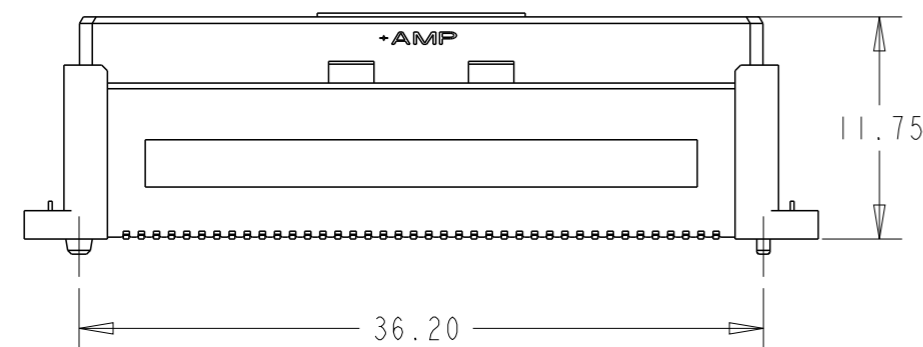

SCALE 5:2  
RECOMMENDED FOOTPRINT

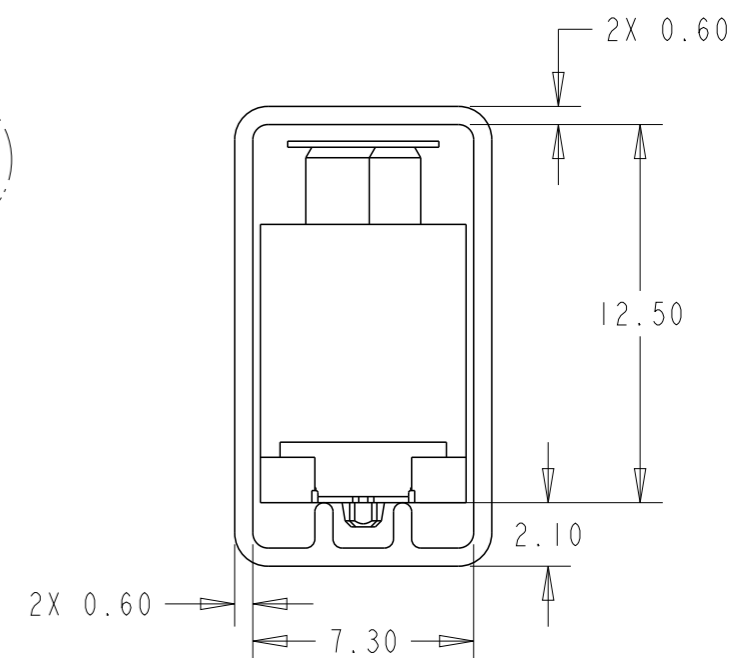

DETAIL A  
SCALE 4:1

2-1939479-3  
P/N

THIS DRAWING IS A CONTROLLED DOCUMENT.		DWN ART LIN	19JUL2022	TE Connectivity	
DIMENSIONS: mm		CHK A.L	-		
TOLERANCES UNLESS OTHERWISE SPECIFIED:		APVD H.L	-	NAME REC ASSY WITH SOLDER PEG IN TUBE 0.76um Au, 13H 0.8FH, REC WITH MYLAR	
0 PLC ± 1 PLC ±0.3 2 PLC ±0.3 3 PLC ±0.2 4 PLC ±0.1 ANGLES ±3°		PRODUCT SPEC	-	SIZE A3	CAGE CODE 00779
MATERIAL material_2		APPLICATION SPEC	-	DRAWING NO C=1939479C	RESTRICTED TO -
FINISH finish_spec_2		WEIGHT	-	SCALE 1:1	SHEET 1 OF 1
CUSTOMER DRAWING			REV B		