

REVISIONS

P	LTR	DESCRIPTION	DATE	DWN	APVD
	C	REVISED	ECR-17-012605	25JAN2018	YN TK

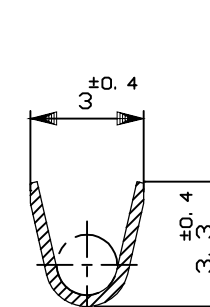

SECT A-A

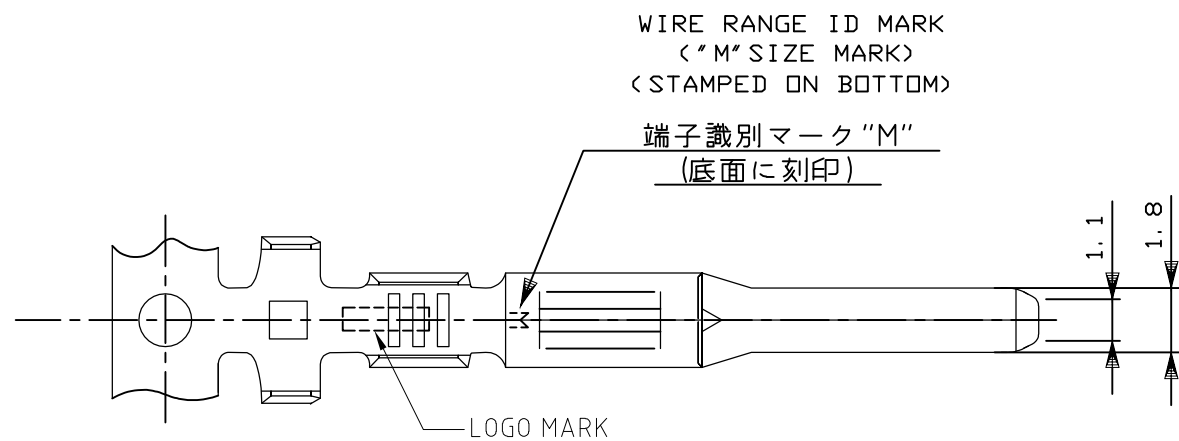
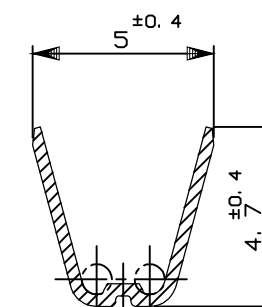

SECT B-B

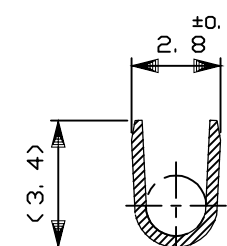
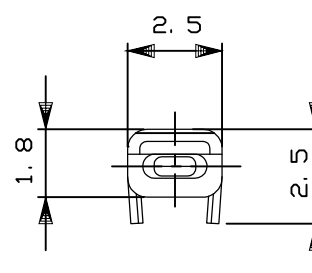
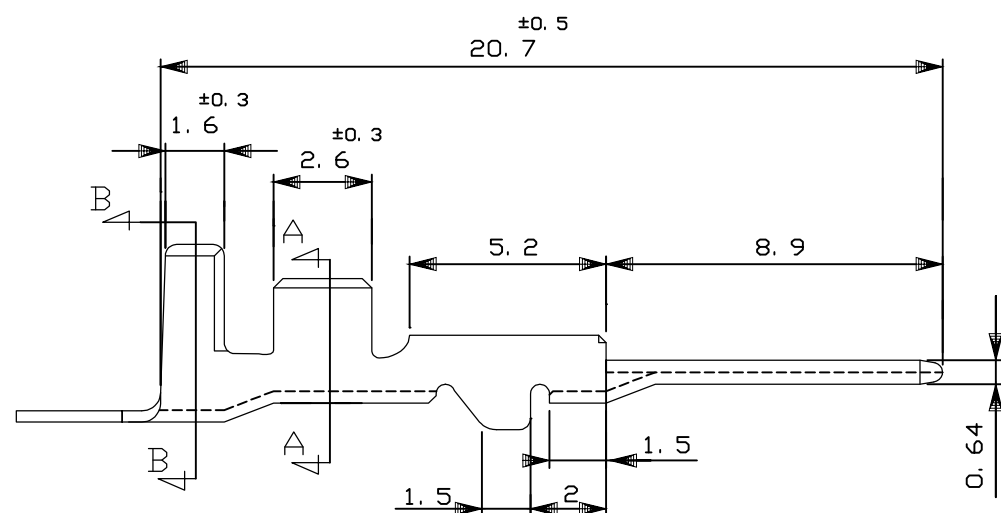

SECT A-A  
(175205のみ適用)  
<ONLY 175205>

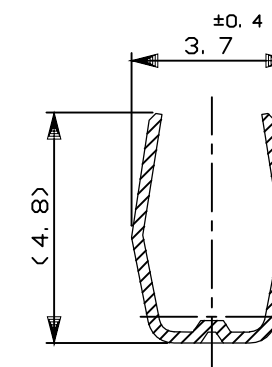

SECT B-B  
(175205のみ適用)  
<ONLY 175205>

- 1. 製品規格; 108-5264
- 2. 圧着工具については、AMP-GB 開発の工具を使用のこと。

- 1. SPEC:108-5264
- 2. TO USE TOOL MADE BY AMP-GB ONLY.

175205-1	錫めっき済 PRE-TINNED	黄銅 板厚0.32 BRASS t0.32	175191-1
バラ端子型番 L/P NUMBER	仕上 FINISH	材料 MATERIAL	型番 PART NUMBER

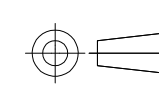
THIS DRAWING IS A CONTROLLED DOCUMENT.		DWN N.OJIMA 08JAN1990	 TE Connectivity Ltd.			
DIMENSIONS: mm		CHK M.OSHIMA 08JAN1990				
TOLERANCES UNLESS OTHERWISE SPECIFIED:		APVD M.NOGUCHI 08JAN1990				
		NAME				
TOLERANCES UNLESS OTHERWISE SPECIFIED: 一般公差 0 < x < 10: ±0.2 10 < x < 30: ±0.25 30 < x < 100: ±0.3 ANGLE: ±3°		PRODUCT SPEC	070 SERIES TAB CONTACT			
MATERIAL SEE TABLE		FINISH	SIZE	CAGE CODE	DRAWING NO	RESTRICTED TO
SEE TABLE		SEE TABLE	A300779		C-175191	—
CUSTOMER DRAWING			SCALE	SHEET	REV	
			5:1	1 OF 1	C	