

LOC	DIST	REVISIONS					
E	B	P	LTR	DESCRIPTION	DATE	DWN	APVD
		BC		NEW RELEASE	13NOV2010	PT	St.P

FOR FURTHER INFORMATION SEE DATA SHEET FOR  
RN73 SERIES-HIGH PRECISION RESISTORS (SMD)

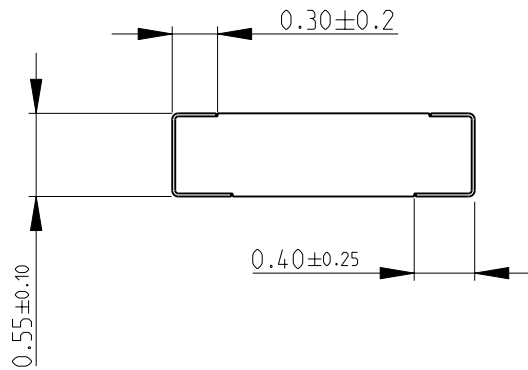

RECOMMENDED LAND PATTERN

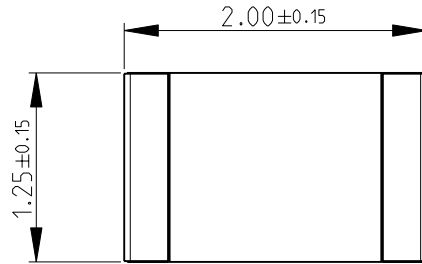
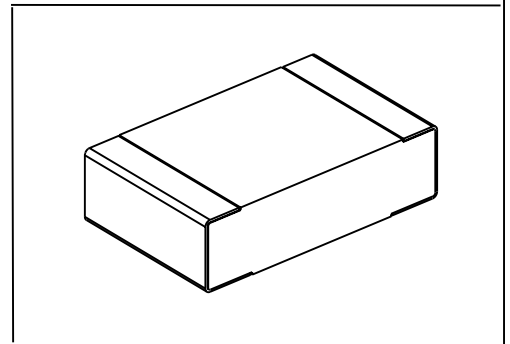
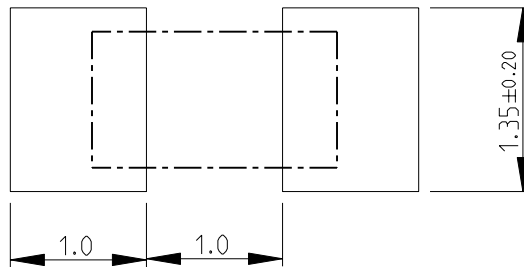

2010

RELEASED FOR PUBLICATION

BY TYCO ELECTRONICS CORPORATION. ALL RIGHTS RESERVED.

THIS DRAWING IS UNPUBLISHED.



DIMENSIONS: mm	DWN	13NOV2010	MATERIAL	-	FINISH	-
	PARUSURAM.T					
TOLERANCES UNLESS OTHERWISE SPECIFIED:	CHK	10NOV2010	Tyco Electronics Corporation Dorcan, Swindon, SN3 5HH			
	ALLAN.P					
0 PLC ±0.2	APVD	10NOV2010	NAME HIGH PRECISION RESISTORS (SMD) SERIES RN73 2A			
1 PLC ±0.1	STEPHEN.P					
2 PLC ±-	PRODUCT SPEC	-	SIZE	CAGE CODE	DRAWING NO	RESTRICTED TO
3 PLC ±-	APPLICATION SPEC	-	A 4	00779	©- 1676328	-
4 PLC ±-	WEIGHT	-	CUSTOMER DRAWING			
ANGLES ±5°			SCALE	20:1	SHEET	1 OF 1
						REV BC