

THIS DRAWING IS UNPUBLISHED. RELEASED FOR PUBLICATION
 © COPYRIGHT -- By -- ALL RIGHTS RESERVED.

REVISIONS				
P	LYR	DESCRIPTION	DATE	OWN APVD
B		REV PER ECO 18-005353	5-3-18	CT AS

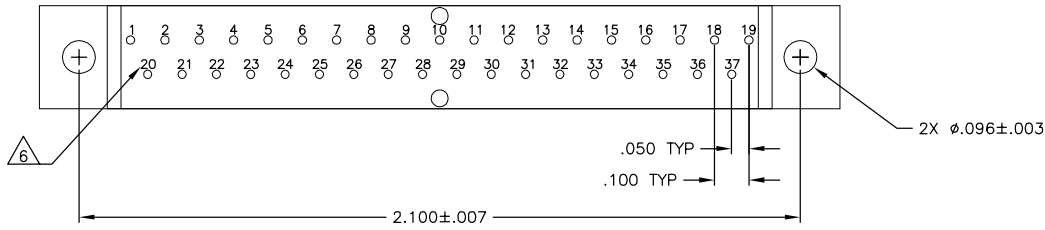
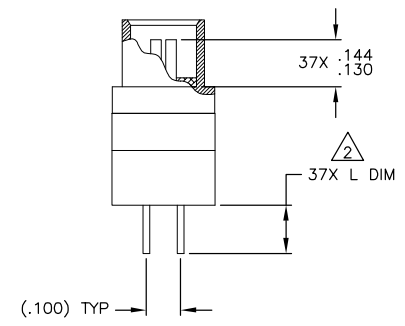
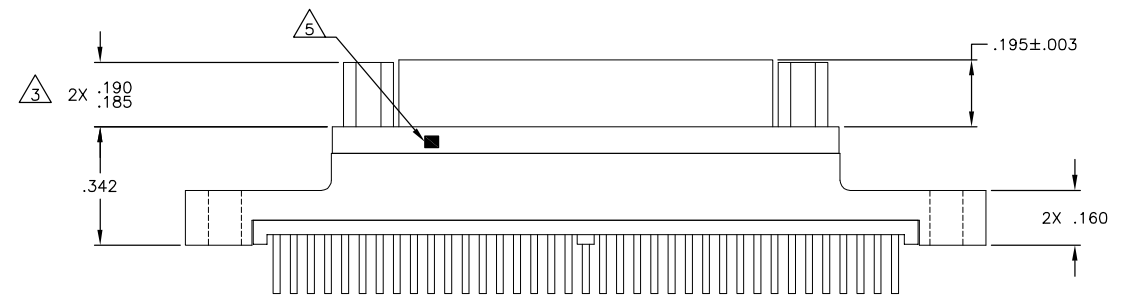
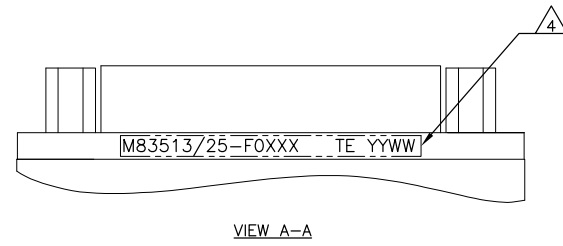
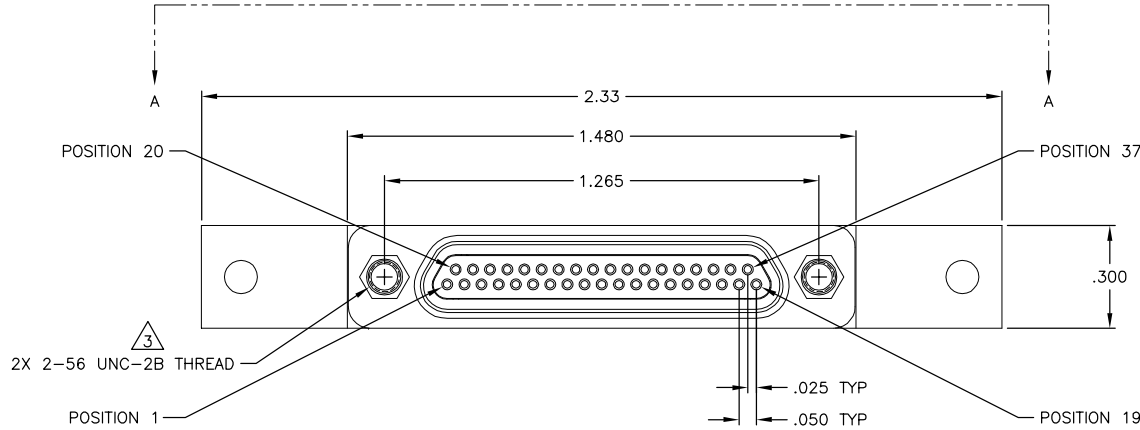

JACKPOSTS OMITTED FOR CLARITY

SEE SHEET 2 FOR NOTES

THIS DRAWING IS A CONTROLLED DOCUMENT.		DWN C SCHOLL	2 JUL 12	TE Connectivity	
DIMENSIONS: INCHES		CHK M STORREY	2 JUL 12		
TOLERANCES UNLESS OTHERWISE SPECIFIED: 0 PLC ± - 1 PLC ± - 2 PLC ± .010 3 PLC ± .005 4 PLC ± - ANGLES ± 1°		NAME		RECEPTACLE ASSY, MCKS, ST1 STRAIGHT TERMINATION, PCB MOUNT, 2 ROW, PER MIL-DTL-83513/25	
MATERIAL SEE NOTES		FINISH SEE NOTES		SIZE A2	CAGE CODE 98278
		WEIGHT		DRAWING NO 1532279	RESTRICTED TO
		CUSTOMER DRAWING		SCALE 4:1	SHEET 1 of 2
				REV B	



1532279

THIS DRAWING IS UNPUBLISHED. RELEASED FOR PUBLICATION
 © COPYRIGHT - By - ALL RIGHTS RESERVED.

REVISIONS					
P	LYR	DESCRIPTION	DATE	DWN	APVD
-	-	SEE SHEET 1	-	-	-

TE PART NUMBER	MIL-DTL-83513 PIN	MCKS DESCRIPTION	SHELL FINISH $\triangle 1$	HARDWARE $\triangle 3$	L DIM $\pm .015$
1532279-1	M83513/25-F01CN	MCKS-C2-B-37SST1	CADMIUM	NONE	.109
1532279-2	M83513/25-F01CP	MCKS-C2-P-37SST1	CADMIUM	JACKPOSTS	.109
1532279-3	M83513/25-F01NN	MCKS-N1-B-37SST1	NICKEL	NONE	.109
1532279-4	M83513/25-F01NP	MCKS-N1-P-37SST1	NICKEL	JACKPOSTS	.109
1532279-5	M83513/25-F02CN	MCKS-C2-B-37SST1A	CADMIUM	NONE	.140
1532279-6	M83513/25-F02CP	MCKS-C2-P-37SST1A	CADMIUM	JACKPOSTS	.140
1532279-7	M83513/25-F02NN	MCKS-N1-B-37SST1A	NICKEL	NONE	.140
1532279-8	M83513/25-F02NP	MCKS-N1-P-37SST1A	NICKEL	JACKPOSTS	.140
1532279-9	M83513/25-F03CN	MCKS-C2-B-37SST1B	CADMIUM	NONE	.172
1-1532279-0	M83513/25-F03CP	MCKS-C2-P-37SST1B	CADMIUM	JACKPOSTS	.172
1-1532279-1	M83513/25-F03NN	MCKS-N1-B-37SST1B	NICKEL	NONE	.172
1-1532279-2	M83513/25-F03NP	MCKS-N1-P-37SST1B	NICKEL	JACKPOSTS	.172

- $\triangle 1$ SHELL MATERIAL: 6061-T6 ALUMINUM
 FINISH OPTIONS:
 ELECTROLESS NICKEL PLATED PER SAE-AMS-C-26074 OR SAE AMS 2404 OR CADMIUM PLATED PER SAE-AMS-QQ-P-416 WITH YELLOW CHROMATE
 INSULATOR: LIQUID CRYSTAL POLYMER (LCP)
 HARDWARE: 300 SERIES STAINLESS STEEL
 TB BOX: POLYPHENYLENE SULFIDE (PPS) AND EPOXY POTTING
- $\triangle 2$ TERMINATION: 24AWG GOLD PLATED COPPER WIRE, Sn63Pb37 SOLDER DIPPED UP TO MOUNTING SURFACE AT A MINIMUM
- $\triangle 3$ JACKPOST HARDWARE SHALL BE PERMANENTLY INSTALLED AS SHOWN WHEN REQUIRED BY THE MIL PIN. JACKPOST DIMENSIONS AND REQUIREMENTS ARE DEFINED IN MIL-DTL-83513/5.
- $\triangle 4$ CONNECTOR SHALL BE MARKED IN ACCORDANCE WITH METHOD 1 OF MIL-STD-1285. MARKING SHALL CONTAIN THE MILITARY PIN, CAGE CODE (OR TE), AND DATE CODE. EXAMPLE: M83513/25-FOXXX TE YYWW (WHERE XXX IS PART OF THE PIN SHOWN IN THE "MIL-DTL-83513 PIN" COLUMN OF THE PART NUMBER TABLE, AND YYWW IS THE DATE CODE). THE MARKING MUST BE PRINTED ON THE FLANGE. TEXT HEIGHT SHALL BE .035 INCH MINIMUM.
- $\triangle 5$ POSITION 1 SHALL BE INDICATED BY AN IDENTIFIABLE MARK, LOCATED APPROXIMATELY AS SHOWN ON THE POSITION 1 SIDE OF THE CONNECTOR FLANGE. THIS MARK SHALL BE INCLUDED AS PART OF THE PART MARKING INFORMATION.
- $\triangle 6$ TERMINAL IDENTIFICATION NUMBERS AS SHOWN DO NOT ACTUALLY APPEAR ON THE PART (FOR IDENTIFICATION ONLY)
- 7 ALL REQUIREMENTS CONFORM TO MIL-DTL-83513/25. SEE MIL-SPEC FOR DETAILED INTERFACE DIMENSIONS AND SUGGESTED PCB LAYOUTS

THIS DRAWING IS A CONTROLLED DOCUMENT.		DWN C SCHOLL	2 JUL 12	 TE Connectivity
DIMENSIONS: INCHES		APVD M STORREY	2 JUL 12	
		TOLERANCES UNLESS OTHERWISE SPECIFIED: 0 PLC ± - 1 PLC ± - 2 PLC ± .010 3 PLC ± .005 4 PLC ± - ± .1* ANGLES ± - ± .1*		NAME RECEPTACLE ASSY,MCKS,ST1 STRAIGHT TERMINATION,PCB MOUNT,2 ROW, PER MIL-DTL-83513/25
MATERIAL SEE NOTES	FINISH SEE NOTES	WEIGHT -	RESTRICTED TO -	SIZE A2
CUSTOMER DRAWING		SCALE 4:1	SHEET 2 of 2	REV B

1532279