

THIS DRAWING IS UNPUBLISHED. RELEASED FOR PUBLICATION
 © COPYRIGHT -- By -- ALL RIGHTS RESERVED.

REVISIONS				
P	LYR	DESCRIPTION	DATE	DWN APVD
B		REV PER ECO 18-005354	5-3-18	CT AS

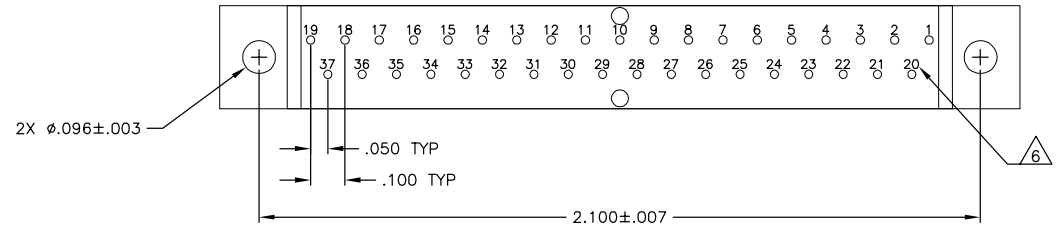
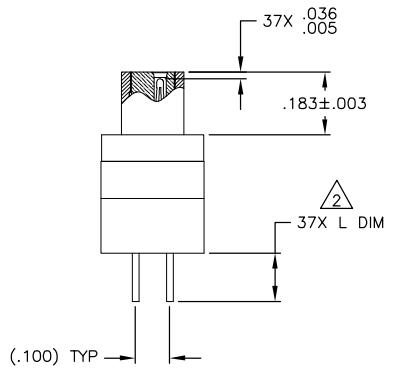
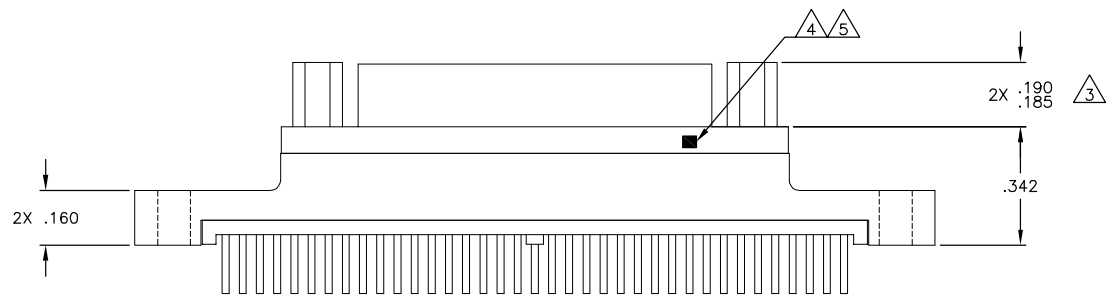
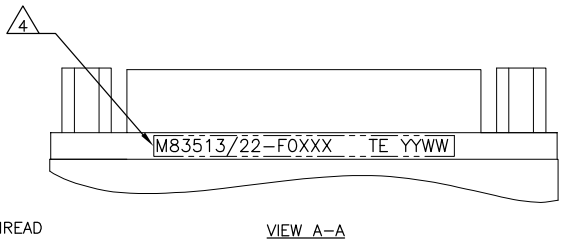
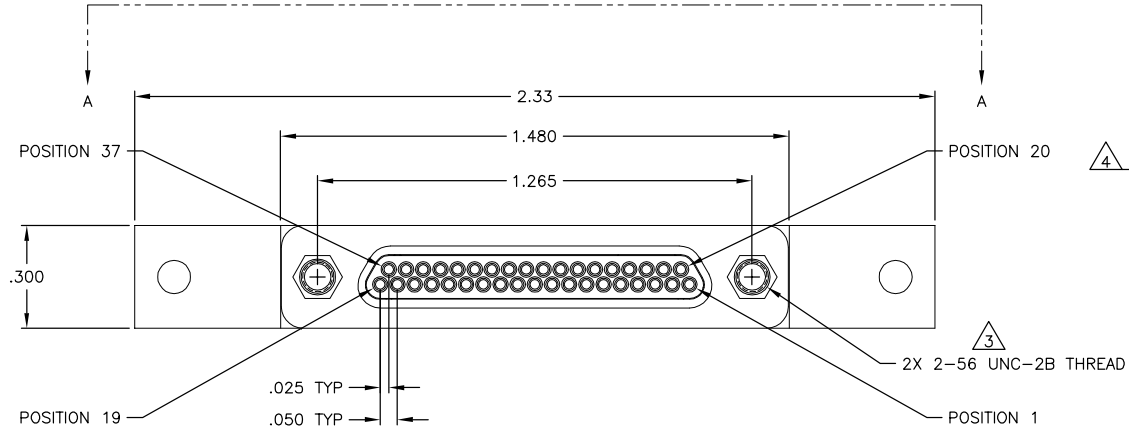

SEE SHEET 2 FOR NOTES

THIS DRAWING IS A CONTROLLED DOCUMENT.		DWN C SCHOLL	2 JUL 12	TE Connectivity	
DIMENSIONS: INCHES		DWG M STOREY	2 JUL 12		
TOLERANCES UNLESS OTHERWISE SPECIFIED: 0 PLC ± -- 1 PLC ± -- 2 PLC ± .010 3 PLC ± .005 4 PLC ± -- ANGLES ± 1°		NAME		PLUG ASSEMBLY, MCKS, ST1 STRAIGHT TERMINATION, PCB MOUNT, 2 ROW, SIZE 37, PER MIL-DTL-83513/22	
MATERIAL SEE NOTES		FINISH SEE NOTES		SIZE A2	RESTRICTED TO
SEE NOTES		SEE NOTES		CAGE CODE 98278	DRAWING NO 1532271
SEE NOTES		SEE NOTES		WEIGHT --	SCALE 4:1
SEE NOTES		SEE NOTES		CUSTOMER DRAWING	SHEET 1 of 2
SEE NOTES		SEE NOTES		REV B	



1532271

THIS DRAWING IS UNPUBLISHED. RELEASED FOR PUBLICATION
 © COPYRIGHT - By - ALL RIGHTS RESERVED.

REVISIONS					
P	LTR	DESCRIPTION	DATE	DWN	APVD
-	-	SEE SHEET 1	-	-	-

TE PART NUMBER	MIL-DTL-83513 PIN	MCKS DESCRIPTION	SHELL FINISH ¹	HARDWARE ³	L DIM±.015
1532271-1	M83513/22-F01CN	MCKS-C2-B-37PST1	CADMIUM	NONE	.109
1532271-2	M83513/22-F01CP	MCKS-C2-P-37PST1	CADMIUM	JACKPOSTS	.109
1532271-3	M83513/22-F01NN	MCKS-N1-B-37PST1	NICKEL	NONE	.109
1532271-4	M83513/22-F01NP	MCKS-N1-P-37PST1	NICKEL	JACKPOSTS	.109
1532271-5	M83513/22-F02CN	MCKS-C2-B-37PST1A	CADMIUM	NONE	.140
1532271-6	M83513/22-F02CP	MCKS-C2-P-37PST1A	CADMIUM	JACKPOSTS	.140
1532271-7	M83513/22-F02NN	MCKS-N1-B-37PST1A	NICKEL	NONE	.140
1532271-8	M83513/22-F02NP	MCKS-N1-P-37PST1A	NICKEL	JACKPOSTS	.140
1532271-9	M83513/22-F03CN	MCKS-C2-B-37PST1B	CADMIUM	NONE	.172
1-1532271-0	M83513/22-F03CP	MCKS-C2-P-37PST1B	CADMIUM	JACKPOSTS	.172
1-1532271-1	M83513/22-F03NN	MCKS-N1-B-37PST1B	NICKEL	NONE	.172
1-1532271-2	M83513/22-F03NP	MCKS-N1-P-37PST1B	NICKEL	JACKPOSTS	.172

- ¹ SHELL MATERIAL: 6061-T6 ALUMINUM
 FINISH OPTIONS:
 ELECTROLESS NICKEL PLATED PER SAE-AMS-C-26074 OR SAE AMS 2404 OR CADMIUM PLATED PER SAE-AMS-QQ-P-416 WITH YELLOW CHROMATE
 INSULATOR: LIQUID CRYSTAL POLYMER (LCP)
 HARDWARE: 300 SERIES STAINLESS STEEL
 TB BOX: POLYPHENYLENE SULFIDE (PPS) AND EPOXY POTTING
- ² TERMINATION: 24AWG GOLD PLATED COPPER WIRE, Sn63Pb37 SOLDER DIPPED UP TO MOUNTING SURFACE AT A MINIMUM
- ³ JACKPOST HARDWARE SHALL BE PERMANENTLY INSTALLED AS SHOWN WHEN REQUIRED BY THE MIL PIN. JACKPOST DIMENSIONS AND REQUIREMENTS ARE DEFINED IN MIL-DTL-83513/5.
- ⁴ CONNECTOR SHALL BE MARKED IN ACCORDANCE WITH METHOD 1 OF MIL-STD-1285. MARKING SHALL CONTAIN THE MILITARY PIN, CAGE CODE (OR TE), AND DATE CODE. EXAMPLE: M83513/22-F0XXX TE YYWW (WHERE XXX IS PART OF THE PIN SHOWN IN THE "MIL-DTL-83513 PIN" COLUMN OF THE PART NUMBER TABLE, AND YYWW IS THE DATE CODE). THE MARKING MUST BE PRINTED ON THE FLANGE. TEXT HEIGHT SHALL BE .035 INCH MINIMUM.
- ⁵ POSITION 1 SHALL BE INDICATED BY AN IDENTIFIABLE MARK, LOCATED APPROXIMATELY AS SHOWN ON THE POSITION 1 SIDE OF THE CONNECTOR FLANGE. THIS MARK SHALL BE INCLUDED AS PART OF THE PART MARKING INFORMATION.
- ⁶ TERMINAL IDENTIFICATION NUMBERS AS SHOWN DO NOT ACTUALLY APPEAR ON THE PART (FOR IDENTIFICATION ONLY)
- 7 ALL REQUIREMENTS CONFORM TO MIL-DTL-83513/22. SEE MIL-SPEC FOR DETAILED INTERFACE DIMENSIONS AND SUGGESTED PCB LAYOUTS

THIS DRAWING IS A CONTROLLED DOCUMENT.		DWG C SCHOLL	2 JUL 12	 TE Connectivity			
DIMENSIONS: INCHES		CHK -	-				
		TOLERANCES UNLESS OTHERWISE SPECIFIED: 0 PLC ± - 1 PLC ± - 2 PLC ± .010 3 PLC ± .005 4 PLC ± - ± .1* ANGLES ± - ± .1*		APVD M STORREY 2 JUL 12 PRODUCT SPEC APPLICATION SPEC	NAME PLUG ASSEMBLY, MCKS, ST1 STRAIGHT TERMINATION, PCB MOUNT, 2 ROW, SIZE 37, PER MIL-DTL-83513/22		
MATERIAL SEE NOTES		FINISH SEE NOTES		SIZE A2	CAGE CODE 98278	DRAWING NO 1532271	RESTRICTED TO -
CUSTOMER DRAWING				SCALE 4:1	SHEET 2 of 2	REV B	

1532271