

THIS DRAWING IS UNPUBLISHED. RELEASED FOR PUBLICATION  
 © COPYRIGHT BY TYCO ELECTRONICS CORPORATION. ALL RIGHTS RESERVED.

LOC	DIST	REVISIONS					
		P	LTR	DESCRIPTION	DATE	DWN	APVD
G	14		D	REV PER ECR 07-026901	10JAN08	JR	TM

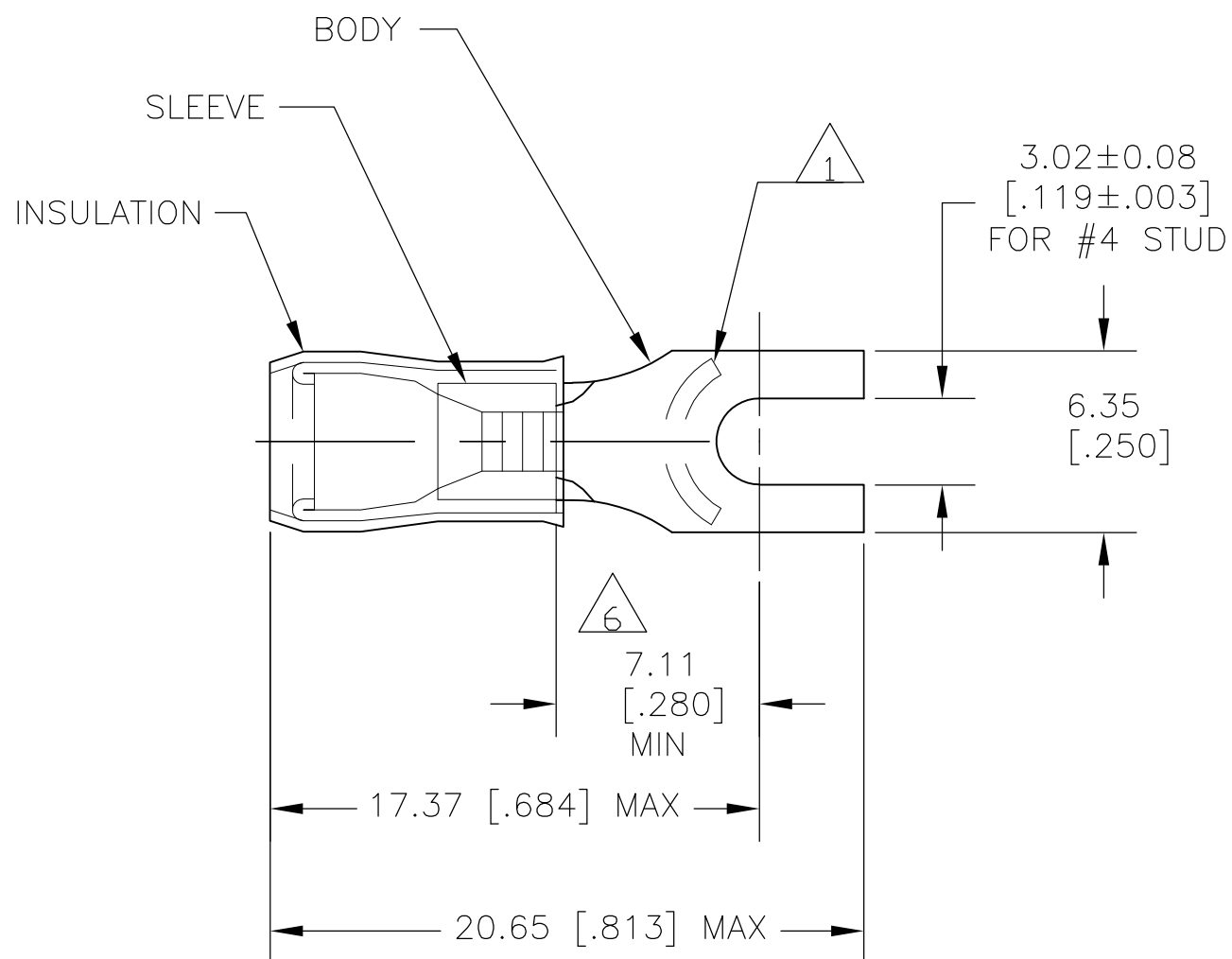

- 1 STAMP AMP 16-14 APPROX AS SHOWN
- 2 WIRE INSULATION DIA: 2.7-3.8 [.105-.150]
- 3 TONGUE MATERIAL THK: 0.78±0.05 [.031±.002]
- 4 BODY & SLEEVE: TIN PLATE PER ASTM B545,
- 5 BODY & SLEEVE- CU PER ASTM B152 INSULATION - NYLON, COLOR - BLUE
- 6 APPLIES FROM EDGE OF METAL WIRE BARREL TO CENTER OF STUD HOLE.

OBSOLETE	-5000	ON TAPE	2-130526-1
	1000	LOOSE PIECE	130526
	QTY	PACKAGE TYPE	PART NO

AMP INCORPORATED CUSTOMER SERVICE SYSTEMS		MAX RECOMMENDED OPERATING TEMPERATURE: 150°C MAX	THIS DRAWING IS A CONTROLLED DOCUMENT.		DWN JR RUTH 10JAN08	Tyco Electronics Corporation Harrisburg, Pa 17105-3608	
FOR ADDITIONAL PRODUCT INFORMATION OR COPIES OF DRAWINGS AND TECHNICAL DOCUMENTS	PRODUCT INFORMATION CENTER 1-800-522-6752	VOLTAGE RATING: -	DIMENSIONS: MM [INCHES]	TOLERANCES UNLESS OTHERWISE SPECIFIED:	CHK T MICHIELUTTI 10JAN08	NAME TERMINAL, RECTANGULAR TONGUE, P.I.D.G. WIRE SIZE: 16-14 AWG	
FOR APPLICATION TOOLING INFORMATION	TOOLING ASSISTANCE CENTER 1-800-722-1111	CIRCULAR MIL AREA: 1.04-2.62mm <sup>2</sup> [2,050-5,180] STRANDED		0 PLC ± - 1 PLC ± - 2 PLC ± - 3 PLC ± - 4 PLC ± - ANGLES ± -	APVD T MICHIELUTTI 10JAN08	APPLICATION SPEC	SIZE A3
FOR ORDER ENTRY	1-800-526-5142	THIS DRAWING IS A CONTROLLED DOCUMENT FOR AMP INCORPORATED. IT IS SUBJECT TO CHANGE AND THE CONTROLLING ENGINEERING ORGANIZATION SHOULD BE CONTACTED FOR THE LATEST REVISION.	MATERIAL - 5	FINISH - 4	PRODUCT SPEC	RESTRICTED TO	CAGE CODE 00779
					WEIGHT -	DRAWING NO G-130526	SCALE 4:1
					CUSTOMER DRAWING		SHEET 1 OF 1
							REV D