

INSULATORS

Quick Reference Guide

THERE'S ONLY ONE NAME YOU NEED TO KNOW

TE Connectivity covers a wide range of polymeric, ceramic and hybrid insulators. For decades these products have demonstrated reliable performance in various types of applications all over the world.

- **Composite insulators** are based on Raychem's 40 years experience in the field of crosslinked polymers for medium and high voltage applications. They consist of a polymeric housing over a pultruded fibreglass rod to which galvanised steel or aluminium end fittings are attached. By moulding directly over the end fitting, or by using a track resistant polyurethane sealant, moisture ingress to the fibreglass rod is prevented. Housing materials in either ethylene vinyl acetate or silicone are available depending on customer preference.
- **Porcelain insulators** are the traditional choice for distribution line, busbar and apparatus insulation. Manufactured from high quality non-porous electrical porcelain, they provide a long life and cost-effective solution for the majority of applications. TE's porcelain insulators were also known by the brand names of Morlynn, Dulmison and Zibo, and have 100 years' service experience in electric power supply and rail applications.
- **Hybrid insulators** consist of a high strength porcelain core with a polymeric housing. The best features of ceramic and polymeric insulators are combined, resulting in high mechanical strength and excellent electrical behaviour under polluted conditions. For extremely polluted environments a protected creepage design is available which provides outstanding electrical performance using an economical solution.



Raychem

MORLYNN

ZIBO

Station Post Insulators

Specifying Station Post Insulators.....	6
Calculating Creepage Distance	7
Standard Tolerances	8
Porcelain.....	9
Composite.....	10

Line Post Insulators

Specifying Line Post Insulators	14
Standard End Fittings	15
Standard Tolerances	16
Porcelain.....	17
Composite.....	18
Hybrid.....	19

String Insulator Units

Specifying Disc Insulators.....	22
Electrical Properties of Insulator Strings	23
Porcelain and Glass Discs	24
Specifying Composite Longrod Insulators.....	25
Designation of Composite Longrod Insulators.....	25
Standard Tolerances	25
Composite Longrods - Distribution.....	26
Composite Longrods - Transmission.....	27

Pin Insulators

Specifying Pin Insulators.....	30
Standard Characteristics for Pin Insulators.....	31
Head Types.....	32
Pin Types	33
Pin Head Patterns	33
Pin Insulators	34
Pins	34

Other Insulators

Designation of Railway Insulators	38
End Fittings.....	38
Railway Insulators	39
Specifying Strain Insulators	40
Porcelain Strain Insulators	41
Specifying Low Voltage Insulators.....	42
Standard Tolerances	42
Designation of Low Voltage Insulators.....	42
Low Voltage Insulators	42
Studs & Clamps.....	43

Appendix

44

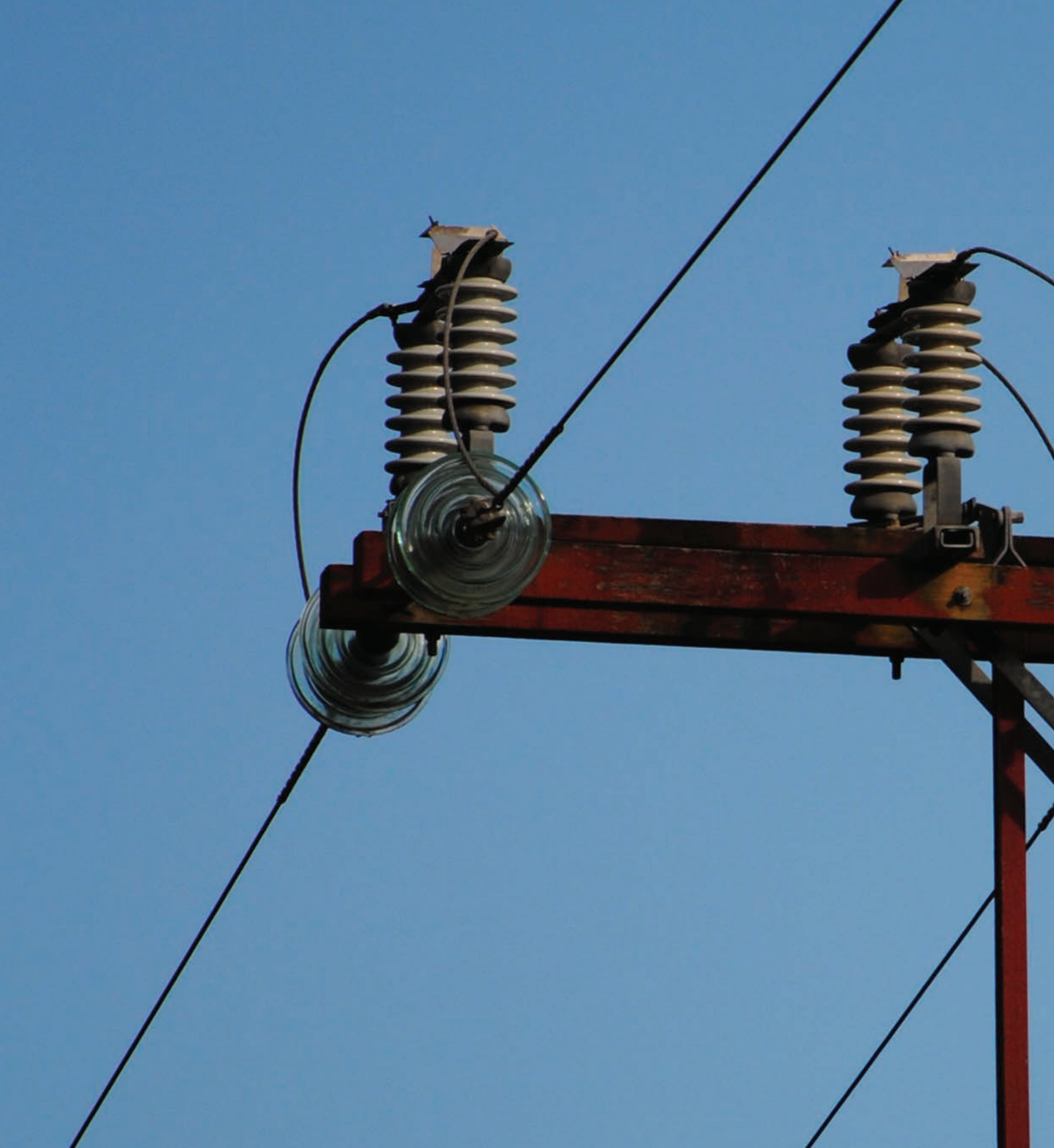

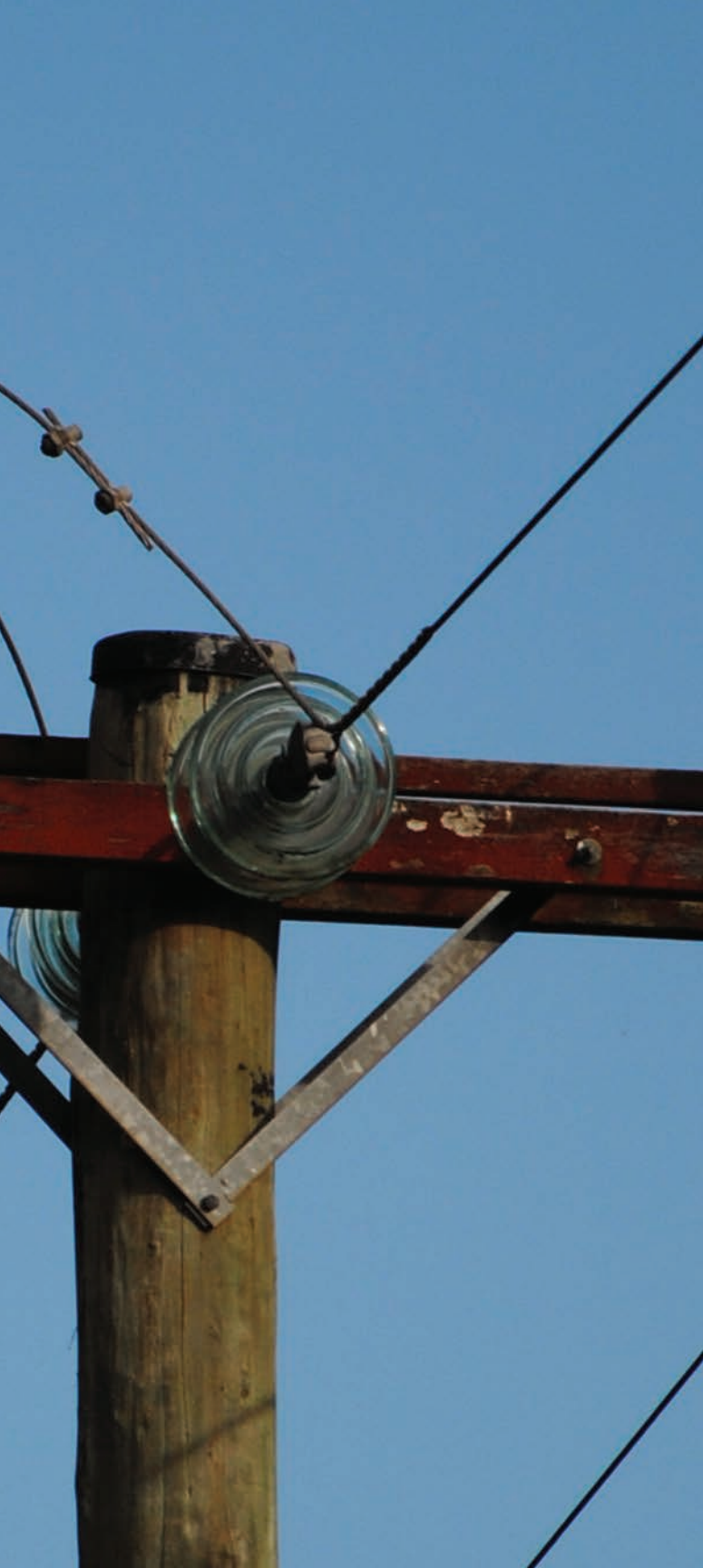

SECTION 1 STATION POST INSULATORS

Specifying Station Post Insulators	6
Designation of Station Post Insulators	6
Standard End Fittings	6
Calculating Creepage Distance	7
Standard Tolerances.....	8
Porcelain	9
Composite	10

Specifying Station Post Insulators

To specify the correct solid core station post insulator, it is necessary to define the following characteristics:

- Cantilever (bending) failure load [kN]
- Lightning Impulse Withstand Voltage (BIL) - dry [kV]
- Height [mm]
- Nominal Creepage Distance [mm]
- Fixing Arrangements for top and bottom end fittings
- Colour

For transmission applications requiring a BIL greater than 850kV, it is also necessary to define:

- Switching Impulse Withstand Voltage - wet [kV]

DESIGNATION

In accordance with AS 4398.1, standard post insulators are assigned a reference designation which indicates:

- Insulator type
- Mechanical strength
- Lightning impulse withstand voltage
- Creepage distance class

Example: C6-325-II

where

C = outdoor cylindrical post insulator with external end fittings

6 = 6kN mechanical bending strength

325 = 325kV BIL (lightning impulse withstand voltage)

II = creepage class II*

* Common utility practice employs creepage values to match four levels of pollution defined in IEC 60815 rather than the creepage classes defined in AS 4398. A worked example follows to clarify this

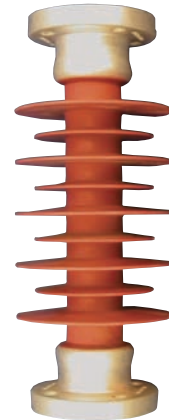

Standard End Fittings

Fittings are manufactured with malleable cast iron or spheroidal graphite cast iron, and are hot-dip galvanised to comply with the requirements of AS 4680 with an average zinc coating exceeding 600g/m² (equivalent to a thickness of 85µm).

Standard dimensions for fixing arrangements in accordance with AS 4398.1 are shown in the table below.

Threaded holes are normally tapped 0.4mm overs to cater for standard bolts which are hot-dipped galvanised.

PCD (mm)	No of Bolts	Bolt Holes (mm)		Nominal dia of mounting face (mm)
		Tapped	Plain	
76	4	M12		115
127	4	M16		165
178	4		18	225
200	4		18	245
225	4		18	270
254	8		18	300
275	8		18	320
300	8		18	345
325	8		18	370
356	8		18	400
375	8		18	420

Calculating Creepage Distance

Specifications of creepage distance derive from two different IEC standards, and the terminology is often found to be difficult to grasp. The following example seeks to clarify some of the ambiguities.

AS 4398 (from IEC 60273) *Characteristics of indoor and outdoor post insulators*, defines for station post insulators two classes of creepage, class I and II.

IEC 60815 *Guide for the selection of insulators in respect of polluted conditions*, defines four levels of pollution, level I, II, III and IV. For each level it is necessary to multiply the *highest system voltage* by a specific creepage factor to calculate the *minimum nominal creepage* distance for the insulators used on the system.

QUESTION

I require a station post insulator with a BIL of 1050kV, and creepage to suit pollution level III. What creepage distance should I specify?

ANSWER

To calculate the creepage distance you need to know U_m - the highest system phase-to-phase voltage (rms) for the equipment in which the insulator will be used.

Based on IEC 60815, for pollution level III (Heavy) the minimum nominal creepage distance is calculated by the formula $25 \times U_m$

Let's assume U_m to be 245kV.

The minimum nominal creepage distance = $25 \times 245 = 6125\text{mm}$.

(Note: This is not the minimum creepage distance of the insulator. Rather, it is the minimum value a designer may select when presented with alternative options of nominal creepage distance. See the following explanation for further detail.)

You should thus specify:

Nominal Creepage Distance: at least 6125mm.

EXPLANATION

The word minimum in the expression minimum nominal creepage distance has nothing to do with the tolerance of the creepage. For the purpose of testing, tolerances are defined by AS 4398.2 *Tests on indoor and outdoor post insulators*. Clause 5.1.2 states, "The creepage distance shall be subject to the following tolerances: - when the creepage distance is specified as a nominal value, including a minimum nominal value : $\pm (0.04 d + 1.5)$ mm."

For a nominal creepage distance of 6125mm, the tolerance is thus ± 246.5 mm. For type or sample testing, the minimum acceptable creepage distance is thus 5879 mm.

Standard Tolerances

DIMENSIONS FOR WHICH NO SPECIAL TOLERANCE IS SPECIFIED:

$\pm (0.04 d + 1.5)$ mm when $d \leq 300$
 $\pm (0.025 d + 6)$ mm when $d > 300$
 where d is the checked dimension in millimetres.

CREEPAGE DISTANCE:

$\pm (0.04 d + 1.5)$ mm
 where d is the creepage distance in millimetres.

HEIGHT:

± 1 mm for posts up to 1220 mm high
 ± 2.5 mm for posts above 1220 mm, up to 1700 mm high
 ± 3.5 mm for posts above 1700 mm, up to 2300 mm high
 ± 4.5 mm for posts above 2300 mm, up to 3350 mm high

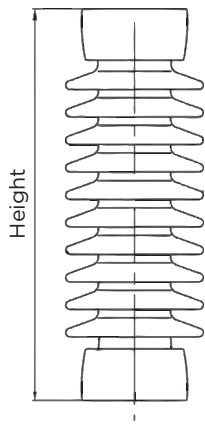

PARALLELISM OF END FACES:

for $h \leq 1$ m: 0.5 mm, where h is the height in metres.
 for $h > 1$ m: $0.5 h$ mm, where h is the height in metres.

Parallelism is measured at a diameter $D = 250$ mm.

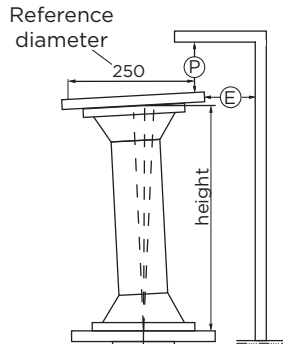

CAMBER (BEND):

not greater than: $(1.5 + 0.008 h)$ mm
 where h is the height of the post insulator unit in millimetres.

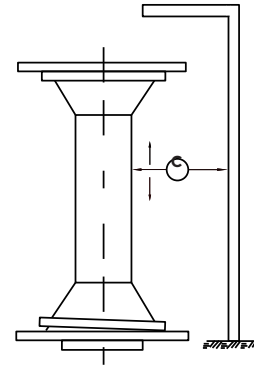

ECCENTRICITY:

$2 (1 + h)$ mm, where h is expressed in metres.

SHED ANGLE:

The mean angle of slope of the upper surface shall be subject to a tolerance of $\pm 3^\circ$.

ANGULAR DEVIATION OF FIXING HOLES:

$\pm 1^\circ$

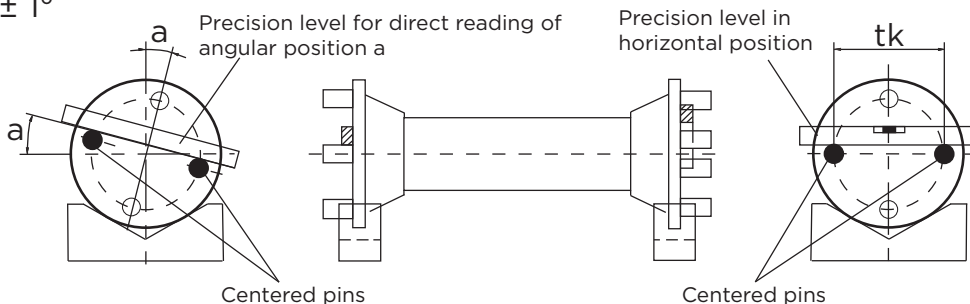

Insulators

Quick Reference Guide

TE Porcelain Station Post Insulator Range

Catalogue Reference	Nominal System Voltage (kV)	Lightning Impulse Withstand Voltage (kV)	Height (mm)	Nominal Creepage (mm)	Largest Shed Dia (mm)	Cantilever Strength (kN)	Fixing Arrangements		Approx Weight (kg)
							Thread	PCD (mm)	
SP-C6-95-305PG01	11	95	254	305	132	6	4 x M12	76	7
SP-C8-110-400PG	11	110	254	400	184	8	4 x M12	76	9
SP-C7-125-607PG	22	125	305	607	178	7	4 x M12	76	10
SP-C6-150-630PG	22	150	355	630	158	6	4 x M12	76	11
SP-C6-150-750PG	22	150	355	750	178	6	4 x M12	76	13
SP-C5-170-760PG01	22/33	170	381	760	152	5	4 x M12	76	14
SP-C4-200-885PG01	33	200	458	885	175	4	4 x M12	76	16
SP-C4-200-980PG01	33	200	458	980	175	4	4 x M12	76	17
SP-C10-200-995PG01	33	200	458	995	194	10	4 x M12	76	15
SP-C9-200-995PG	33	200	475	995	194	9	4 x M12	76	15
SP-C6-200-885PG01	33	200	508	885	178	6	4 x M12	76	20
SP-C10-250-1200PG	33	250	559	1200	194	10	4 x M12	76	23
SP-C6-350-1813PG	66	350	762	1813	182	6	4 x M16	127	34
SP-C8-350-1765PG	66	350	762	1765	195	8	4 x M16	127	36
SP-C6-650-3350PG	132	650	1500	3350	220	6	4 x M16	127	84
SP-C10-650-4060PG01	132	650	1473	4060	225	10	4 x M16	127	85
SP-C10-650-5050PG01	132	650	1473	5050	265	10	4 x M16	127	90
SP-C12.5-650-3350PG01	132	650	1473	3350	225	12.5	4 x M16	127	84
SP-C13-1050-5910PG01	220	1050	2210	5910	265	13	4 x M16	127	225
SP-C20-1050-7380PG	220	1050	2300	7380	325	20	4 x M16 8 x 18mm	127 254	280
SP-C8-1050-7595PG	220	1050	2300	7595	302	8	8 x 18mm 8 x 18mm	254 325	225
SP-C18-1300-11750PG01	375	1300	3450	11750	365	18	4 x M16 8 x 18mm	127 254	500
SP-C10-1550-9500PG	500	1550	3350	9500	345	10	4 x M16 8 x 18mm	127 300	475
SP-C12.5-1550-11800PG	500	1550	3350	11800	375	12.5	4 x M16 8 x 18mm	127 325	575

For other designs or for custom-made products please contact your local TE sales engineer.

TE Composite Station Post Insulator Range

Catalogue Reference	Nominal System Voltage (kV)	Lightning Impulse Withstand Voltage (kV)	Height (mm)	Nominal Creepage (mm)	Largest Shed Dia (mm)	Bending Strength (kN)	Fixing Arrangements		Approx Weight (kg)
							Thread	PCD (mm)	
SP-C4-150-600-CSG	22	150	305	600	120	4	4 x M12	76	2
SP-C12.5-150-768CER	22	150	305	768	122	12.5	4 x M12	76	5
SP-C10-150-705CER	22	150	375	705	122	10	4 x M12	66	3
SP-C10-150-883CER	22	150	415	883	122	10	4 x M12	66	3
SP-C10-170-1000CER	33	170	455	1000	122	10	4 x M12	66	4
SP-C12.5-170-1072CER	33	170	445	1072	122	12.5	4 x M12	76	4
SP-C10-170-1180CER	33	170	495	1180	122	10	4 x M12	66	4
SP-C10-170-1160CER	33	170	500	1160	122	10	4 x M12	66	4
SP-C6-250-1370-CSG	33	250	560	1370	152	6	4 x M12	76	5
SP-C6-325-2000-CSG	66	325	770	2000	216	6	4 x M16	127	16
SP-C8-325-1815-CSG	66	325	770	1815	216	8	4 x M16	127	17
SP-C8-325-2250-CSG	66	325	770	2250	216	8	4 x M16	127	17
SP-C10-450-2715-CSG	110	450	1020	2715	216	10	4 x M16	127	18
SP-C8-550-3075-CSG	132	550	1220	3075	232	8	4 x M16	127	18
SP-C8-550-3710-CSG	132	550	1220	3710	232	8	4 x M16	127	18
SP-C6-650-4266CPG	132	650	1500	4266	160	6	4 x M16	127	22
SP-C12.5-650-3625-CSG	132	650	1500	3625	232	12.5	4 x M16	127	36
SP-C16-950-6125-CSG	220	950	2100	6125	270	16	4 x M16 8 x 18mm	127 300	75
SP-C12.5-1050-9150-CSG	220	1050	2310	9150	270	12.5	4 x M16 8 x 18mm	127 275	70
SP-C12.5-1300-12680-CSG	375	1300	3165	12680	270	12.5	4 x M16 4 x 18mm	127 300	85
SP-C8-1550-9700-CSG	500	1550	3340	9700	235	8	4 x M16 4 x 18mm	127 275	85

For other designs or for custom-made products please contact your local TE sales engineer.

TE NAMING CONVENTIONS

SP-Cxxx-yyyy-zzzzMMFnn

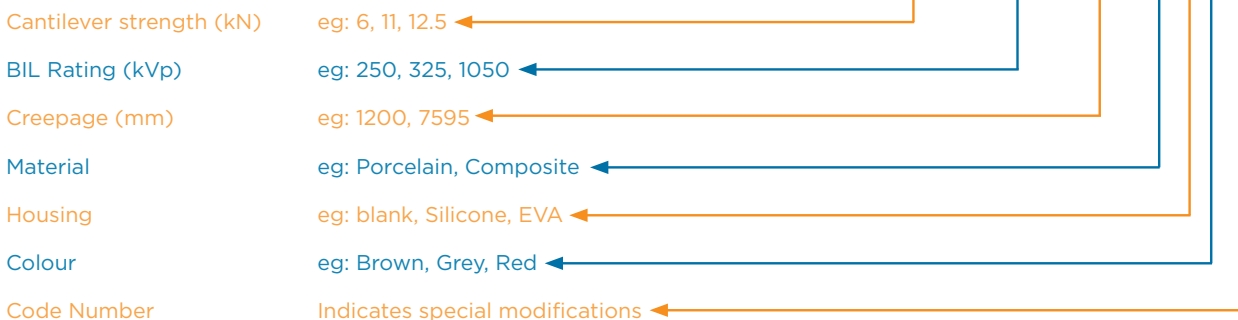





SECTION 2 LINE POST INSULATORS

Specifying Line Post Insulators	14
Designation of Line Post Insulators	14
Standard End Fittings	15
Standard Tolerances.....	16
Porcelain.....	17
Composite	18
Hybrid.....	19

Specifying Line

Post Insulators

To specify the correct line post insulator, it is necessary to define the following characteristics:

- Cantilever (bending) failure load [kN]
- Lightning Impulse Withstand Voltage (BIL) - dry [kV]
- Nominal Creepage Distance [mm]
- Fixing Arrangements for line-end and ground-end
- Colour
- Height (if required) [mm]

DESIGNATION OF STATION POST INSULATORS

In accordance with AS 2947.2, standard line post insulators are assigned a reference designation which indicates:

- Insulator type
- Mechanical strength
- Fitting type
- Line-end fixing description
- Lightning impulse withstand voltage

- Creepage distance class

Example: R 12.5 ET 325 N

where

R = line post insulator

12.5 = 12.5kN mechanical bending strength

E = external fittings

T = tie top

325 = 325kV BIL (lightning impulse withstand voltage)

N = normal creepage distance in accordance with AS 2947.2

CALCULATING CREEPAGE DISTANCE

Refer to the Creepage Distance Table in Appendix A



Insulators

Quick Reference Guide

Standard End Fittings

Fittings are manufactured with malleable cast iron or spheroidal graphite cast iron, and are hot-dip galvanised to comply with the requirements of AS 4680 with an average zinc coating exceeding 600g/m² (equivalent to a thickness of 85µm).

LINE END FITTINGS

Tie Top (T)

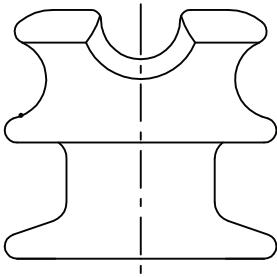

Clamp Top (C)

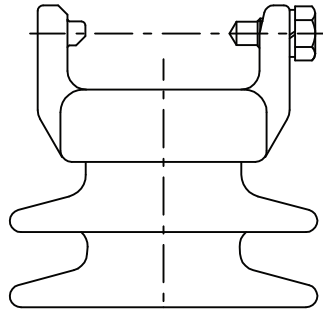

Horizontal Clamp Top (H)

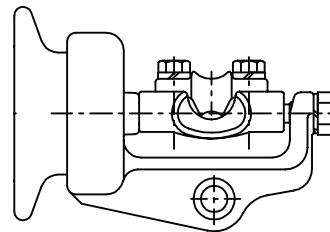

GROUND END FITTINGS

X-Arm

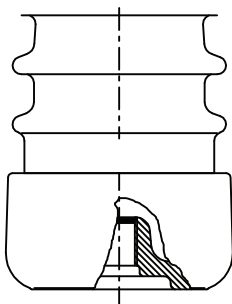

Pin Post (01)

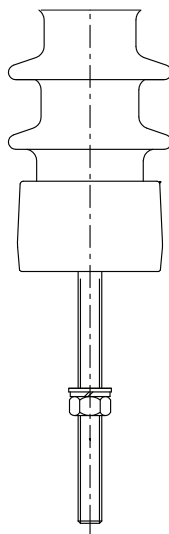

Gain Base (02)

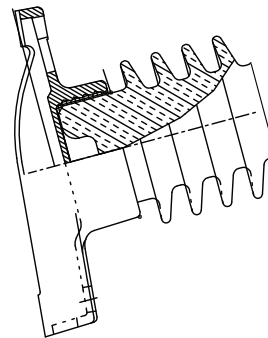

Flat Base (04)

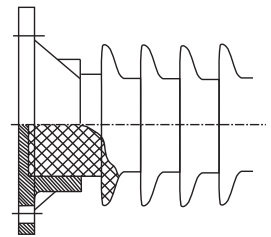

Standard Tolerances

DIMENSIONS FOR WHICH NO SPECIAL TOLERANCE IS SPECIFIED:

$\pm (0.04 d + 1.5)$ mm when $d \leq 300$

$\pm (0.025 d + 6)$ mm when $d > 300$

where d is the checked dimension in millimetres.

CREEPAGE DISTANCE:

$\pm (0.04 d + 1.5)$ mm

where d is the creepage distance in millimetres.

TIE TOP:

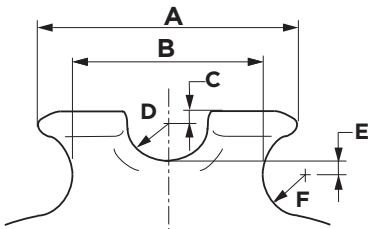

Head Type	Dimension (mm)					
	A	B	C	D	E	F
AS 2947.2 Standard Head	102	76±5	4	R16	8±3	R16
IEC 60720 Standard Head	124	73±3	-	R25	18±4	R25
IEC 60720 Alternative Head	170	152±3	-	40±5	18±4	19 min
ANSI C29.7 A-Neck	-	44±3	-	-	18±4	-
ANSI C29.7 C-Neck	-	57±3	-	-	18±4	-
ANSI C29.7 F-Neck	124	73±3	-	R25	18±4	R25
ANSI C29.7 N-Neck	-	152±3	-	38	18±4	19 min

CLAMP TOP:

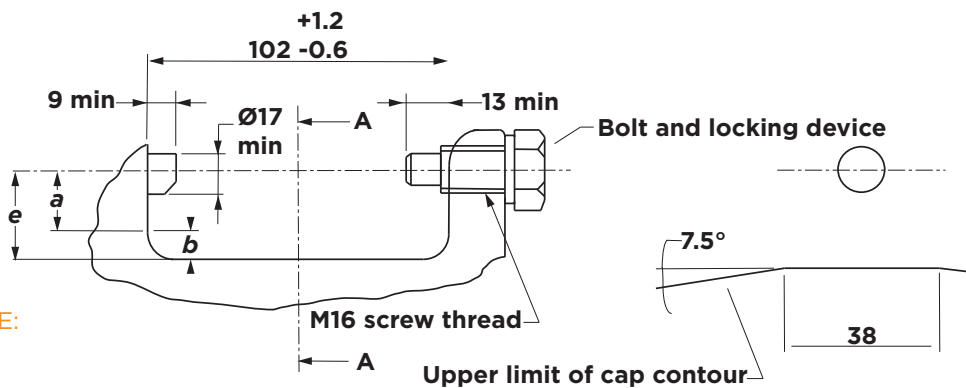

CROSS ARM BASE:

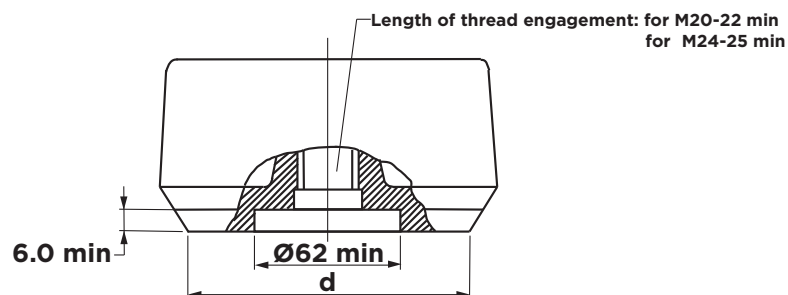

Insulators

Quick Reference Guide

TE Porcelain Line Post Insulator Range

Catalogue Reference	Nominal System Voltage (kV)	Lightning Impulse Withstand Voltage (kV)	Height (mm)	Nominal Creepage (mm)	Cantilever Strength (kN)	Ground End	Line End	Approx Weight (kg)
LP-R7ET105-275PG01	11	105	276	275	7	Pin Post	T	5
LP-R18ET150-452PG03	22	150	286	452	18	X-Arm	T	10
LP-R11ET150-575PG	22	150	318	575	11	X-Arm	T	11
LP-R11ET150-480PG01	22	150	365	480	11	Pin Post	T	9
LP-R7EH150-530PG01	22	150	411	530	7	Pin Post	H	9
LP-R12EH150-460PG03	22	150	352	460	12	X-Arm	H	12
LP-R11ET150-610PG	22	150	487	610	11	X-Arm	T	16
LP-R11EH150-634PG	22	150	560	634	11	X-Arm	H	20
LP-R11ET200-610PG	22/33	200	487	610	11	X-Arm	T	16
LP-R12.5ET200-920PG	33	200	487	920	12.5	X-Arm	T	16
LP-R11EC200-825PG	33	200	530	825	11	X-Arm	C	20
LP-R11EH200-825PG	33	200	560	825	11	X-Arm	H	20
LP-R11ET250-1300PG	44/66	250	532	1300	11	X-Arm	T	19
LP-R12.5EH250-1295PG02	44/66	250	598	1295	12.5	Gain Base	H	31
LP-R11EH350-1300PG	66	350	810	1300	11	X-Arm	H	30
LP-R12.5ET350-1510PG	66	350	752	1510	12.5	X-Arm	T	25
LP-R12.5EH350-1830PG04	66	350	928	1830	12.5	Flat Base	H	46
LP-R12.5ET350-1900PG	66	350	784	1900	12.5	X-Arm	T	33
LP-R12.5EC350-1920PG	66	350	820	1920	12.5	X-Arm	C	35
LP-R12.5EH350-1920PG	66	350	848	1920	12.5	X-Arm	H	35
LP-R12.5EH350-1920PG02	66	350	829	1920	12.5	Gain Base	H	42

For other designs or for custom-made products please contact your local TE sales engineer.

TE NAMING CONVENTIONS

LP-Rxxx-ETyyyy-zzzzMMFnn

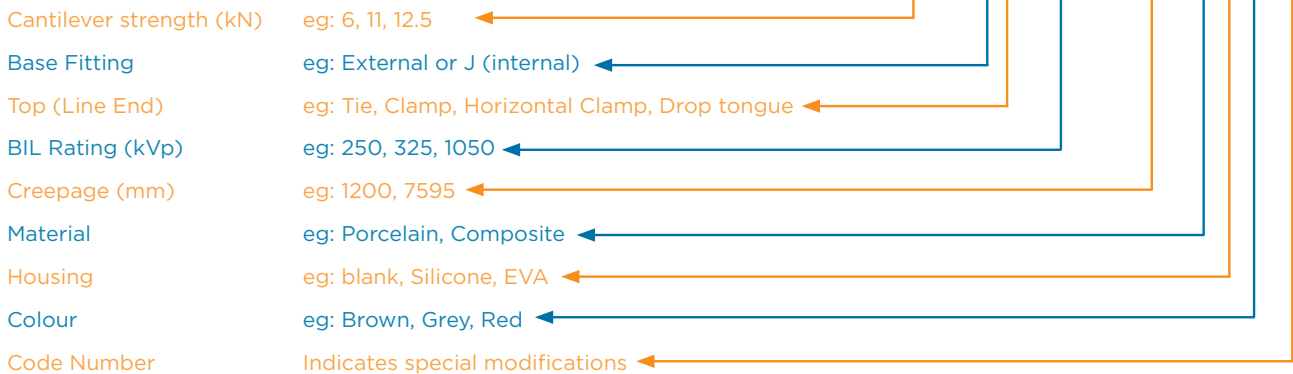

TE Composite Line Post Insulator Range

Catalogue Reference	Nominal System Voltage (kV)	Lightning Impulse Withstand Voltage (kV)	Height (mm)	Nominal Creepage (mm)	Cantilever Strength (kN)	Ground End	Line End	Approx Weight (kg)
LP-R11ET125-686CSG	22	125	300	686	11	X-Arm	T	2
LP-R11EH125-960CSG	22	125	561	960	11	X-Arm	H	5
LP-R11ET145-726CSG	22	145	376	726	11	X-Arm	T	3
LP-R11ET145-1125CSG	22	145	423	1125	11	X-Arm	T	4
LP-R11EC145-960CSG	22	145	560	960	11	X-Arm	C	5
LP-R12.5ET200-1074CER	33	200	455	1074	12.5	X-Arm	T	4
LP-R12.5ET200-1224CSG	33	200	500	1224	12.5	X-Arm	T	4
LP-R12.5EC244-1074CER	33	244	469	1074	12.5	X-Arm	C	5
LP-R12.5EH244-1074CER	33	244	490	1074	12.5	X-Arm	H	5
LP-R11EH370-1958CSG02	66	370	889	1958	11	Gain Base	H	21
LP-R9EH430-2354CSG03	66	430	966	2354	9	Flange	H	16
LP-R6EH640-3700CSG05	132	640	1421	3700	6	Bend. Gain Base	H	33
LP-R7EH650-3736CSG03	132	650	1389	3736	7	Flange	H	22
LP-R7EH650-3700CSG02	132	650	1417	3700	7	Gain Base	H	28
LP-R10EH650-5250CSG02	132	650	1700	5250	10	Gain Base	H	18
LP-R6ED655-3472CSG02	132	655	1367	3472	6	Gain Base	D	20

For other designs or for custom-made products please contact your local TE sales engineer.

STANDARD END FITTINGS

LINE END FITTINGS

Tie Top (T)

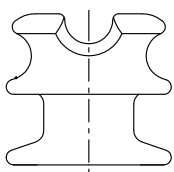

Clamp Top (C)

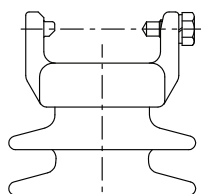

Horizontal Clamp Top (H)

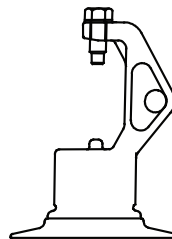

Drop Tongue (D)

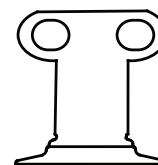

GROUND END FITTINGS

X-Arm

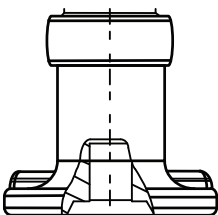

Flange (03)

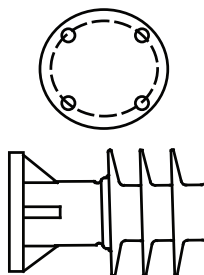

Gain Base (02)

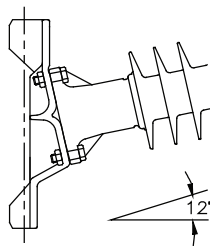

Bendable Gain Base (05)

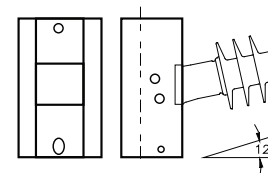

Insulators

Quick Reference Guide

TE Hybrid Line Post Insulator Range

Catalogue Reference	Nominal System Voltage (kV)	Lightning Impulse Withstand Voltage (kV)	Height (mm)	Nominal Creepage (mm)	Cantilever Strength (kN)	Ground End	Line End	Approx Weight (kg)
LP-R12.5ET125-540PSR	11	125	290	540	12.5	X-Arm	T	4
LP-R12.5ET145-646PSR	22	145	330	646	12.5	X-Arm	T	5

For other designs or for custom-made products please contact your local TE sales engineer.

FIXING ARRANGEMENT OPTIONS

M20 + 0.25 o/s Also available with short or long stud.

O1 supplied with 48mm stud

O2 supplied with 190mm stud

STANDARD END FITTINGS

Line End Fittings

Tie Top (T)

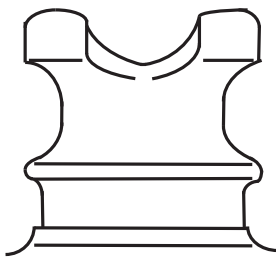

Ground End Fittings

X-Arm

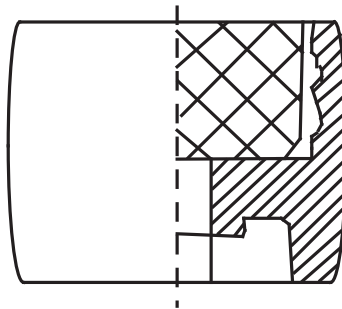

FEATURES AND BENEFITS OF HYBRID INSULATORS

Hybrid line post insulators suit applications with system voltages up to 25 kV in highly polluted environments. They combine the best features of porcelain and polymer whereby a ceramic core provides mechanical strength and rigidity while a polymeric housing offers considerable weight reduction and superior electrical performance. The unique design generates huge reductions in leakage current and consequently provides considerable cost-savings due to reduced power loss. Hybrid insulators are the solution for any utility seriously concerned about green energy.





SECTION 3 STRING INSULATOR UNITS

Specifying Disc Insulators.....	22
Designation of Disc Insulators	22
Standard Tolerances	22
Electrical Properties of Insulator Strings	23
Porcelain and Glass Discs	24
Specifying Composite Longrod Insulators.....	25
Designation of Composite Longrod Insulators.....	25
Standard Tolerances	25
Composite Longrods - Distribution.....	26
Composite Longrods - Transmission.....	27

Specifying Disc Insulators

To specify the correct disc insulator, it is necessary to define the following characteristics:

- Electromechanical failure load [kN]
- Maximum diameter of the insulating component [mm]
- Pitch (unit spacing) [mm]
- Nominal Creepage Distance [mm]
- Coupling and type of retaining clip
- Material (porcelain or glass)
- Colour (required when the material is porcelain)

DESIGNATION OF DISC INSULATORS

In accordance with AS 2947.2, standard disc insulators are assigned a reference designation which indicates:

- Insulator type
- Mechanical strength
- Coupling type
- Pitch category (Long, Short, or undefined)
- Creepage distance class (suffixes for high pollution only)

Example: U 70 BLP

where

U = cap and pin disc insulator

70 = 70kN mechanical tensile strength

B = ball & socket couplings

L = long pitch

P = high creepage distance for polluted areas

STANDARD TOLERANCES (WHERE ALL DIMENSIONS ARE GIVEN IN MILLIMETRES)

Dimensions for which no special tolerance is specified:

$\pm (0.04 d + 1.5)$ mm when $d \leq 300$

$\pm (0.025 d + 6)$ mm when $d > 300$

Pitch:

$\pm (0.04 P + 0.3)$ mm

where P is the pitch (nominal spacing) in millimetres.



Electrical Properties of Insulator Strings

When coupled together in strings, the electrical properties of discs cannot simply be added together in a linear fashion. Based on empirical data, the following table provides an example of how several key properties change as string length increases.

No of units in string	Diameter 255 / Pitch 146 (Standard)				Diameter 330 / Pitch 170 (Antifog)			
	Total Length	Power Frequency withstand (kV)		BIL (kV)	Total Length	Power Frequency withstand (kV)		BIL (kV)
		Dry	Wet			Dry	Wet	
1	146	70	40	100	170	90	55	140
2	292	130	75	195	340	150	105	235
3	438	180	115	275	510	210	150	335
4	584	235	155	360	680	265	190	435
5	730	280	195	430	850	320	230	535
6	876	325	230	505	1020	370	270	625
7	1022	375	265	580	1190	420	300	710
8	1168	420	300	660	1360	470	335	800
9	1314	465	325	730	1530	515	365	890
10	1460	510	375	800	1700	570	395	980
11	1606	550	410	880	1870	610	430	1070
12	1752	595	440	955	2040	660	460	1170
13	1898	635	475	1025	2210	700	490	1260
14	2044	675	510	1095	2380	745	520	1355
15	2190	715	540	1160	2550	785	550	1450
16	2336	755	570	1230	2720	830	575	1540
17	2482	800	600	1300	2890	870	605	1640
18	2628	855	635	1370	3060	910	630	1730
19	2774	875	665	1440	3230	950	655	1810
20	2920	915	700	1510	3400	990	680	1900
21	3066	950	730	1575	3570	1030	700	1990

Ball & Socket (B&S)

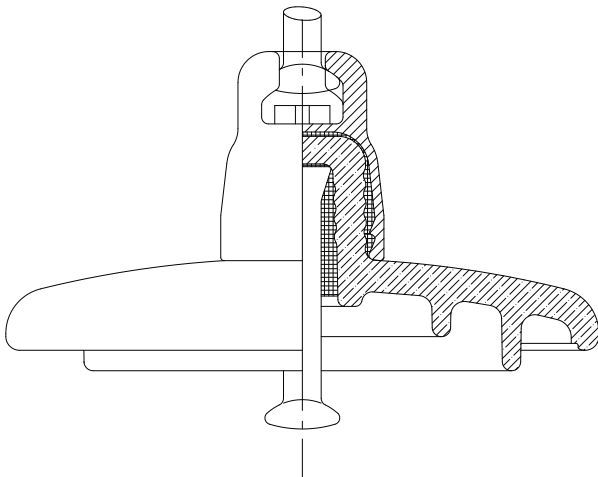

Tongue & Clevis (T&C)

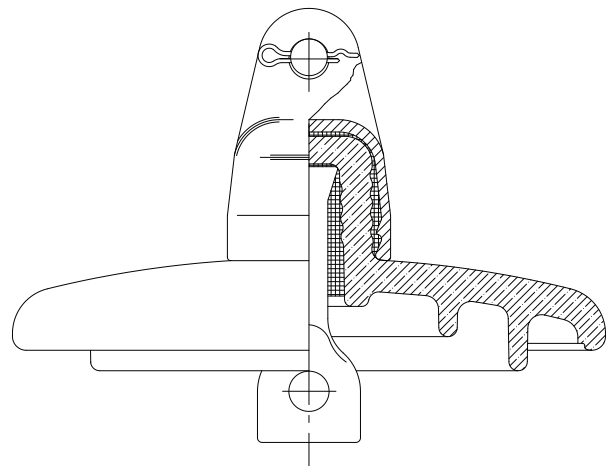

TE Porcelain and Glass Disc Range

Catalogue Reference	Mechanical Failing Load (kN)	Maximum Nominal Diameter (mm)	Pitch (mm)	Nominal Creepage (mm)	Couplings	Coupling Size to	Retaining Clip / Coupling Pin	Approx Weight (kg)	Zinc Collar
DI-U70C292-PG	70	255	146	292	T&C	16C	Round	4	Yes
DI-U70C292-PGH	70	255	146	292	T&C	16C	Hex	4	No
DI-U70BL295-PBW	70	255	146	295	B&S	16B	W	4	No
DI-U70BL320-GVZW	70	255	146	320	B&S	16B	W	4	Yes
DI-U70C320-GV	70	255	146	320	T&C	16C	Round	4	No
DI-U70C320-GVZ	70	255	146	320	T&C	16C	Round	4	Yes
DI-U70BL400-GVZR	70	255	146	400	B&S	16B	R	5	Yes
DI-U80BL320-GVW	80	255	146	320	B&S	16B	W	4	No
DI-U80BL320-GVZW	80	255	146	320	B&S	16B	W	4	Yes
DI-U80BL390-GVZW	80	255	146	390	B&S	16B	W	5	Yes
DI-U100BL390-GVZR	100	255	146	390	B&S	16A	R	5	Yes
DI-U120BL292-PGW	120	255	146	292	B&S	16B	W	5	No
DI-U120BL320-GVZR	120	255	146	320	B&S	20	R	4	Yes
DI-U125BS320-GVZW	125	255	146	320	B&S	20	W	4	Yes
DI-U160BS305-PGW	160	280	146	305	B&S	20	W	8	No
DI-U160BS440-PGZR	160	280	146	440	B&S	20	R	9	Yes
DI-U160BS445-GVZW	160	280	146	445	B&S	16B	W	6	Yes
DI-U160BS570-PBZR	160	330	146	570	B&S	20	R	12	Yes
DI-U190B550-GVZW	190	330	170	550	B&S	24	W	10	Yes
DI-U210BS370-PBZR	210	300	170	370	B&S	20	R	12	Yes
DI-U210BS450-PBZR	210	330	170	450	B&S	20	R	16	Yes
DI-U300BP505-PGZR	300	400	195	505	B&S	24	R	20	Yes

For other designs or for custom-made products please contact your local TE sales engineer.

TE NAMING CONVENTIONS

DI-Uxxx-B L zzz-M F n Z c

- Tensile Rating (kN) eg: 70, 120, 160
- Fittings eg: Ball & Socket, Clevis & Tongue
- Pitch eg: Long, Short, or blank
- Creepage (mm) eg: 292, 320, 540
- Material eg: Porcelain, Glass
- Colour eg: Brown, Grey, V (Green)
- Code Number Indicates special modifications
- Zinc collar Z = Zinc collar included; blank = no Zinc collar
- Retaining Clip eg: W or R

Insulators

Quick Reference Guide

Specifying Composite Longrod Insulators

To specify the correct longrod insulator, it is necessary to define the following characteristics:

- Specified mechanical load (SML) [kN]
- Pitch (unit spacing) [mm]
- Nominal Creepage Distance [mm]
- Couplings
- Housing Material

DESIGNATION OF COMPOSITE LONGROD INSULATORS

In accordance with AS 4435.2, composite longrod insulators are assigned a reference designation which indicates:

- Insulator type
- Mechanical strength
- Coupling type

Example: CS 70 S16 B16

where

CS = composite longrod insulator

70 = 70kN specified mechanical load (tension)

S16 = top end Socket coupling according to IEC 120, size 16

B16 = bottom end Ball coupling according to IEC 120, size 16

STANDARD TOLERANCES (WHERE ALL DIMENSIONS ARE GIVEN IN MILLIMETRES)

Dimensions for which no special tolerance is specified:

$$\pm (0.04 d + 1.5) \text{ mm when } d \leq 300$$

$$\pm (0.025 d + 6) \text{ mm when } d > 300$$



ADDITIONAL DESIGNATION LETTERS FOR COUPLINGS:

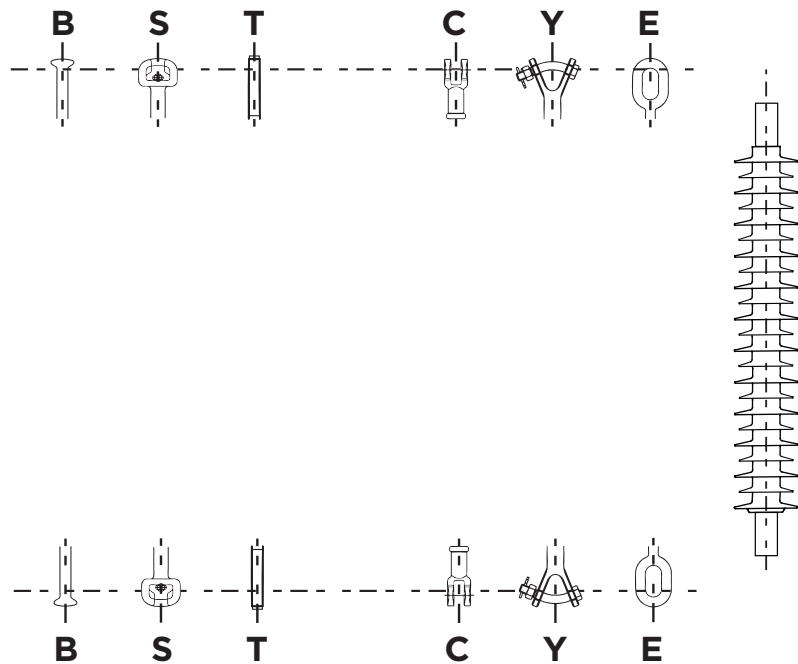

TE Composite Longrods Range - for Distribution

Catalogue Reference	Nominal System Voltage (kV)	Lightning Impulse Withstand Voltage (kV)	Pitch (mm)	Dry Arcing Distance (mm)	Nominal Creepage (mm)	Specific Creepage (mm / kV)	Couplings	Approx Weight (kg)	No of Sheds
LR-CS70SB95-420CSG	11	95	325	189	420	35	SB	1.2	4
LR-CS70SB155-658CSG	22	155	415	252	658	27	SB	1.4	6
LR-CS70SB160-760CSG	22	160	450	307	760	32	SB	1.4	7
LR-CS70SB180-857CSG	22	180	475	335	857	36	SB	1.5	8
LR-CS70SB190-950CSG	33	190	500	360	950	26	SB	1.6	9
LR-CS70SB210-1076CSG	33	210	555	416	1076	30	SB	1.6	10
LR-CS70SB235-1177CSG	33	235	590	450	1177	33	SB	1.7	11
LR-CS70SB350-1870CSG	66	350	880	750	1870	26	SB	2.4	9 + 16
LR-CS70SB350-2408CSG	66	350	880	780	2408	33	SB	3.2	9 + 16
LR-CS70CT95-420CSG	11	95	325	189	420	35	CT	1.2	4
LR-CS70CT155-658CSG	22	155	415	252	658	27	CT	1.4	6
LR-CS70CT160-760CSG	22	160	450	307	760	32	CT	1.4	7
LR-CS70CT180-857CSG	22	180	475	335	857	36	CT	1.5	8
LR-CS70CT190-950CSG	33	190	500	360	950	26	CT	1.6	9
LR-CS70CT210-1076CSG	33	210	555	416	1076	30	CT	1.6	10
LR-CS70CT235-1177CSG	33	235	590	450	1177	33	CT	1.7	11
LR-CS70CT350-1870CSG	66	350	880	750	1870	26	CT	2.4	9 + 16
LR-CS70CT350-2408CSG	66	350	880	780	2408	33	CT	3.2	9 + 16

For other designs or for custom-made products please contact your local TE sales engineer.

TE NAMING CONVENTIONS

LR-CSxxxTByyyy-zzzzMMFnn

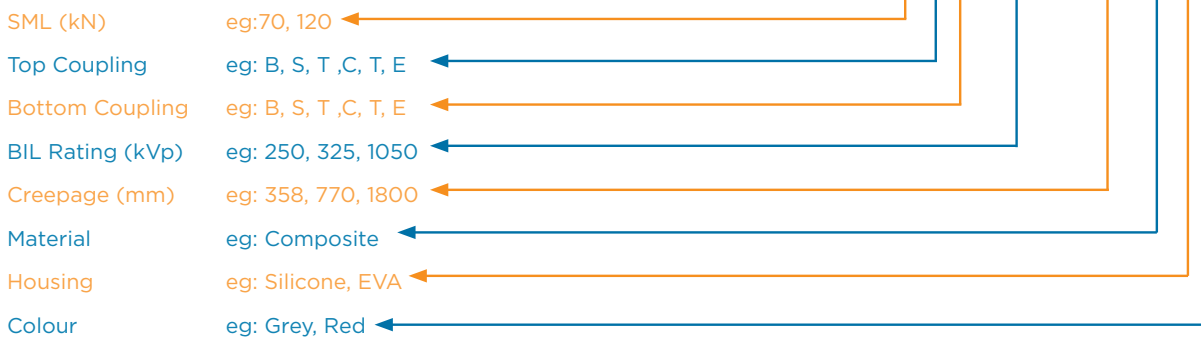

TE Composite Longrods Range - for Transmission

Catalogue Reference	Nominal System Voltage (kV)	Lightning Impulse Withstand Voltage (kV)	Pitch (mm)	Dry Arcing Distance (mm)	Nominal Creepage (mm)	Specific Creepage (mm / kV)	Couplings	Approx Weight (kg)	No of Sheds
LR-CS70CT340-1822CSG	66	340	749	616	1822	70	CT	3	21
LR-CS120EY360-1800CSG	66	360	892	601	1800	120	EY	4	21
LR-CS160EE360-1800CSG	66	360	903	601	1800	160	EE	4	21
LR-CS120YB390-1935CSG	66	390	924	656	1935	120	YB	4	23
LR-CS70SB390-1937CSG	66	390	779	671	1937	70	SB	3	23
LR-CS70SB425-2118CSG	66	425	834	726	2118	70	SB	3	25
LR-CS70SB430-1960CSG	66	430	755	717	1960	70	SB	3	21
LR-CS70SB485-2446CSG	66	485	944	836	2446	70	SB	4	29
LR-CS160SB685-3641CSG	132	685	1474	1206	3641	160	SB	7	43
LR-CS70SB690-3629CSG	132	690	1337	1213	3629	70	SB	5	43
LR-CS120EY690-3641CSG	132	690	1484	1206	3641	120	EY	6	43
LR-CS120YE690-3641CSG	132	690	1497	1206	3641	120	YE	6	43
LR-CS160EB690-3641CSG	132	690	1466	1135	3641	160	EB	8	43
LR-CS120SB690-3735CSG	132	690	1439	1206	3735	120	SB	6	43
LR-CS160SB750-3982CSG	132	750	1584	1316	3982	160	SB	7	47
LR-CS70SB750-3988CSG	132	750	1447	1323	3988	70	SB	5	47
LR-CS160SB1075-5829CSG	275	1075	2189	1850	5829	160	SB	11	69
LR-CS160SB1310-7187CSG	400	1310	2629	2219	7187	160	SB	15	85

For other designs or for custom-made products please contact your local TE sales engineer.

Insulators are available either with or without grading rings.





SECTION 4 PIN INSULATORS

Specifying Pin Insulators	30
Designation of Pin Insulators.....	30
Standard Tolerances	30
Standard Characteristics for Pin Insulators.....	31
Head Types.....	32
Pin Types	33
Pin Head Patterns	33
Pin Insulators	34
Pins	34

Specifying Pin Insulators

To specify the correct pin insulator, it is necessary to define the following characteristics:

- Cantilever (bending) failure load [kN]
- Lightning Impulse Withstand Voltage (BIL) – dry [kV]
- Shed Profile
- Nominal Creepage Distance [mm]
- Thread Pattern
- Tie-top Head Dimensions
- Colour

DESIGNATION OF PIN INSULATORS

In accordance with AS 2947.2, pin insulators are assigned a reference designation using a letter and digit code as follows:

1. Three letters, where the first letter represents shed profile, i.e.

S—standard type

F—fog type

A—aerodynamic type

The second and third letters are always 'LP' which represents 'Line Pin'.

2. Two digits representing the typical

operating voltage.

3. Three digits representing the nominal minimum creepage distance in millimetres.

Example: SLP/11/180

where

SLP = Standard Line Pin

11 = 11 kV typical operating voltage

180 = 180 mm nominal minimum creepage distance

STANDARD TOLERANCES (WHERE ALL DIMENSIONS ARE GIVEN IN MILLIMETRES)

Dimensions for which no special tolerance is specified:

$\pm (0.04 d + 1.5)$ mm when $d \leq 300$

$\pm (0.025 d + 6)$ mm when $d > 300$



Insulators

Quick Reference Guide

Standard Characteristics for Pin Insulators

AS 2947.2 specifies the following characteristics for pin insulators

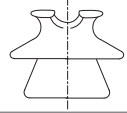
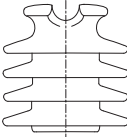
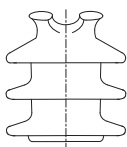
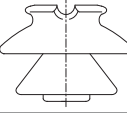
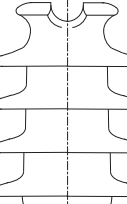
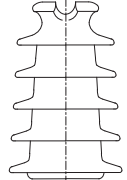
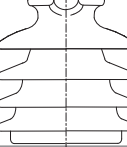
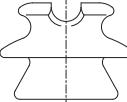
Pin insulator designation	Figure	BIL (kV)	Wet Power Freq w/s (kV)	Nom Min Creepage Distance (mm)	Min Bending Failing Load (kN)	Thread Pattern	Pin Type	Head Type
SLP/11/180		95	28	180	7	A	A/130/7	1
FLP/11/360		95	28	360	7	A	A/130/7	1
ALP/11/275		95	28	275	7	C	C/150/7	1
SLP/22/420		145	50	420	11	C	C/200/11	2
ALP/22/450		145	50	450	11	C	C/200/11	1
ALP/22/490		145	50	490	11	C	C/200/11	1
ALP/22/520		145	50	520	11	C	C/200/11	1
FLP/22/480		145	50	480	11	C	C/150/11	1

Insulators

Quick Reference Guide

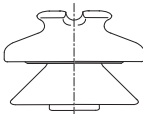
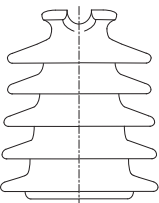
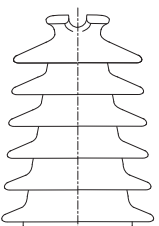
Pin insulator designation	Figure	BIL (kV)	Wet Power Freq w/s (kV)	Nom Min Creepage Distance (mm)	Min Bending Failing Load (kN)	Thread Pattern	Pin Type	Head Type
SLP/33/534		200	70	534	11	C	C/200/7	2
ALP/33/710		200	70	710	7	C	C/300/7	1
ALP/33/920		200	70	920	7	C	C/300/7	1

HEAD TYPES

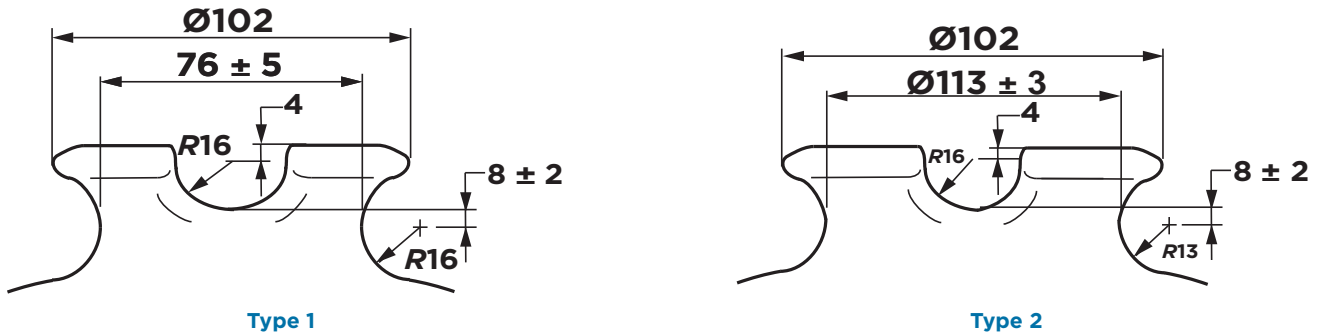

In Australia and New Zealand it is common practice for SLP/11/180 insulators to use a side groove radius of 13 mm

TE NAMING CONVENTIONS

PI-t-LP/w/zzz-MMFn

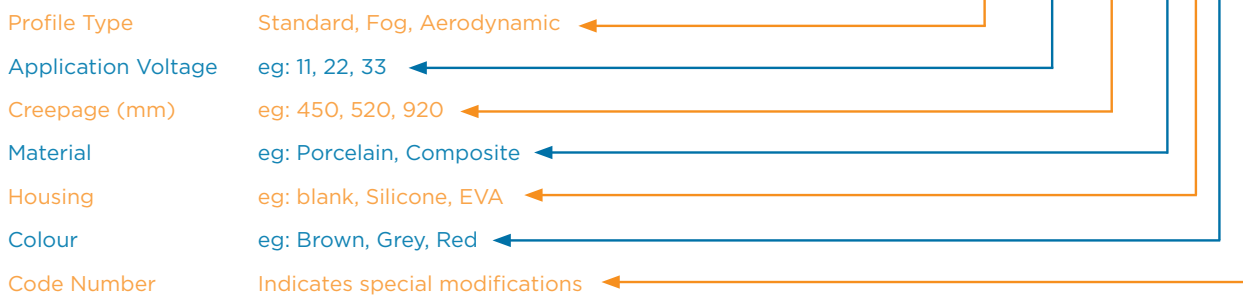

Insulators

Quick Reference Guide

Pin Types

AS 1154.2 PROVIDES THE FOLLOWING DETAILS FOR INSULATORS PIN TYPES:

Pin Type	Min Failing Load	Shank				Collar			Stem			Pin Head Pattern
		Dia	Length	Thread Length	Thread Runout	Min Dia	Depth	Base Dia	Dia	Top Dia	Length	
	(kN)	A	B	C	D	E	F	G	H	I	J	
B/100/3.5	3.5	16	140	50	5	40	6	20	17.3	16	98	B
A/130/7	7	20	165	80	6	50	6	29	22.8	20	128	A
C/150/7	7	20	165	80	6	60	9	30	24.4	20	148	C
C/150/11	11	24	165	80	7	60	9	35	28.9	24	148	C
C/200/11	11	24	165	80	7	65	9	38	28.6	24	198	C
C/300/7	7	24	165	80	7	75	9	37	26.8	24	298	C

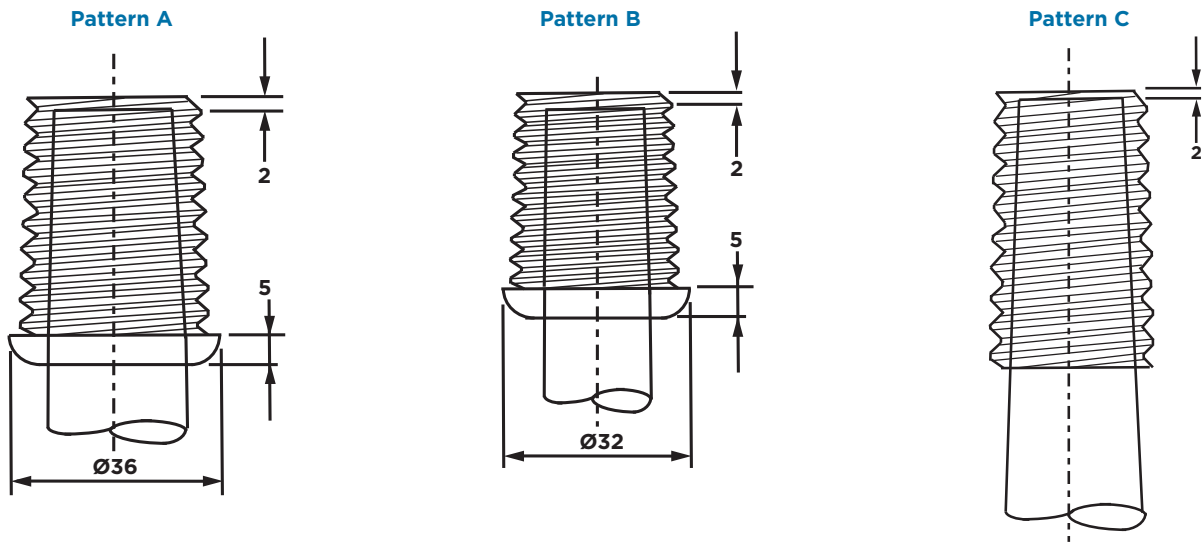

Pin Head Patterns

Refer to AS 2947.3 for details of gauges used for checking each thread pattern. The dimensions (in millimetres) of these gauges are as follows:	Designation			
	Tolerance	Pattern A	Pattern B	Pattern C
Axial length C	±0.05	39.7	32.55	63.5
Thread pitch along taper, P	±0.003/mm	4.233	3.629	6.35
Pitch diameter at gauge plane (see note)	±0.03	28.72	24.84	35.24
Major diameter at gauge plane (see note)	±0.003-0.000	30.92	26.64	36.83
Taper per mm on diameter	±0.02	0.06	0.0976	
V thread truncation at major diameter T1		0.62	0.58	
V thread truncation at minor diameter T2		0.30 max	0.30 max	
Round thread height, HR	±0.02			1.59
Round thread radius, R	±0.02			1.98
Deep limit (1/2 pitch), E	±0.05	2.1	1.8	3.2
Shallow limit (2 pitches) F	±0.05	8.45	7.25	12.7

TE Pin Insulators and Insulator Pin Range

Catalogue Reference	Nominal System Voltage (kV)	Lightning Impulse Withstand Voltage (kV)	Height (mm)	Nominal Creepage (mm)	Cantilever Strength (kN)	Pin Type	Head Type
PI-SLP/11/180-PG	11	95	106	180	7	A/130/7	1
PI-ALP/11/275-PG	11	95	165	275	7	C/150/7	1
PI-SLP/22/420-PG	22	150	168	420	11	C/150/11	2
PI-ALP/22/450-PG	22	150	200	450	11	C/200/11	1
PI-ALP/22/490-PG	22	150	240	490	11	C/200/11	1
PI-ALP/22/520-PG	22	150	215	520	11	C/200/11	1
PI-SLP/33/534-PG	33	170	194	534	11	C/200/11	2
PI-SLP/33/710-PG	33	220	265	710	7	C/300/7	1
PI-ALP/33/920-PG	33	220	320	920	7	C/300/7	1

Standard Pins	Min Failing Load (kN)	Shank			Stem	Pin Head Pattern
		Diameter A	Length B	Thread Length min C	Length J	
IP-B-100-3.5-140-M16	3.5	16	140	50	98	B
IP-A-130-7-165-M20	7	20	165	80	128	A
IP-C-150-7-165-M20	7	20	165	80	148	C
IP-C-150-11-165-M24	11	24	165	80	148	C
IP-C-200-11-165-M24	11	24	165	80	198	C
IP-C-300-7-160-M24	7	24	165	80	298	C

Special Pins	Min Failing Load (kN)	Shank			Stem	Pin Head Pattern
		Diameter A	Length B	Thread Length min C	Length J	
IP-B-100-3.5-165-M16	3.5	16	165	70	98	B
IP-A-130-7-200-M20	7	20	200	100	128	A
IP-C-150-7-200-M20	7	20	200	100	148	C
IP-C-200-11-200-M24	11	24	200	100	198	C

For other designs or for custom-made products please contact your local TE sales engineer.





SECTION 5 OTHER INSULATORS

Designation of Railway Insulators	38
Specifying Railway Insulators	38
End Fittings	38
Railway Insulators	39
Specifying Strain Insulators	40
Designation of Strain Insulators	41
Porcelain Strain Insulators	41
Specifying Low Voltage Insulators	42
Standard Tolerances	42
Designation of Low Voltage Insulators	42
Low Voltage Insulators	42
Studs	43
Clamps	43

Designation of Railway Insulators

Insulators for railway applications do not have a separate designation but generally comprise a variety of insulator types already described in this catalogue, including:

- Line posts (with return conductor insulators)
- Station posts
- Longrods (tension and strut)
- Discs
- Pantograph supports

SPECIFYING RAILWAY INSULATORS

To specify the correct railway insulator, it is necessary to define the following characteristics:

- Insulator type
- Mechanical failure load (bending or tensile) [kN]

- Lightning Impulse Withstand Voltage (BIL) – dry [kV]
- Height / length [mm]
- Nominal Creepage Distance [mm]
- Fixing Arrangements for top and bottom end fittings
- Colour
- Material

END FITTINGS

Fittings are manufactured with malleable cast iron or spheroidal graphite cast iron, and are hot-dip galvanised to comply with the requirements of AS 4680 with an average zinc coating exceeding 600g/m² (equivalent to a thickness of 85µm).

Threaded holes are normally tapped 0.4mm oversize to cater for standard bolts which are hot-dip galvanised.

END FITTING DESIGNATIONS FOR STRUT INSULATORS

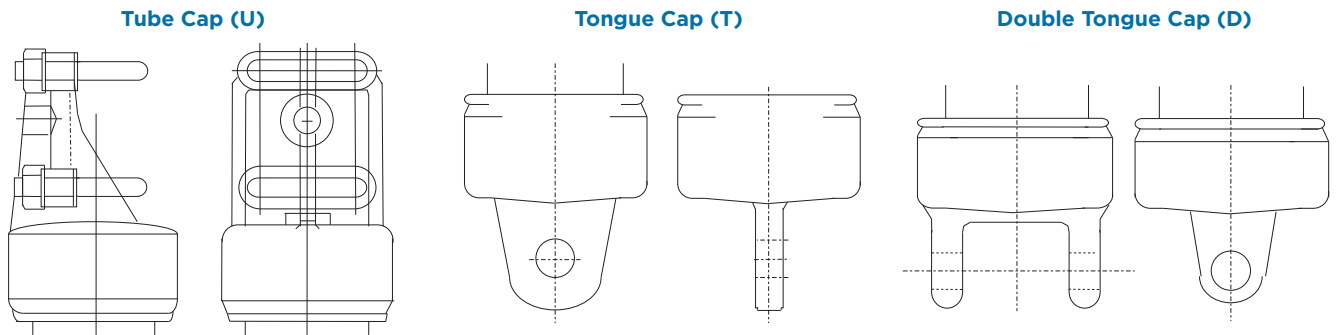

TE NAMING CONVENTIONS

STR - xxx TByyyy-zzzzMMFnn

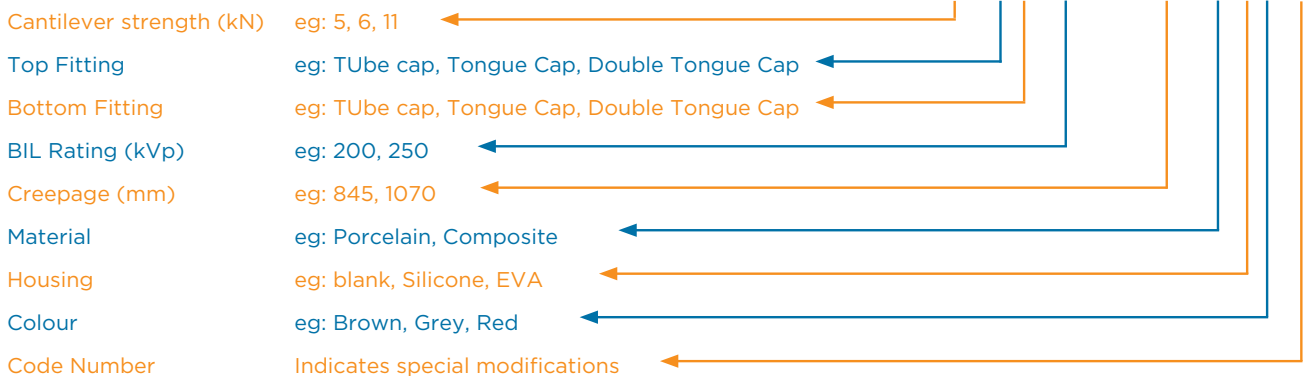

Insulators

Quick Reference Guide

Railway Insulators

RETURN CONDUCTOR INSULATORS

The insulators described in the tables below are available in porcelain, composite and hybrid.

Catalogue Reference	Nominal System Voltage (kV)	Height (mm)	Nominal Creepage (mm)	Largest Shed Dia (mm)	Bending Strength	Fixing Arrangements		Approx Weight (kg)
						Base	Top	
LP-R13ET40-132PG01	5	170	132	185	13	1 x M16	76mm	3
LP-R11ET40-115PG01	5	145	115	180	11	1 x M20	76mm	2

LINE POST INSULATORS

Lightning impulse withstand voltage of 200kV

Catalogue Reference	Nominal System Voltage (kV)	Height (mm)	Nominal Creepage (mm)	Largest Shed Dia (mm)	Bending Strength	Fixing Arrangements		Approx Weight (kg)
						Base	Top	
LP-R5ET200-828PG01	25	470	828	150	5	4 x M12	T	13
LP-R5ET200-1110PG01	33	470	1110	178	5	4 x M12	T	15

STATION POST INSULATORS

Lightning impulse withstand voltage of 200kV

Catalogue Reference	Nominal System Voltage (kV)	Height (mm)	Nominal Creepage (mm)	Largest Shed Dia (mm)	Bending Strength	Fixing Arrangements		Approx Weight (kg)
						Thread	PCD	
SP-C5-200-825PG	25	507	825	150	5	4 x M12	76	15
SP-C5-200-1110PG	33	507	1110	180	5	4 x M12	76	18

STRUT INSULATORS

Lightning impulse withstand voltage of 200kV and above

Catalogue Reference	Nominal System Voltage (kV)	Height (mm)	Nominal Creepage (mm)	Largest Shed Dia (mm)	Bending Strength	Fixing Arrangements		Approx Weight (kg)
						Base	Top	
STR5.4TU200-845PG	25	533	845	166	5.4	U	T	15
STR5.4UT200-845PG	25	533	845	166	5.4	T	U	15
STR3.1DU200-1070PG	25	484	1070	191	3.1	U	D	20
STR5.4TU200-1070PG	25	533	1070	191	5.4	U	T	19
STR6.4UU200-845PG	25	522	845	166	6.4	U	U	18
STR5.3UT200-1070PG	25	533	1070	191	5.3	T	U	19
STR1.5UT200-1100CSG	25	642	1100	130	1.5	Tongue	Tube	-
STROHT200-1072CSG	25	561	1072	155	-	Tongue	Hook	-
STR1UT300-1270CER	25	597	1270	138	1	Tongue	Tube	-
STR1TU300-1270CER	25	597	1270	138	1	Tube	Tongue	-

Insulators

Quick Reference Guide

TE Porcelain Strain Insulators Range

Catalogue Reference	Dimensions (mm)											Min F.L. (kN)
	A	B	C	D	E	F	G	H	I	J	K	
MG-GY2-PG	73	41	44	73	44	146	22	51	22	37	37	71
MG-GY3-PG	115	57	67	115	57	216	38	51	38	63	63	222
MG-GY4-PG	115	57	67	115	57	280	38	51	38	95	95	222



For other designs or for custom-made products please contact your local TE sales engineer.

Dimensions and performance characteristics in accordance with AS3608

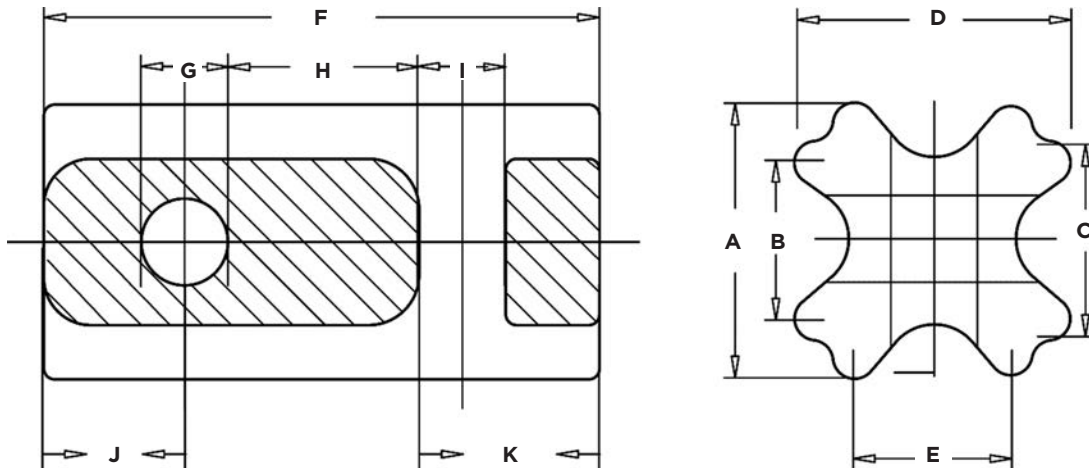

Insulators

Quick Reference Guide

Specifying Low Voltage Insulators

To specify the correct low voltage insulator, it is necessary to define the following characteristics:

- Dimensions in accordance with the drawings shown below
- Mechanical strength [kN]

Dimensions for which no special tolerance is specified:

$$\pm (0.04 d + 1.5) \text{ mm when } d \leq 300$$

where d is the checked dimension in millimetres.

Other tolerances shall be in accordance with the drawings shown in AS 3608.



STANDARD TOLERANCES

DESIGNATION OF LOW VOLTAGE INSULATORS

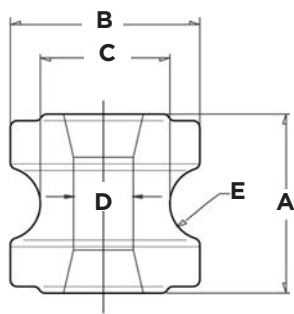

Shackle Type

SHLV1 : SHLV2 : SHLV8

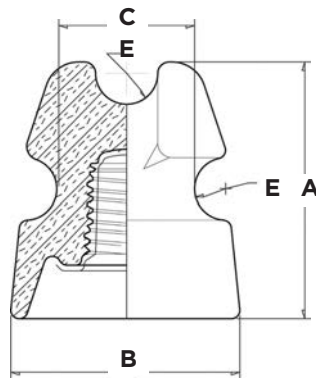

Pin Type

LVLP



LOW VOLTAGE INSULATORS

Catalogue Reference	Dimensions mm					Thread	Pin	Min F.L. (kN)	
	A	Dia. B	Dia. C	Dia. D	Rad. E				
MS-SHLV1-PG	54	57	39	17	⁺² ₋₀	17 min	-	-	9
MS-SHLV2-PG	76	80	54	17	⁺² ₋₀	12 min	-	-	20
MS-SHLV8-PG	32	57	40	17	⁺² ₋₀	7 min	-	-	9
MP-LVLP-PG	91	82	48	⁺² ₋₀	-	11 min	Patt "B"	B/100/3.5	7

Insulators

Quick Reference Guide

TE Porcelain Strain Insulators Range

STUDS

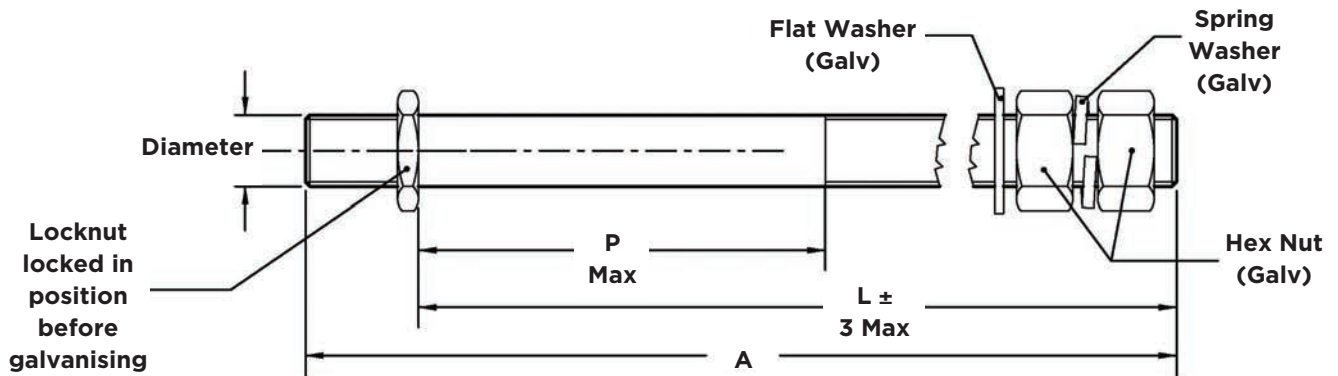

Cat No.	Thread	Overall Length A	Shank Length L	Length P max.	To suit X-arm min.	To suit X-arm max.
IS-11007	M24	239	200	77	71	150
IS-10885	M24	219	180	78	72	130
IS-10886	M24	100	61	5	-	12
IS-10887	M20	239	200	77	71	156

CLAMPS FOR ALUMINIUM AND COPPER CONDUCTORS

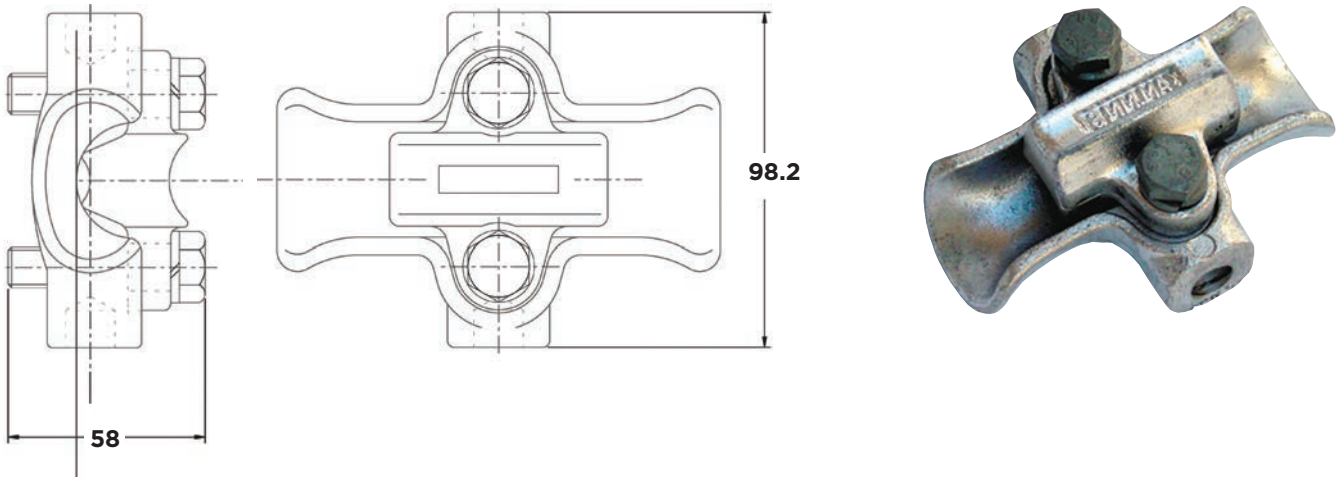

Cat No.		Conductor Dia. mm	
Ferrous	Aluminium	Max.	Min.
	IC-Y11195	32	7
IC-047101	IC-042111	14.2	6.35
IC-047102		21.3	8.89
IC-047103		26.9	12.7
IC-047104	IC-047114	38.1	25.4

Appendix A: Calculating Creepage Distance Table

Common utility practice employs creepage values to match four levels of pollution defined in AS 4436 rather than the creepage classes defined in AS 4398 or AS 2947. Creepage distances for commonly used system voltages are calculated in the table below.

Nominal System Voltage (kV)	Maximum System Voltage (kV)	Creepage Distance (mm) for each Pollution Level			
		Light (16 mm/kV)	Medium (20 mm/kV)	Heavy (25 mm/kV)	Very Heavy (31 mm/kV)
11	12	192	240	300	372
22	24	384	480	600	744
33	36	576	720	900	1116
66	72.5	1160	1450	1813	2248
110	123	1968	2460	3075	3813
132	145	2320	2900	3625	4495
220	245	3920	4900	6125	7595
275	300	4800	6000	7500	9300
330	362	5792	7240	9050	11222
500	550	8800	11000	13750	17050

Appendix B: Installation Tips - Correct Use of Locknuts

A locknut should always be placed as shown.

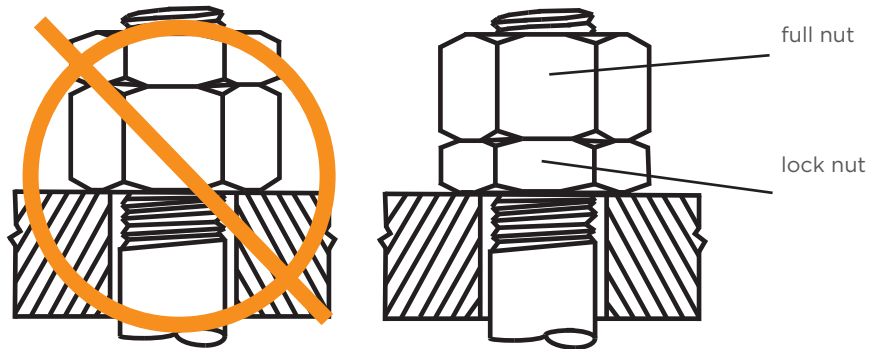

Always assemble the locknut on the bolt first and do it up with only moderate initial torque. Then do up the full nut. As you tighten the full nut, ensure that the locknut is held from turning. While tightening the full nut, the threads of the locknut will first bear upward on the bolt threads, then become free, and finally bear downward on the bolt threads. The threads of the full nut will bear upwards on the bolt threads. Because the two nuts are bearing in opposite directions on the threads they thus become locked. This locking effect will remain even if the bolt tension is lost.

Appendix C: Insulator Selection Chart

For a given height, the insulation performance of a post insulator is a function of its creepage distance, and dry arcing distance, following IEC 60071.

The facing table, based on guidelines from IEC 60071, shows BIL values applicable for common application voltages.

Nominal System Voltage U_n / kV	Maximum Application Voltage U_m / kV	Lightning Impulse Withstand Voltage (kV peak)
11	12	60, 75, 95
22	24	95, 125, 145
33	36	145, 170
66	72.5	325
110	123	450, 550
132	145	550, 650
220	245	850, 950, 1050
275	300	850, 950, 1050
330	362	950, 1050, 1175
380	420	1175, 1300, 1425
480	525	1300, 1425, 1550

Standards Relevant to Insulators

AS 2947	Insulators-Porcelain and glass for overhead power lines-Voltages greater than 1000V AC
	Part 1: Test Methods—Insulator units
	Part 2: Characteristics
	Part 3: Couplings
AS 3608	Part 4: Test Methods-Insulator strings and insulator sets
	Insulators-Porcelain and glass, pin and shackle type-
	Voltages greater than 1000V AC
AS 3609	Insulators-Porcelain stay type-Voltages greater than 1000V AC
AS 4398	Insulators-Ceramic or glass-Station post for indoor and outdoor use-Voltages greater than 1000V AC
	Part 1: Characteristics
	Part 2: Tests
AS 4435	Insulators-Composite for overhead lines-Voltages greater than 1000V AC
	Part 1: Definitions, test methods and acceptance criteria for string insulator units
	Part 2: Standard strength classes and end fittings for string insulator units
	Part 4: Definitions, test methods and acceptance criteria for post insulator units
AS 4436	Guide for the selection of insulators in respect of polluted conditions
AS 4680	Hot-dip galvanised (zinc) coatings on fabricated ferrous articles
AS 4899	Pin insulators-Porcelain and glass for overhead power lines-Voltages greater than 1000V AC
AS 60305	Insulators for overhead lines with a nominal voltage above 1000V-Ceramic or glass insulator units for AC systems-Characteristics of insulator units of the cap and pin type
IEC 60071-1	Insulation Coordination
	Part 1: Definitions, principles and rules

Catalogue Section	Catalogue Reference	Old Catalogue/Drawing Number	Page No
Station Post - Porcelain	SP-C6-95-305PG01	H11656 (4168AX)	9
Station Post - Porcelain	SP-C8-110-400PG	H10903 (4231AX)	9
Station Post - Porcelain	SP-C7-125-607PG	H10841 (4221AX)	9
Station Post - Porcelain	SP-C6-150-630PG	H11103 (4223AX)	9
Station Post - Porcelain	SP-C6-150-750PG	H10747 (4112AX)	9
Station Post - Porcelain	SP-C5-170-760PG01	H10755 (4229AX)	9
Station Post - Porcelain	SP-C4-200-885PG01	H10965 (4232AX)	9
Station Post - Porcelain	SP-C4-200-980PG01	H10843 (4411AX)	9
Station Post - Porcelain	SP-C10-200-995PG01	H10765 (4230AX)	9
Station Post - Porcelain	SP-C9-200-995PG	H11666 (4240AX)	9
Station Post - Porcelain	SP-C6-200-902PG01	H11132 (4280AX)	9
Station Post - Porcelain	SP-C10-250-1200PG	H14009 (4247AX)	9
Station Post - Porcelain	SP-C6-350-1813PG	H11610 (4224AX)	9
Station Post - Porcelain	SP-C8-350-1765PG	H14002	9
Station Post - Porcelain	SP-C6-650-3350PG	4309AX	9
Station Post - Porcelain	SP-C10-650-4060PG01	DA-410061LL	9
Station Post - Porcelain	SP-C10-650-5050PB01	DA-410062LL-BN	9
Station Post - Porcelain	SP-C12.5-650-3350PG01	DA-86350L	9
Station Post - Porcelain	SP-C13-1050-5910PG01	8A-69575MC	9
Station Post - Porcelain	SP-C20-1050-7380PG	8A-120102CF	9
Station Post - Porcelain	SP-C18-1300-11750PB01	8A-69618LE-BN	9
Station Post - Composite	SP-C12.5-150-768CER	PSI-31R-A3S-305	10
Station Post - Composite	SP-C10-150-705CER	PSI-25A	10
Station Post - Composite	SP-C10-150-883CER	PSI-25A-HP	10
Station Post - Composite	SP-C10-170-1000CER	PSI-36A	10
Station Post - Composite	SP-C12.5-170-1072CER	PSI-43R-A3S-445	10
Station Post - Composite	SP-C10-170-1180CER	PSI-36A-HP	10
Station Post - Composite	SP-C10-170-1160CER	PSI-36A-A3.5S	10
Line Post - Porcelain	LP-R7ET105-275PG01	H11536	17
Line Post - Porcelain	LP-R18ET150-452PG03	H11388	17
Line Post - Porcelain	LP-R11ET150-575PG	H11357	17
Line Post - Porcelain	LP-R11ET150-480PG01	H11634	17
Line Post - Porcelain	LP-R7EH150-530PG01	H11652	17
Line Post - Porcelain	LP-R12EH150-460PG03	H11389 (5158AX)	17
Line Post - Porcelain	LP-R11ET150-610PG	H11173	17
Line Post - Porcelain	LP-R11EH150-634PG	H11174	17
Line Post - Porcelain	LP-R11ET200-610PG	H11368	17
Line Post - Porcelain	LP-R12.5ET200-920PG	H11461	17
Line Post - Porcelain	LP-R11EC200-825PG	H11472	17
Line Post - Porcelain	LP-R11EH200-825PG	H11529	17
Line Post - Porcelain	LP-R11ET250-1300PG	H11654	17
Line Post - Porcelain	LP-R12.5EH250-1295PG02	H11669	17
Line Post - Porcelain	LP-R11EH350-1300PG	H11619	17

Insulators

Quick Reference Guide

Catalogue Section	Catalogue Reference	Old Catalogue/Drawing Number	Page No
Line Post - Porcelain	LP-R12.5ET350-1510PG	H11647	17
Line Post - Porcelain	LP-R12.5EH350-1830PG04	5409AX	17
Line Post - Porcelain	LP-R12.5ET350-1920PG	H11167 (5350AX)	17
Line Post - Porcelain	LP-R12.5EC350-1920PG	H11170	17
Line Post - Porcelain	LP-R12.5EH350-1920PG	H11171	17
Line Post - Porcelain	LP-R12.5EH350-1920PG02	H11251	17
Line Post - Composite	LP-R12.5ET200-1074CER	RLP-43R-FG-M24NPG-M	18
Line Post - Composite	LP-R12.5EC244-1074CER	RLP-43R-VG-M24NPG-M-OS	18
Line Post - Composite	LP-R12.5EH244-1074CER	RLP-43R-HG-M24NPG-M-OS	18
Line Post - Composite	LP-R11EH370-1958CSG02	NPKG30XH016S0-120	18
Line Post - Composite	LP-R9EH430-2354CSG03	NPKN30XH019S0-120	18
Line Post - Composite	LP-R6EH640-3700CSG05	NBKG30XH030E0-108	18
Line Post - Composite	LP-R7EH650-3476CSG03	NPKN30XH030S0-120	18
Line Post - Composite	LP-R7EH650-3700CSG02	NPKG30XH030S0-120	18
Line Post - Composite	LP-R6ED655-3472CSG02	NPSN30XH030	18
Line Post - Hybrid	LP-R12.5ET125-540PSR	5472AX	19
Line Post - Hybrid	LP-R12.5ET145-646PSR	5468AX	19
String - Discs	DI-U70C292-PG	D70C	24
String - Discs	DI-U70C292-PGH	D70CH	24
String - Discs	DI-U70BL295-PBW	D70S	24
String - Discs	DI-U70BL320-GVZW	D70SGZ	24
String - Discs	DI-U70C320-GV	D70CG	24
String - Discs	DI-U70C320-GVZ	D70CGZ	24
String - Discs	DI-U70BL400-GVZR	U70ASZ	24
String - Discs	DI-U80BL320-GVW	B8/146	24
String - Discs	DI-U80BL320-GVZW	B8/146DC	24
String - Discs	DI-U80BL390-GVZW	B8P-A/146DC	24
String - Discs	DI-U100BL390-GVZR	F9P/146DC	24
String - Discs	DI-U120BL292-PGW	2151AX	24
String - Discs	DI-U120BL320-GVZR	F12.02/146DC	24
String - Discs	DI-U125BS320-GVZW	B13/146DC	24
String - Discs	DI-U160BS305-PGW	D160S(2219AX)	24
String - Discs	DI-U160BS445-GVZW	B160/146DC	24
String - Discs	DI-U190B550-GVZW	B190P/170	24
String - HV Composite	LR-CS70CT340-1822CSG	NCT70XM021	27
String - HV Composite	LR-CS120EY360-1800CSG	NEY120XM021S0-000	27
String - HV Composite	LR-CS160EE360-1800CSG	NEE160XM021S0-000	27
String - HV Composite	LR-CS120YB390-1935CSG	FYB120XM023S0-000	27
String - HV Composite	LR-CS70SB390-1937CSG	FSB70XM023S0R0	27
String - HV Composite	LR-CS70SB425-2118CSG	FSB70XM025S0-000	27
String - HV Composite	LR-CS70SB430-1960CSG	FSB70XM021R3S	27
String - HV Composite	LR-CS70SB485-2446CSG	FSB70XM029S0R0	27
String - HV Composite	LR-CS160SB685-3641CSG	FSB160XM043S0-000	27

Insulators

Quick Reference Guide

Catalogue Section	Catalogue Reference	Old Catalogue/Drawing Number	Page No
String - HV Composite	LR-CS70SB690-3629CSG	FSB70XM043S0-000	27
String - HV Composite	LR-CS120EY690-3641CSG	NEY120XM043S0-000	27
String - HV Composite	LR-CS120YE690-3641CSG	NYE120XM043S0-000	27
String - HV Composite	LR-CS160EB690-3641CSG	FEB160XM043S1-000	27
String - HV Composite	LR-CS120SB690-3735CSG	FSB120XM043S0R0	27
String - HV Composite	LR-CS160SB750-3982CSG	FSB160XM047S0-000	27
String - HV Composite	LR-CS70SB750-3988CSG	FSB70XM047S0-000	27
String - HV Composite	LR-CS160SB1075-5829CSG	FSB160XM069S1-000	27
String - HV Composite	LR-CS160SB1310-7187CSG	FSB160XM085S2R0	27
Pin Insulators	PI-SLP/11/180-PG	P11	34

TE Connectivity (NYSE: TEL) is a \$14 billion global technology leader. Our connectivity and sensor solutions are essential in today's increasingly connected world. We collaborate with engineers to transform their concepts into creations - redefining what's possible using intelligent, efficient and high-performing TE products and solutions proven in harsh environments. Our 80,000 people, including 7,500 design engineers, partner with customers in over 150 countries across a wide range of industries. We believe EVERY CONNECTION COUNTS - te.com.

Markets

- Mining
- Nuclear
- Petrochemical
- Rail
- Windfarm
- Solar
- Hydroelectric

Applications

- Overhead Distribution
- Street Lighting
- Substations
- Transmission
- Underground Distribution

WHEREVER ELECTRICITY FLOWS, YOU'LL FIND TE ENERGY



te.com/energy

TE Customer Support Centres

NSW/QLD/NT/ACT: +61 (2) 9554 2695
VIC/TAS/SA: +61 (3) 9271 5243
WA: +61 (8) 9358 7806
New Zealand: +64 (9) 634 4580

te.com

TE Connectivity, TE Connectivity (logo) and Every Connection Counts are trademarks. All other logos, products and/or company names referred to herein might be trademarks of their respective owners.

The information given herein, including drawings, illustrations and schematics which are intended for illustration purposes only, is believed to be reliable. However, TE Connectivity makes no warranties as to its accuracy or completeness and disclaims any liability in connection with its use. TE Connectivity's obligations shall only be as set forth in TE Connectivity's Standard Terms and Conditions of Sale for this product and in no case will TE Connectivity be liable for any incidental, indirect or consequential damages arising out of the sale, resale, use or misuse of the product. Users of TE Connectivity products should make their own evaluation to determine the suitability of each such product for the specific application.

© 2015 TE Connectivity Ltd. family of companies All Rights Reserved.

EPP-1908-AU-5/15

INSULATORS

TE Connectivity Energy

Unit 2 3 Corella Close
Berkeley Vale NSW Australia
Tel +61 2 4389 6000
www.te.com
TE CONNECTIVITY AUSTRALIA PTY LTD