

**B-138 Series, Rated up to 60 Amps, 115/200 VAC, 400 Hz**

**Product Facts**

- TPST NO and TPDT NC
- Gasket sealed or Hermetically sealed
- 115/200 VAC, 400 Hz, 3 phase
- Auxiliary contacts available
- Meets the requirements of MIL-PRF-6106



**Performance Data**

**Electrical Characteristics**

- Contact Arrangement** — TPST NO and TPDT NC
- Rated Operating Voltage** — 115/200 VAC, 400 Hz, 3 phase
- Current, Resistive** — 60 Amps
- Current, Inductive** — 60 Amps
- Current, Motor** — 60 Amps
- Current, Rupture** — 600 Amps

**General Characteristics**

- Temperature Range** — -55°C to +71°C
- Operating Cycles (Life) at Rated Resistive Load, Min.** — 50,000 cycles
- Operating Cycles (Life) Mechanical, Min.** — 100,000 cycles
- Dielectric Strength** — All Circuits to Ground — 1,500 Vrms  
Circuit to Circuit — 1,500 Vrms  
Coil to Ground and Aux. Contacts — 1,000 Vrms
- Altitude Max.** — 50,000 ft.
- Weight, Nominal** — 1.50 to 2.0 lbs

**Coil Characteristics**

- Duty Cycle** — Continuous or continuous with suppression
- Operating Voltage, Nom.** — 28 Vdc
- Pickup Voltage, Max. @ 85°C** — 18 Vdc
- Dropout Voltage, Max.** — 1.5 to 7 Vdc
- Coil Current @ 29 Vdc Max. @ 25°C** — 0.5 Amps
- Inrush** — 5 Amps

**Coil Type**

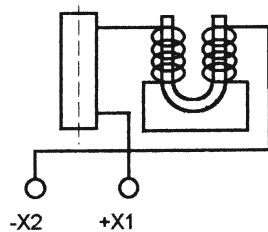

A — Continuous

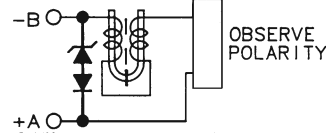

B — Continuous with Suppression

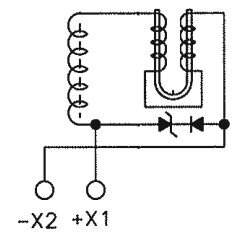

C — Continuous with Suppression

For factory-direct application assistance, phone 419-521-9500 or fax 419-526-2749.

**B-138 Series, Rated up to 60 Amps, 115/200 VAC, 400 Hz (Continued)**

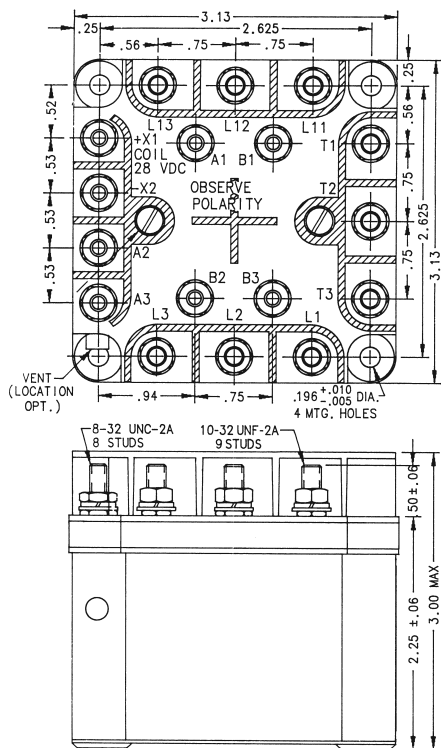

Mounting Style A

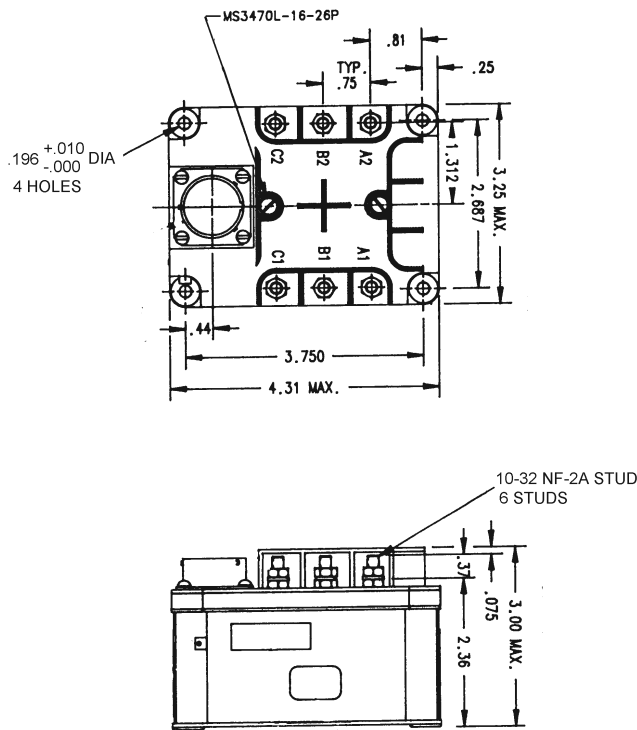

Mounting Style B

**Circuit Configurations** (Consult factory for other available circuit configurations)

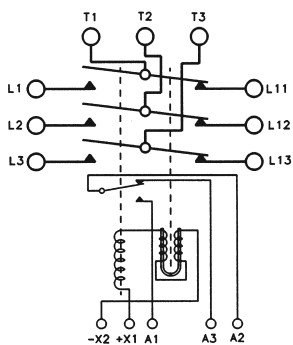

Circuit Configuration 1

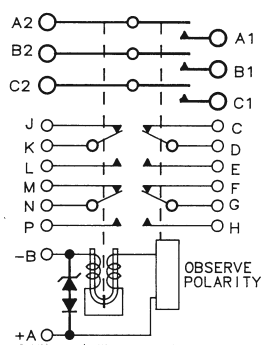

Circuit Configuration 2

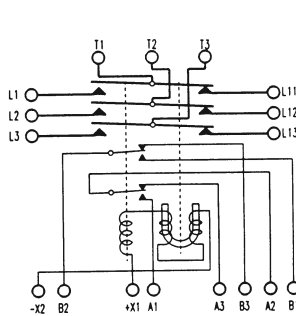

Circuit Configuration 3

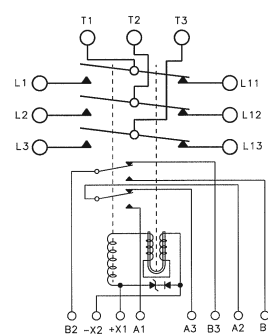

Circuit Configuration 4

HARTMAN Part Number	Construction Type	Mounting Style	Coil Type	Circuit Config.	TE Part Number
B-138S	Gasket/Vented	B	B	2	1616002-5
B-138XEH	Gasket/Vented	A	C	4	1616028-3
B-138BH	Gasket/Vented	A	A	1	1616028-1
B-138XAH	Gasket/Vented	A	A	3	1616028-2

For factory-direct application assistance, phone 419-521-9500 or fax 419-526-2749.