



Twin BNC Connectors

Product Facts

- Crimp connectors require only one-stroke crimping of both conductors, plus braid and cable support
- Lower installed cost with one-stroke crimp
- Reduced noise levels because of Tyco Electronics solderless crimping techniques
- Captive inner contact stability
- No danger of heat damage to coaxial cable
- Ease of inspection
- Listed under the Component Program of Underwriters Laboratories Inc., File No. E81956 
- PC Board soldered connectors are recognized under the Component Program of Underwriters Laboratories Inc., File No. E81956 
- Certified by Canadian Standards Association File No. LR 7189 

Packaging — All connectors are packaged individually unless otherwise noted.

The Twin BNC Connector is a quick connect/disconnect, weatherproof connector designed in accordance with MIL-C-39012 to meet the stringent requirements of MIL-STD-1553 Multiplex Data Bus.

These twin coaxial cable connectors are a unique development by Tyco Electronics which has resulted in the production of high level RF components. Termination of these connectors to twin conductor cable is made with Tyco Electronics exclusive one crimp method which simultaneously terminates inner conductors, outer braid and cable support with one stroke of the matching Tyco Electronics tool.

These rugged connectors accommodate today's most commonly used twin conductor cable sizes.

Materials

Brass — QQ-B-626
Beryllium Copper — QQ-C-530
PTFE — MIL-P-19468
Polypropylene — General purpose
Copper, Annealed — QQ-C-576
Phosphor Bronze — QQ-B-750
Silicone Rubber — ZZ-R-765

Plating

Silver — QQ-S-365
Nickel — QQ-N-290
Tin — ASTM-B-545



Electrical Characteristics

Nominal Impedance — Non-constant
Working Voltage — 500 volts rms sea level
Insulation Resistance — 5000 megohms min.
Dielectric Withstanding Voltage — 1500 volts rms sea level

Mechanical Characteristics

Mating/Unmating — Bayonet lock-quick connect/ disconnect
Cable Attachment — Crimp type - Simultaneous center and braid
Coupling Nut Retention — 100 lbs. [444 N] min.
Cable Retention — 25 lbs. [111 N] min., RG 108A/U cable
Durability — 200 cycles per MIL-C-39012

Environmental Characteristics

Temperature Range — -55°C to +85°C
Vibration — MIL-STD-202, Method 204, Condition B
Shock — MIL-STD-202, Method 213, Condition I, 100 G's
Salt Spray — MIL-STD-202, Method 101, Condition B
Temperature Cycling — MIL-STD-202, Method 102, Condition C

Twin BNC Connectors (Continued)

Plugs

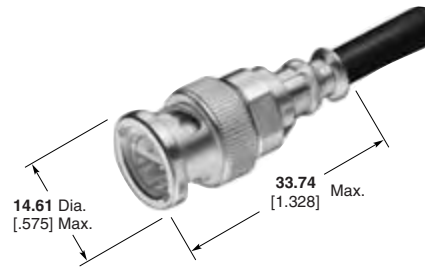

RG/U Cable	Center Contact Plating	Body Plating	Dielectric	Integral Die Hand Tool	Part No.
108, 108A	Silver	Silver	PTFE	69667	5332225
BELDEN 9272, 89272	Silver	Nickel	Polypropylene	69667	5332225-5
TROMPETER TWC-124-2	Silver	Silver	PTFE	69667	5332225-3
ROLM 49D2401 RAYCHEM 7824D013	Silver	Nickel	Polypropylene	69667	5332225-6

Bulkhead Jack

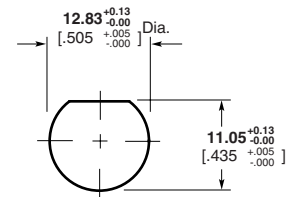
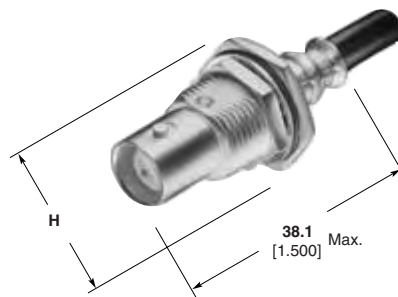

Maximum Panel Thickness 3.18 [.125]

Recommended Panel Cutout

H = 17.45 [.687] Max. across flats, 20.32 [.800] Max. across points

RG/U Cable	Center Contact Plating	Body Plating	Dielectric	CERTI-CRIMP Hand Tool with Integral Die	Integral Die Hand Tool	Die Insert for Tools: Hand Tool-69710-1, 626 Pneu. Head 318161-1	Part No.
108, 108A BELDEN 9272, 89272	Silver	Silver	PTFE	—	69667	69708	5332342

BELDEN is a trademark of Belden Wire and Cable Company.

ROLM is a trademark of the Rolm Corp.

TROMPETER is a trademark of Trompeter Electronics, Inc.

Note: Part Numbers are RoHS compliant except: ♦ Indicates non-RoHS compliant.

Twin BNC Connectors (Continued)

**Right-Angle
PC Board/
Panel Mount Jacks**

Material

Body — VALOX, White
Center Contacts — Gold
Dielectric — Polymethylpentene

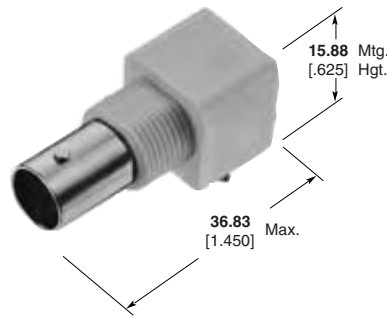

**With Mounting Posts
Part No. 5228686-1**

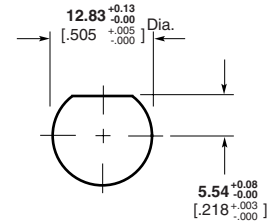

Maximum Panel Thickness 6.1 [0.240]

Recommended Panel Cutout

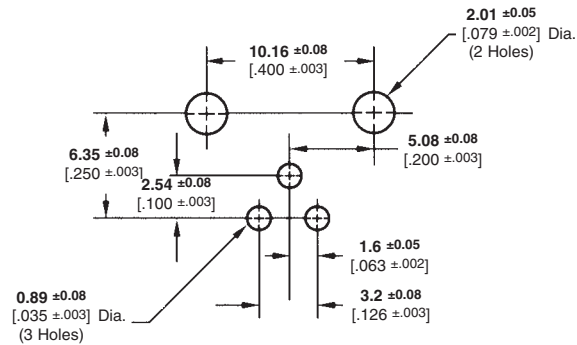

Recommended PC Board Layout

**Vertical
PC Board/
Panel Mount Jacks**

Material

Body — VALOX, White
Center Contacts — Gold
Dielectric — Polymethylpentene



**With Mounting Posts
Part No. 5221198-1**

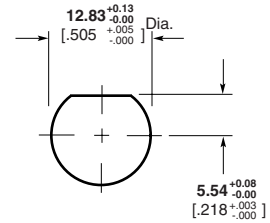

Maximum Panel Thickness 6.1 [0.240]

Recommended Panel Cutout

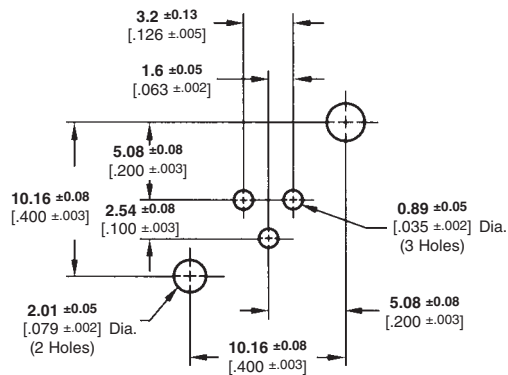

Recommended PC Board Layout

Lockwasher and Jam Nut



**Part No.
1-329632-2**



**Part No.
1-329631-2**

VALOX is a trademark of General Electric Company.

Note: Part Numbers are RoHS compliant except: ♦ Indicates non-RoHS compliant.

Twin BNC Connectors (Continued)

**Vertical
PC Board Mount
Jack**

Plating

Body — Nickel

Center Contacts — Gold

Dielectric — Polymethylpentene

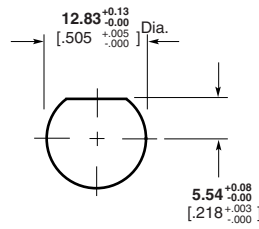

Part No. 5415832-1
Recommended Panel Cutout

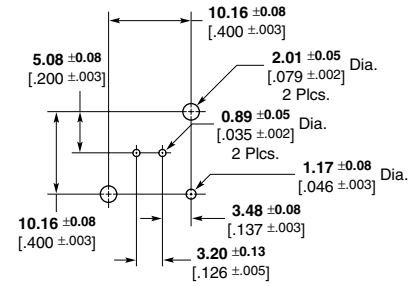

PCB Configuration

**Bulkhead Jack
Adapter**

Plating

Body — Silver

Center Contacts — Silver

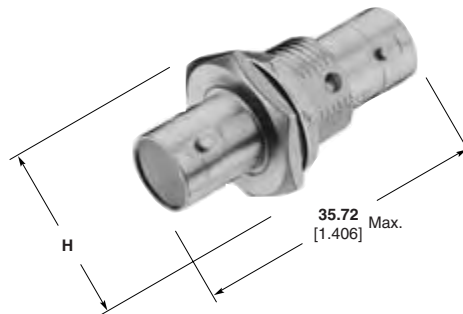

H = 17.45 [.687] Max. across flats, 20.32 [.800] Max. across points

Part No. 5332215

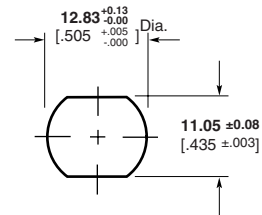

Maximum Panel Thickness 3.18 [.125]

Recommended Panel Cutout

Note: Part Numbers are RoHS compliant except: ♦ Indicates non-RoHS compliant.