



L000340-01

Ultra-Flexible Tri-Band Vehicle Whip Antenna VHF, UHF, 700/800/900 MHz

The L000340-01 tri-band vehicle whip antenna has been designed as an addition or replacement for existing vehicle whip antennas which accept an M6 x 0.75mm stud.

This antenna operates over VHF, UHF and 700/800/900 MHz bands with impressive gain and consistent radiation patterns across all frequencies.

FEATURES AND BENEFITS

- Tri-band coverage from a single antenna
- M6 x 0.75 stud compatible with the TE Connectivity FP20 auto and other popular vehicular antenna bases
- Rigorously tested for humidity, shock, vibration, impact, bend, pull and more
- Increased flexibility compared to competing products

APPLICATIONS

- Public Safety
- Emergency Services
- First Responders
- Freight
- Transportation

ELECTRICAL SPECIFICATION

Operating Frequency (MHz)	150-160	160-175	450-485	485-512	735-806	806-870	870-960
VSWR - Typ.	<1.5:1	<1.8:1	<1.5:1	<1.8:1	<1.5:1	<1.5:1	<2.2:1
Peak Gain - Max (dBi)	0.52	0.7	3.80	2.94	3.40	3.40	2.26
Input Max Power (W)	60	60	45	45	35	35	35
Polarization	Linear, Vertical						
Azimuth Beamwidth	360 °, Omnidirectional						
Nominal Impedance (Ohms)	50						

MECHANICAL SPECIFICATION

Dimensions - height x circumference at base - mm (in.)	416 x 14.5Ø (16.38 x 0.57Ø)
Weight - g (oz.)	38 (1.34)
Connector	M6 x 0.75mm Stud

ENVIRONMENTAL SPECIFICATION

Operating Temperature - °C (°F)	-30 to +85°C (-22 to +185°F)
Storage Temperature - °C (°F)	-40 to +85°C (-40 to +185°F)
Temperature Cycling	IEC 68-2-14; -40°C to +85°C (Storage)
Ingress Protection (IP Rating)	IP67
Wind Survival (Operational) - MPH	136
Humidity	MIL-STD-810G, 507.5, Procedure II, Aggravated Humidity
Thermal Shock	IEC 68-2-14; -25°C to +70°C
Corrosive Atmosphere (Salt Fog/Mist)	MIL-STD-810G, Method 509.5
Vibration	MIL-STD-810G, Method 514.6, Category 4, Highway Truck Vibration
Mechanical Shock	IEC 60068-2-27, Secured Cross Country Vehicles
Impact Test	Fix antenna and strike 3/4 of a distance from the base of the antenna. 1500 strikes, 1 strike per second
Pull Test	20 pound pull on antenna for a duration of 30 seconds
Bend Test	1095 rotary cycles with the antenna bent at a 90° angle
Torque Test	15 lb-in Torque
Material Substance Compliance	RoHS Compliant

MECHANICAL DRAWINGS

Antenna

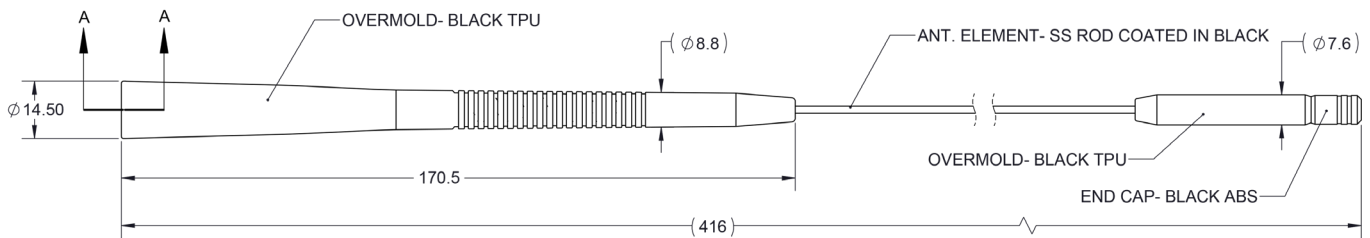

M6 Stud Connector

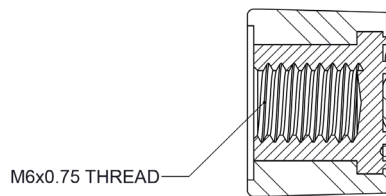

SECTION A-A
SCALE 3:1

VSWR

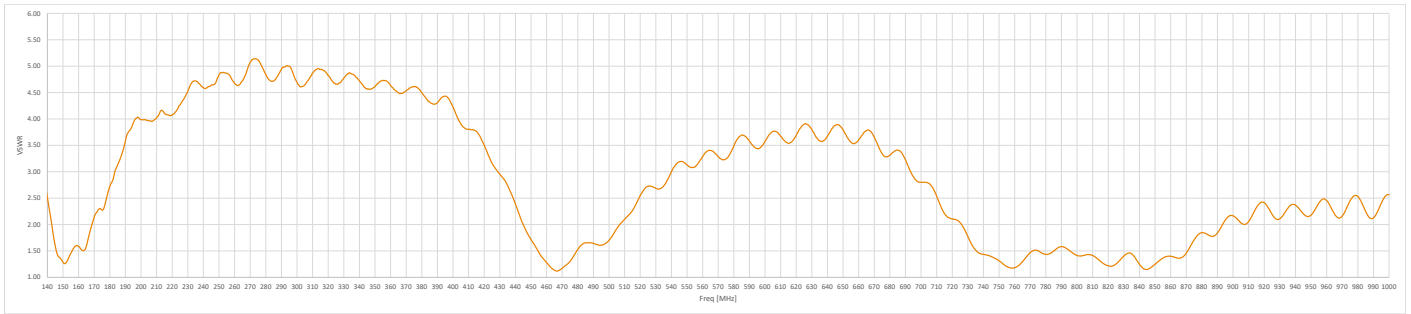

VSWR AT KEY FREQUENCY BANDS

150-175 MHz

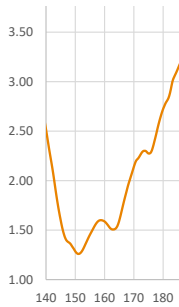

450-485 MHz

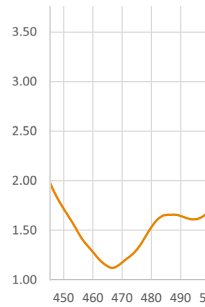

485-512 MHz

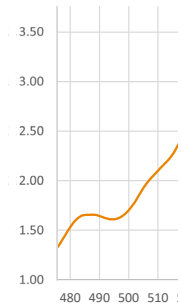

735-806 MHz

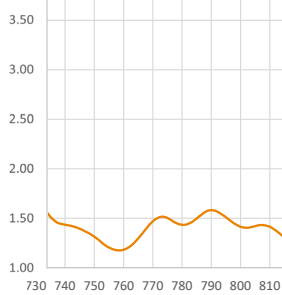

806-870 MHz

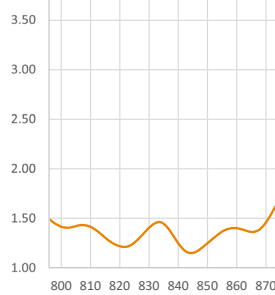

870-960 MHz

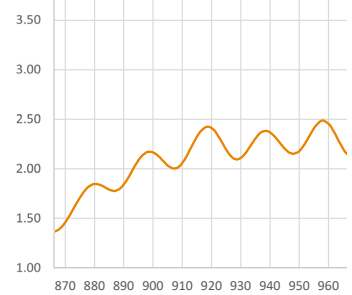

RADIATION PATTERNS



VHF RADIATION PATTERNS

Radiation Pattern at 150-160 MHz

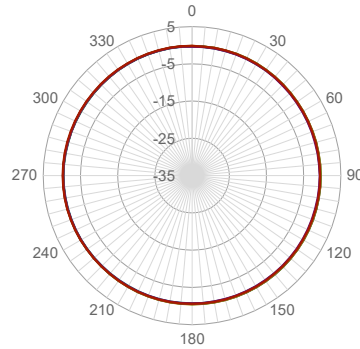

UHF RADIATION PATTERNS

Radiation Pattern at 450 MHz

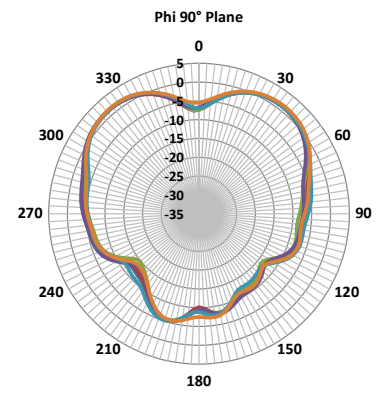
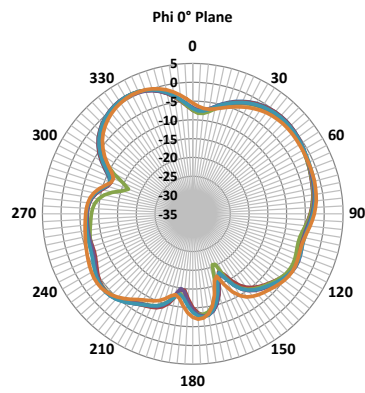
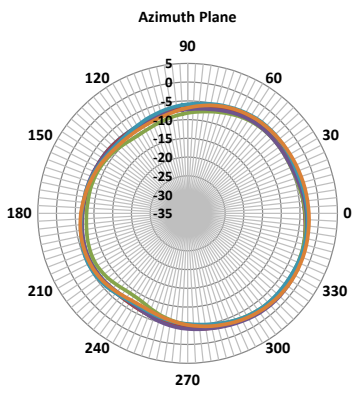

Radiation Pattern at 460 MHz

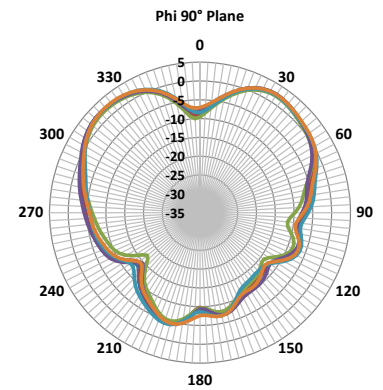
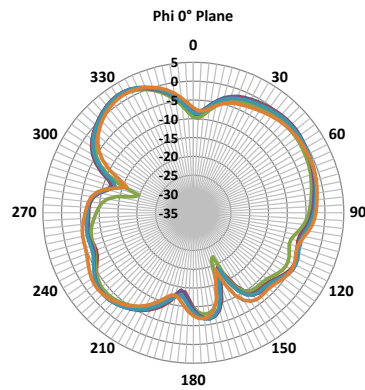
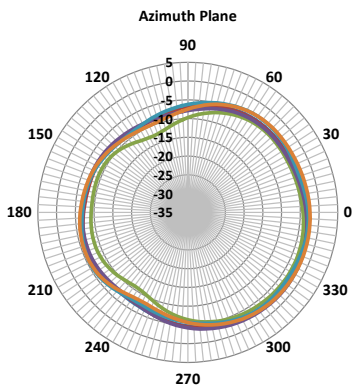

UHF RADIATION PATTERNS

Radiation Pattern at 470 MHz

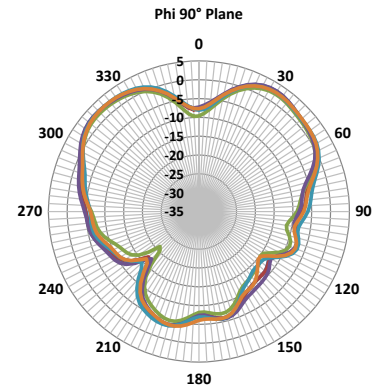
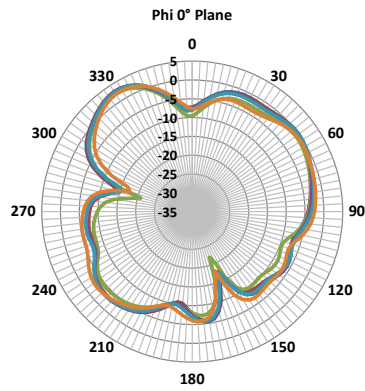
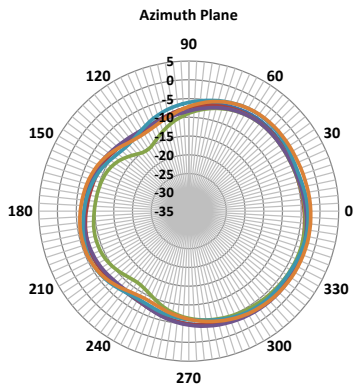

Radiation Pattern at 480 MHz

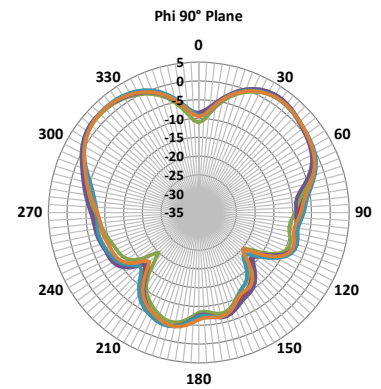
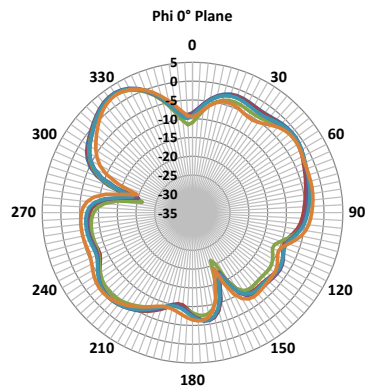
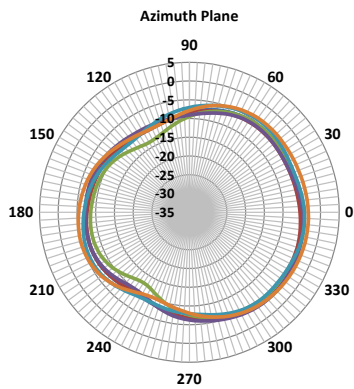

Radiation Pattern at 490 MHz

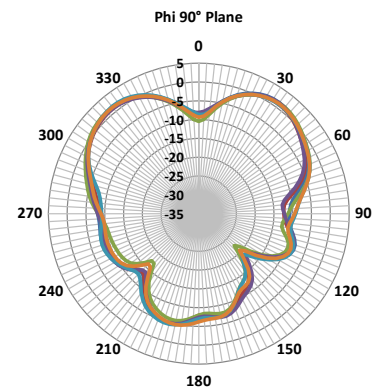
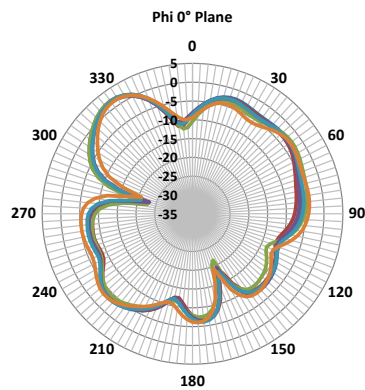
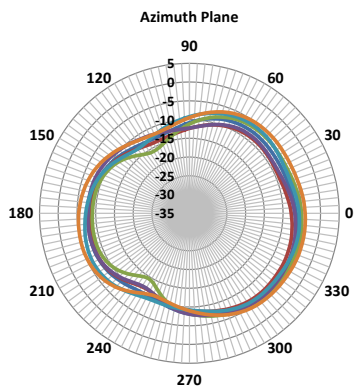

UHF RADIATION PATTERNS

Radiation Pattern at 500 MHz

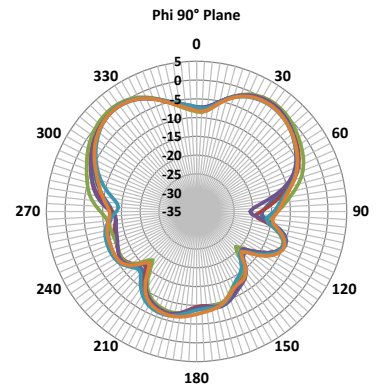
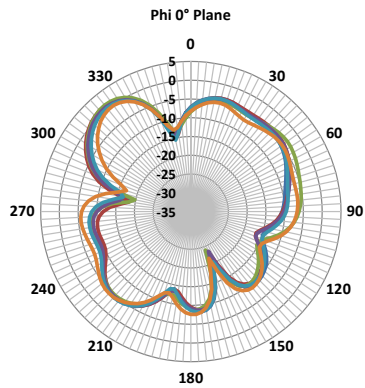
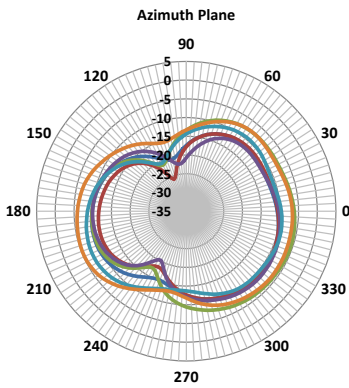

Radiation Pattern at 510 MHz

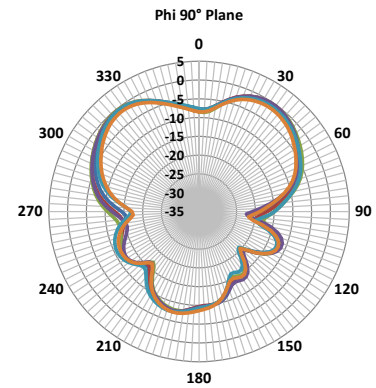
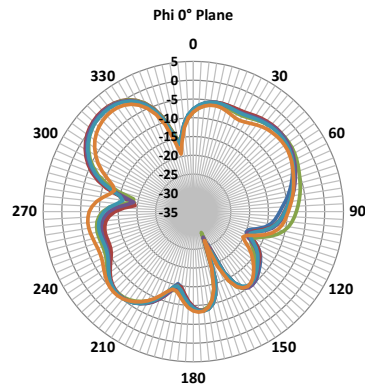
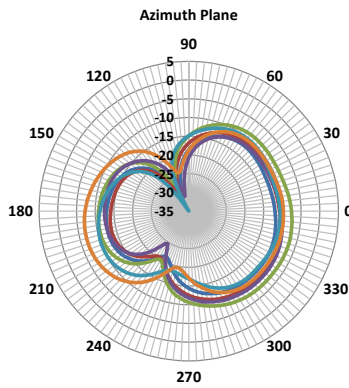

Radiation Pattern at 515 MHz

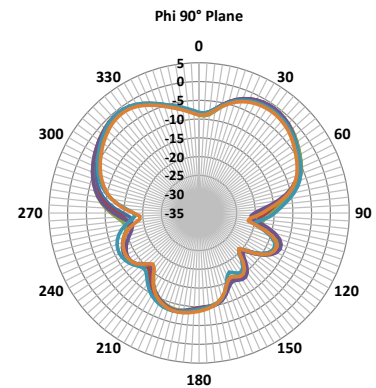
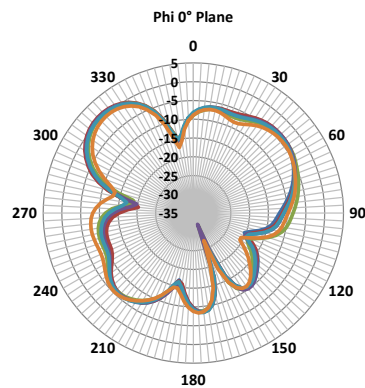
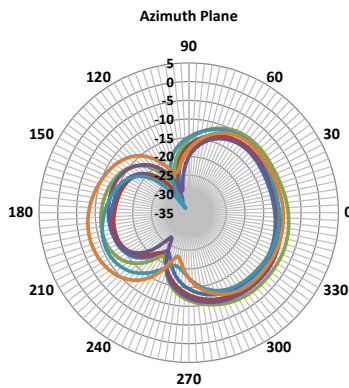

700/800 MHz RADIATION PATTERNS

Radiation Pattern at 745 MHz

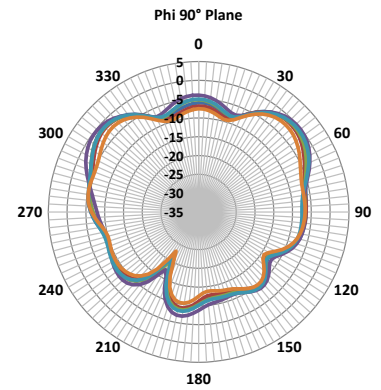
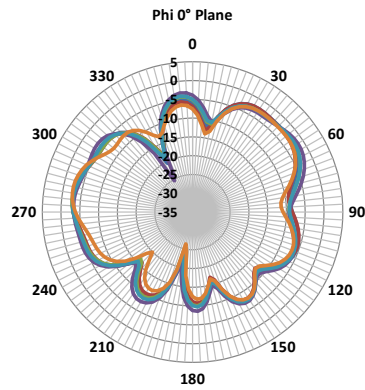
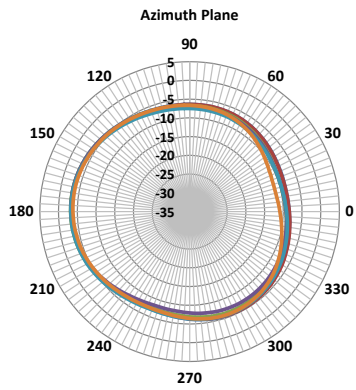

Radiation Pattern at 770 MHz

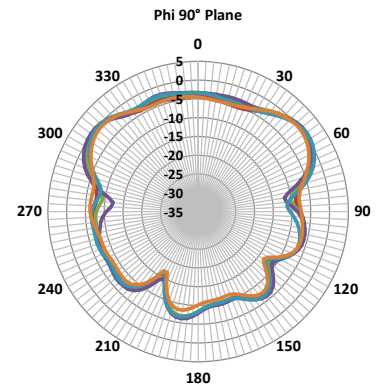
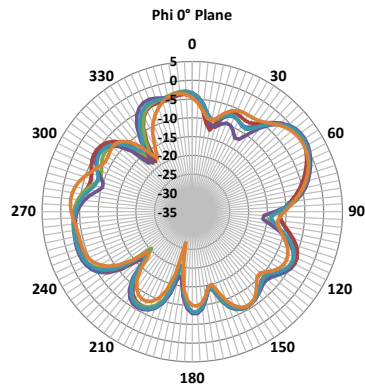
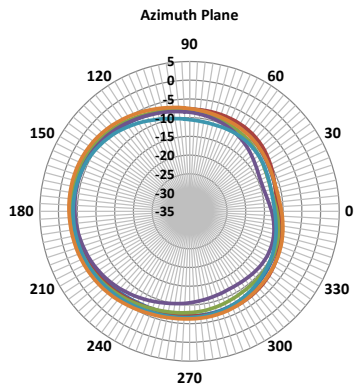

Radiation Pattern at 790 MHz

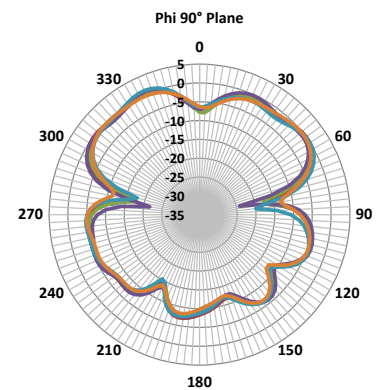
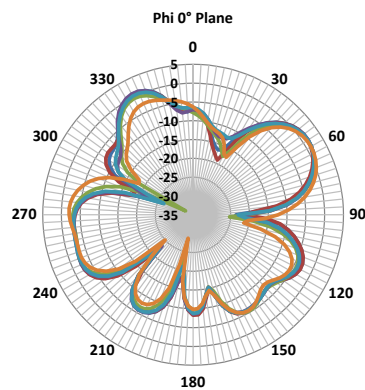
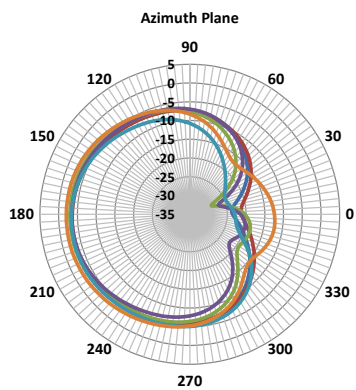

7/800 MHZ RADIATION PATTERNS

Radiation Pattern at 810 MHz

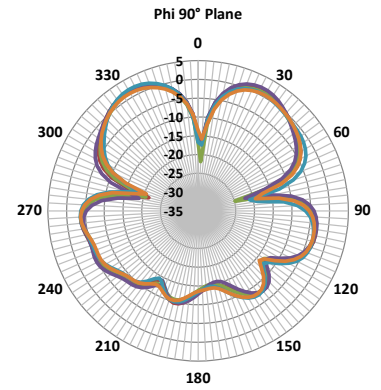
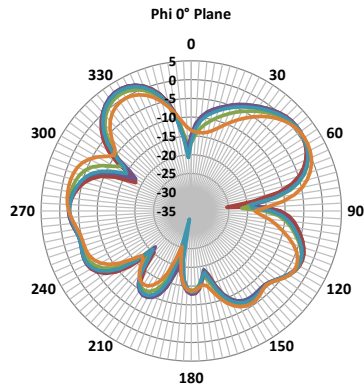
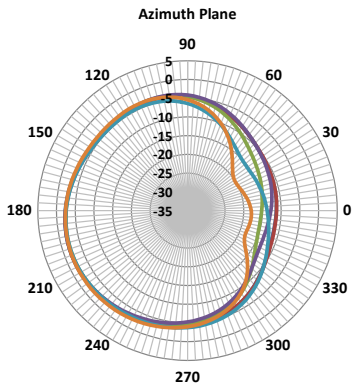

Radiation Pattern at 830 MHz

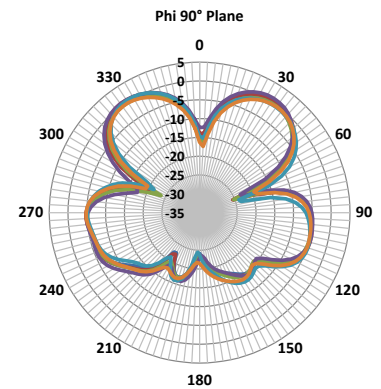
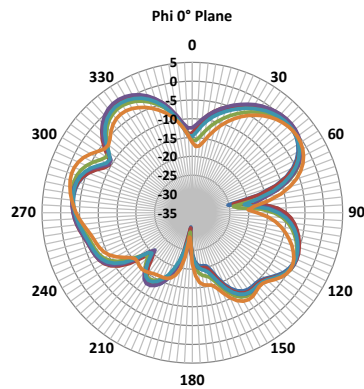
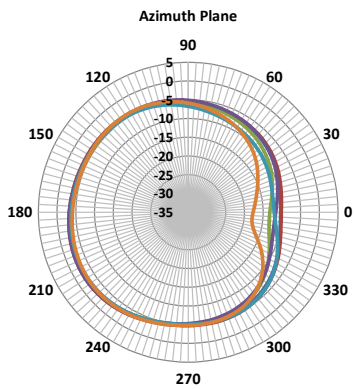

Radiation Pattern at 850 MHz

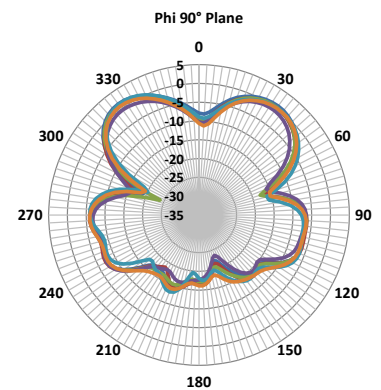
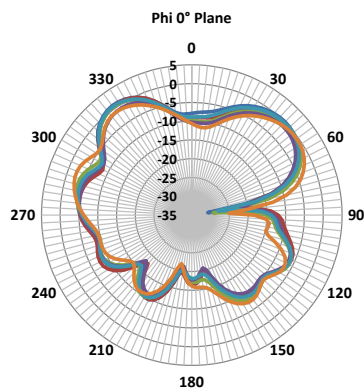
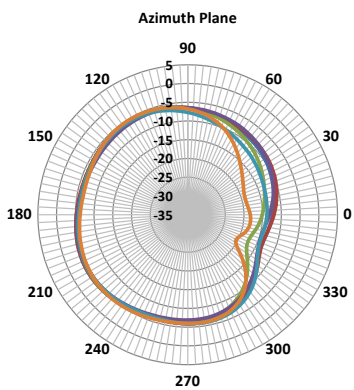

7/800 MHZ RADIATION PATTERNS

Radiation Pattern at 860 MHz

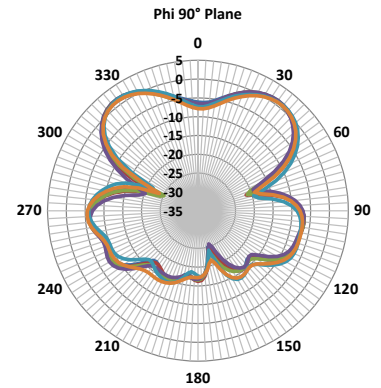
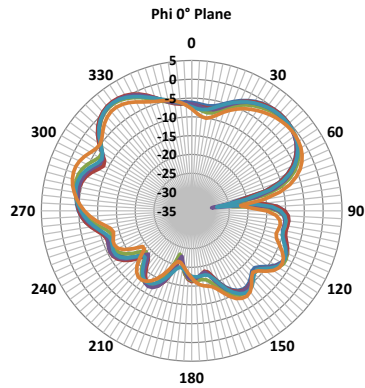
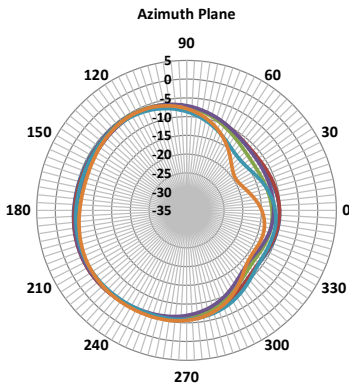

Radiation Pattern at 870 MHz

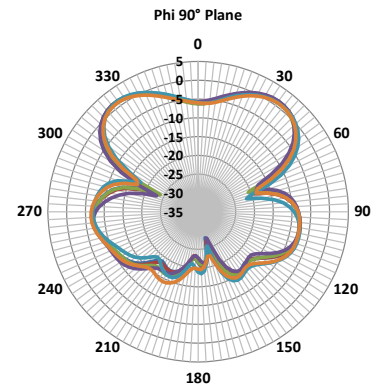
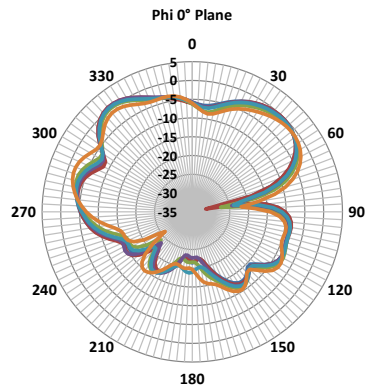
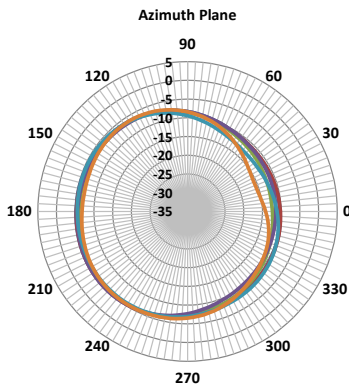

Radiation Pattern at 880 MHz

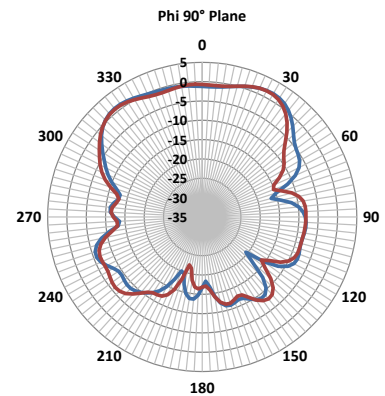
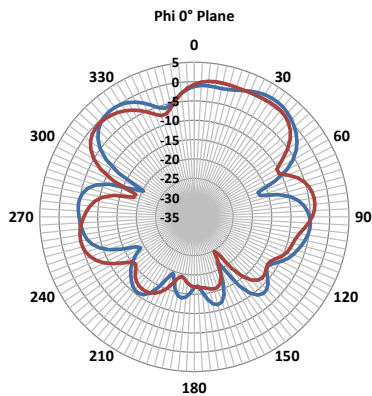
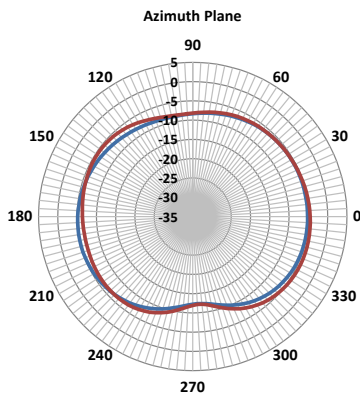

880-960 MHz RADIATION PATTERNS

Radiation Pattern at 896 MHz

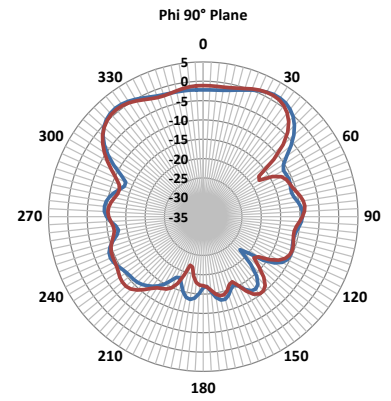
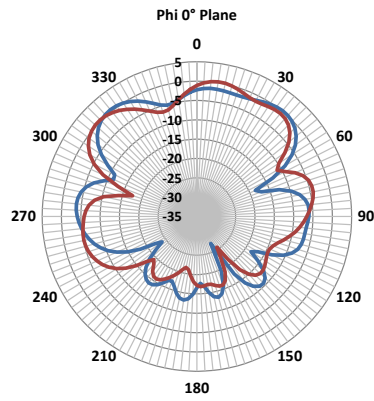
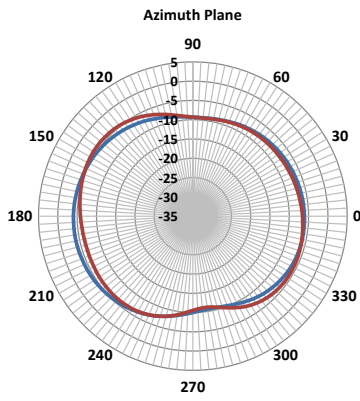

Radiation Pattern at 902 MHz

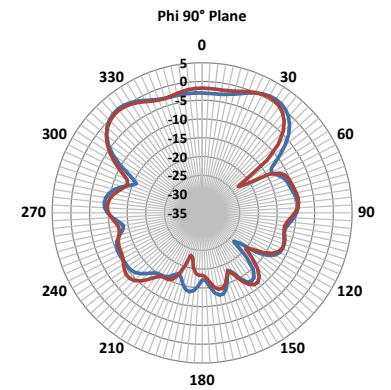
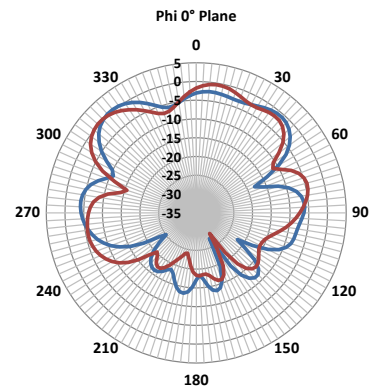
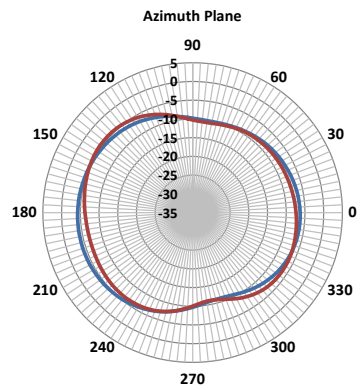

Radiation Pattern at 915 MHz

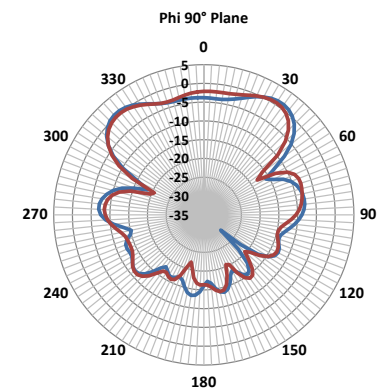
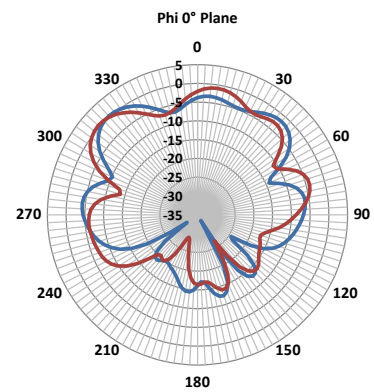
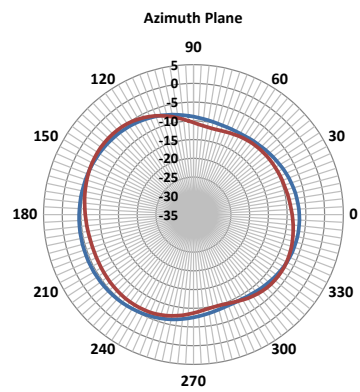

880-960 MHZ RADIATION PATTERNS

Radiation Pattern at 935 MHz

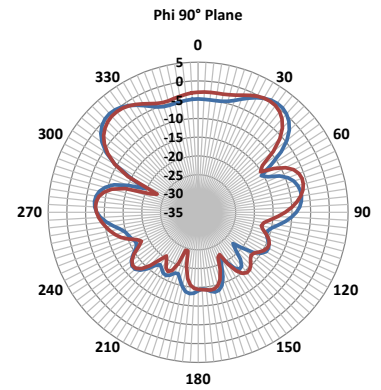
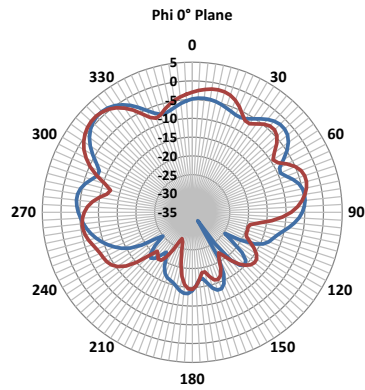
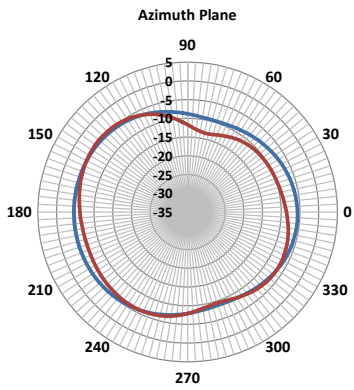

Radiation Pattern at 960 MHz

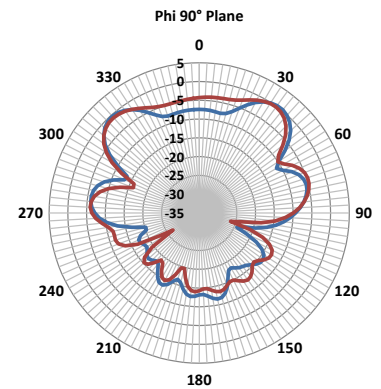
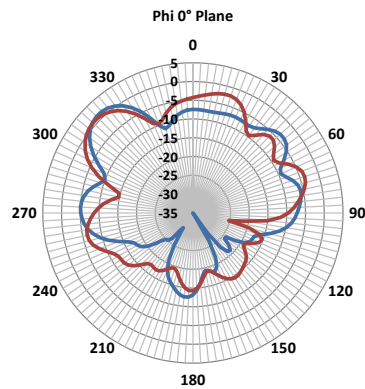
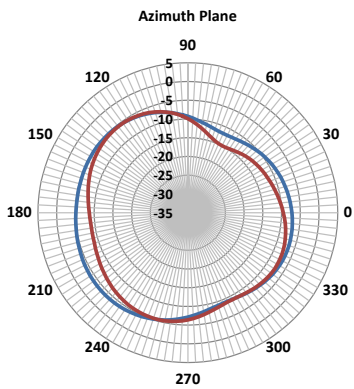

PACKING INFORMATION

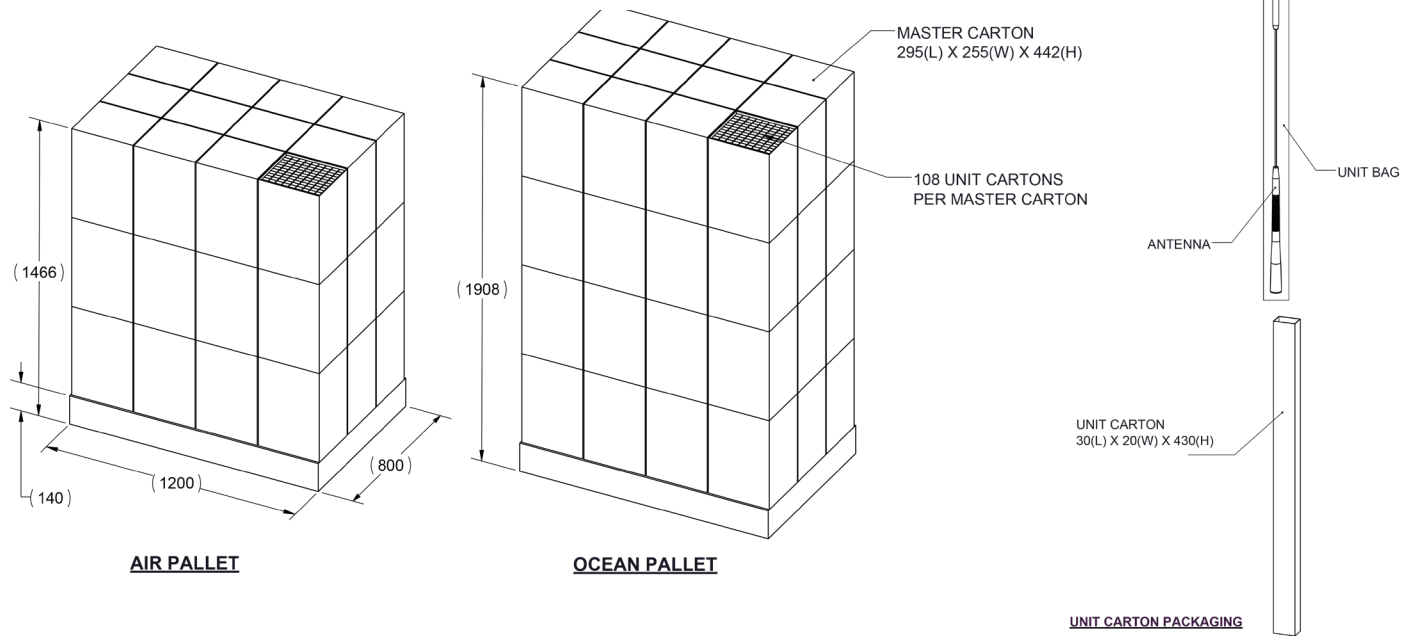

PACKAGED DIMENSIONS	UNIT CARTON	MASTER CARTON	AIR PALLET	OCEAN PALLET
Number of Antennas	1	108	3888	5184
Height mm(in)	430 (16.93)	442 (17.40)	1466 (57.71)	1908 (75.12)
Length mm(in)	30 (1.18)	295 (11.61)	1200 (47.24)	1200 (47.24)
Width mm(in)	20 (0.79)	255 (10.04)	800 (31.50)	800 (31.50)
Est. Shipping Weight kg (lbs)	0.06 (0.13)	6.8 (14.50)	275 (606.27)	356 (784.85)

TE TECHNICAL SUPPORT CENTER

- USA: +1 (800) 522-6752
- Canada: +1 (905) 475-6222
- Mexico: +52 (0) 55-1106-0800
- Latin/S. America: +54 (0) 11-4733-2200
- Germany: +49 (0) 6251-133-1999
- UK: +44 (0) 800-267666
- France: +33 (0) 1-3420-8686
- Netherlands: +31 (0) 73-6246-999
- China: +86 (0) 400-820-6015

te.com

TE, and TE connectivity (logo) are trademarks owned or licensed by the TE Connectivity Ltd. family of companies. All other logos, products and/or company names referred to herein might be trademarks of their respective owners.

The information given herein, including drawings, illustrations and schematics which are intended for illustration purposes only, is believed to be reliable. However, TE Connectivity makes no warranties as to its accuracy or completeness and disclaims any liability in connection with its use. TE Connectivity's obligations shall only be as set forth in TE Connectivity's Standard Terms and Conditions of Sale for this product and in no case will TE Connectivity be liable for any incidental, indirect or consequential damages arising out of the sale, resale, use or misuse of the product. Users of TE Connectivity products should make their own evaluation to determine the suitability of each such product for the specific application.

TE Connectivity warrants to the original end user customer of its products that its products are free from defects in material and workmanship. Subject to conditions and limitations TE Connectivity will, at its option, either repair or replace any part of its products that prove defective because of improper workmanship or materials. This limited warranty is in force for the useful lifetime of the original end product into which the TE Connectivity product is installed. Useful lifetime of the original end product may vary but is not to exceed one (1) year from the original date of the end product purchase.

©2023 TE Connectivity. All Rights Reserved.

02/23 Original

