

**Procedure for Terminating SolderTacts Triaxial Contacts  
D-602-1116 and D-602-1117 to Triaxial Cables,  
Raychem Part Numbers 9530D5317 and 5022E5111**

## **1. Purpose and Scope**

This engineering standard contains termination procedures covering the termination of D-602-1116 and D-602-1117 SolderTacts contacts to two specific Raychem triaxial cables: P/N 9530D5317 and P/N 5022E5111.

## **2.0 References**

Raychem Specification Control Drawings:

D-602-1116: Triaxial Connector, Plug, MIL-C-38999, Size 8

D-602-1117: Triaxial Connector, Socket, MIL-C-38999, Size 8

D-602-0152: Shielded Contact, Pin, Coaxial Cable

D-602-0153: Shield Contact, Socket, Coaxial Cable

## **3.0 Application Equipment and Tools**

1. CV-5300 Mini-Gun hot air heating tool with MG-1 reflector
2. AD-1319 contact holding fixture with AT-1319-14 cable clamp and AT-1319-22 contact adapter.
3. AD-1447 contact removal tool.
4. Shear type wire cutter: Miller Model 101-S or equivalent.
5. Sn63 solder per QQ-S-571
6. RMA flux: Alpha #611 or equivalent.
7. Solder pot
8. Hand tools: die-blade wire stripper, tweezers, diagonal cutter, etc.

## 4.0 Procedures

### 4.1 Cable Preparation

#### 4.1.1 Stripping Procedure for No. 9530D5317 Cable

Tolerances on stripping dimensions are  $\pm 0.015$  inch unless otherwise specified.

1. Strip the outer jacket 0.475 inch.

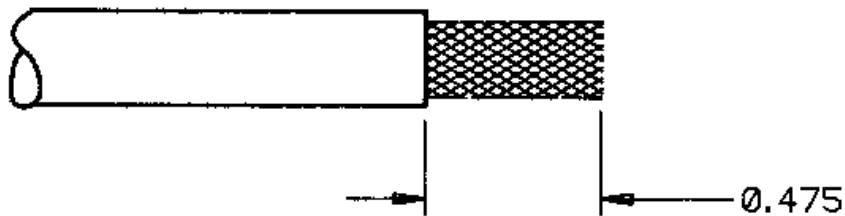

2. Trim the exposed braid back to the outer jacket.



3. Strip the outer jacket an additional 0.150 inch.

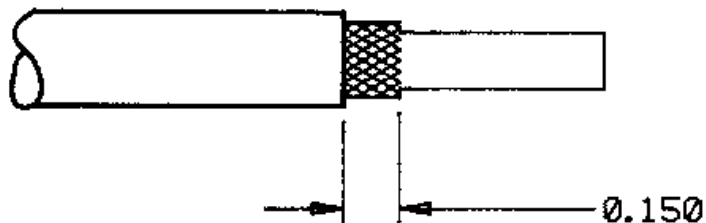

4. Comb out the exposed braid and fold it back over the outer jacket.



5. Trim the folded braid to 0.150 inch length.

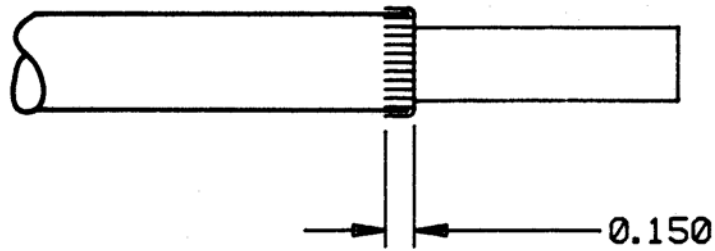

6. Strip the inner jacket 0.350 inch.

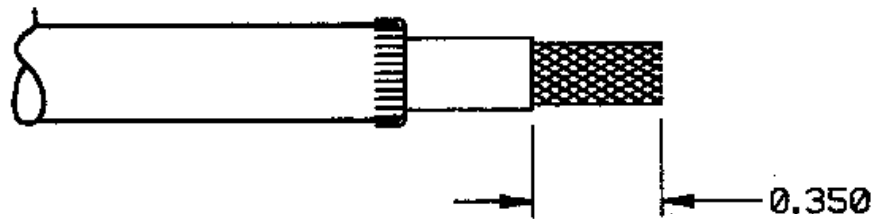

7. Trim the inner braid back to the inner jacket.



8. Strip the inner jacket an additional 0.175 inch.

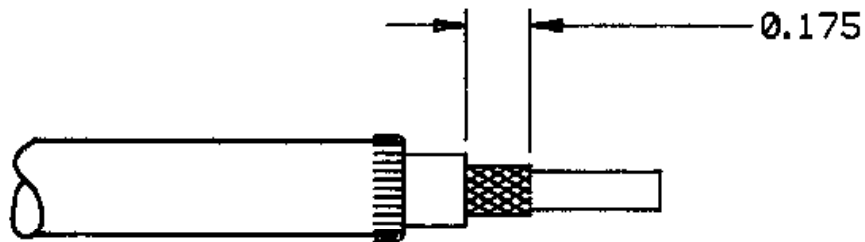

9. Strip the center conductor insulation 0.30 inch.

10. Pretrim the center conductor for a length of 0.25 inch.

- \* Flux the center conductor with type RMA flux (Alpha #611 or equivalent).
- \* Dip center conductor in molten Sn63 solder at  $500 \pm 20^{\circ}\text{F}$ .

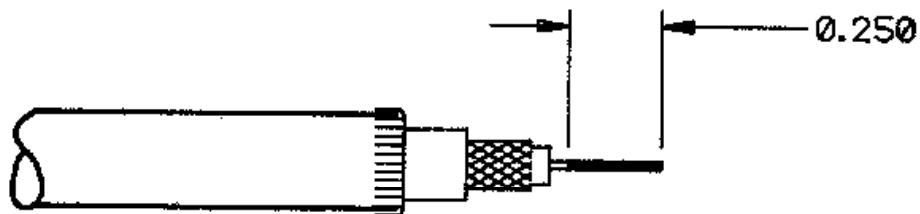

11. Fold the center conductor to a length of 0.175 inch.

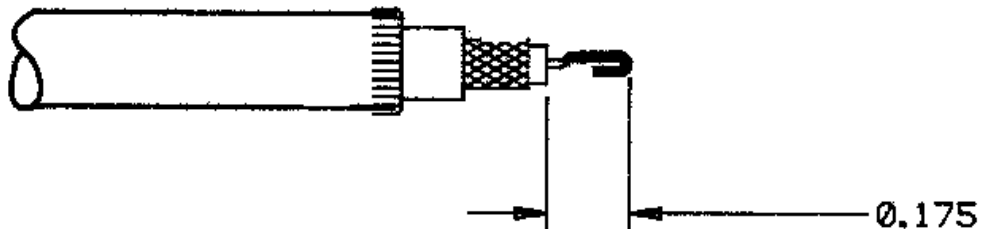

#### 4.1.1 Stripping Procedure for No. 5022E5111 Cable

Tolerances on stripping dimensions are  $\pm 0.015$  inch unless otherwise specified.

1. Strip the outer jacket 0.35 inch.

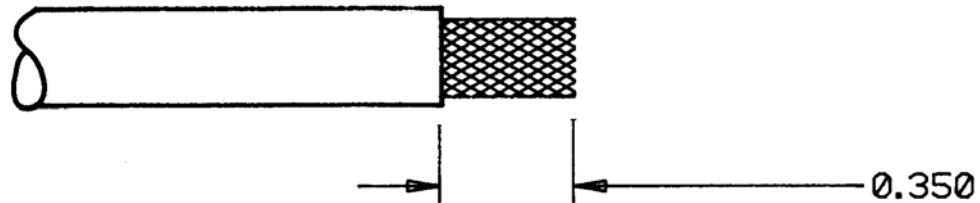

2. Trim the exposed braid back to the outer jacket.



3. Strip the outer jacket an additional 0.150 inch.

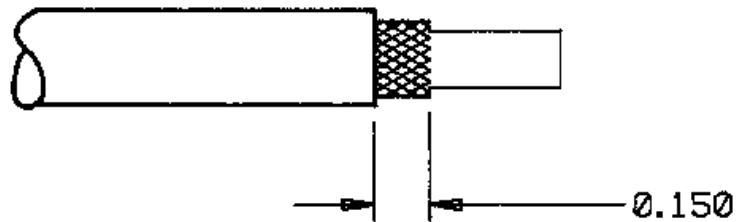

4. Comb out the exposed braid and fold it back over the outer jacket.



5. Trim the folded braid to 0.150 inch length.

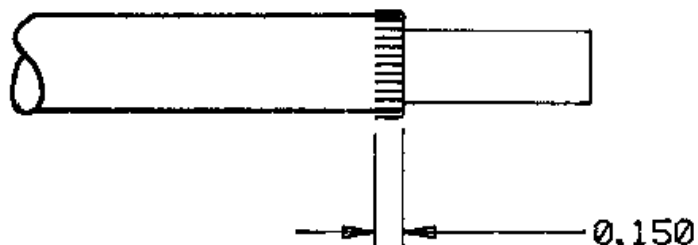

6. Strip the inner jacket 0.225 inch.

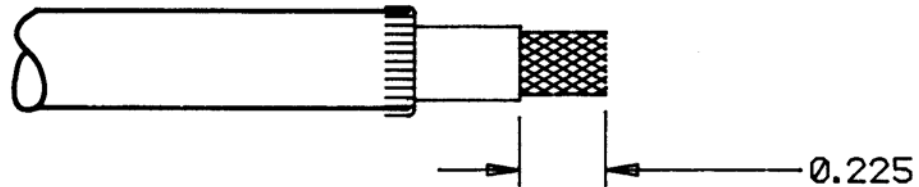

7. Trim the inner braid back to the inner jacket.

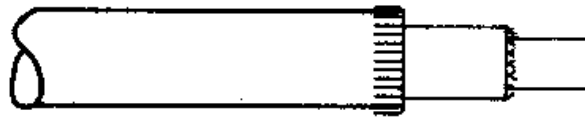

8. Strip the inner jacket an additional 0.125 inch.

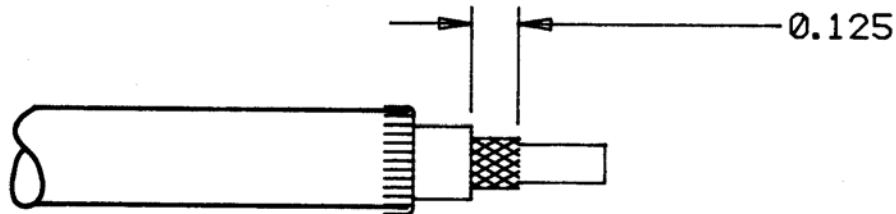

9. Strip the center conductor insulation 0.175 inch.

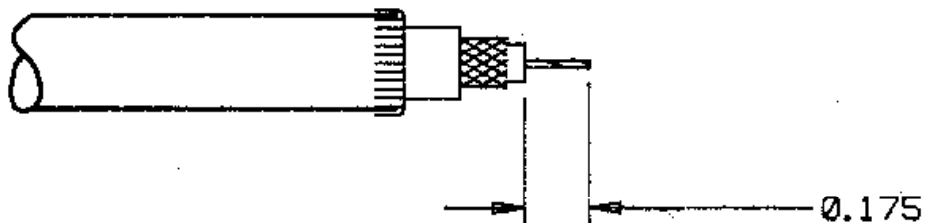

10. Pre-tin the center conductor for a length of 0.25 inch.

\* Flux the center conductor with type RMA flux (Alpha #611 or equivalent).

\* Dip center conductor in molten Sn63 solder at  $500 \pm 20^\circ\text{F}$ .

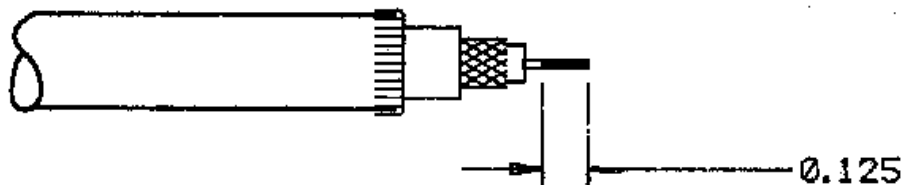

#### 4.2 Assembly and Heating Procedure

1. Make sure that the inner braid is neatly trimmed and that there are no braid strands poking out.
2. Make sure that the outer braid is folded back and neatly trimmed, with no braid strands of excess length.
3. Carefully insert the prepared cable into the rear of the inner contact assembly (D-602-0152 or D-602-0153).
  - \* Rotate the contact slightly during cable insertion to prevent the braid from catching.
  - \* Insert the cable until the center conductor can be seen through one of the forward inspection windows, and the inner braid can be seen through the rear inspection windows.
  - \* The center conductor can be seen through only one of the two forward inspection windows, and must extend through the solder preform visible within the window; magnification may be required.
4. Insert the contact into the AT-1319-14 adapter of the AD-1319 fixture, and clamp the cable in line with the contact.
  - \* Insert D-602-0152 pin contacts into the "P" end of the adapter.
  - \* Insert D-602-0153 socket contacts into the "S" end of the adapter.

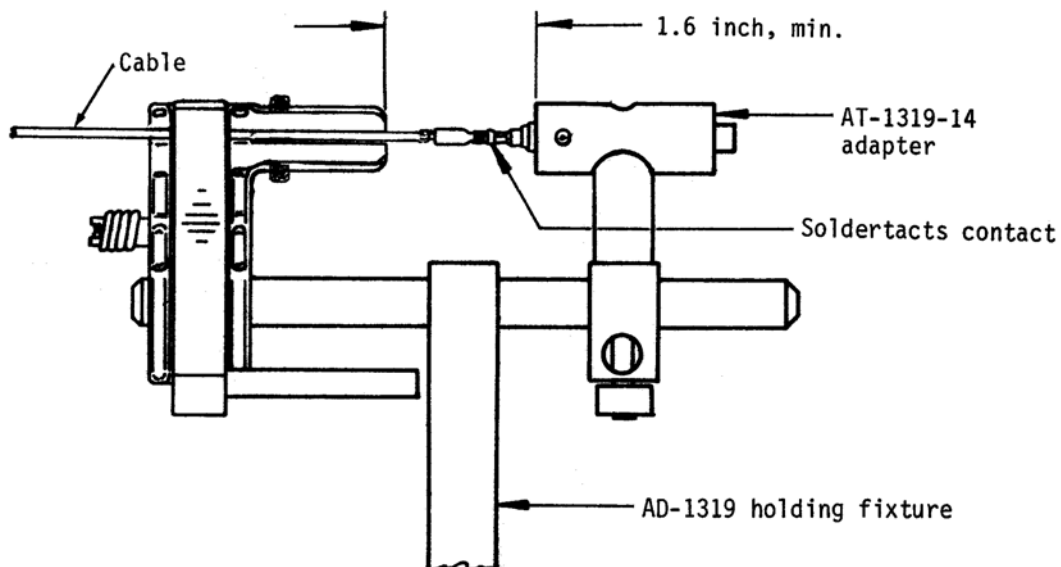

- 
5. Heat the contact until both solder preforms melt and flow, and the insulation sleeve at the rear of the contact shrinks onto the cable inner jacket.
    - \* Use the CV-5300 MiniGun with the MG-1 reflector.
    - \* Aim the hot air at the forward inspection windows first, as soon as the solder melts, aim the hot air at the rear inspection windows.
    - \* Stop heating the instant the solder has melted and flowed.
    - \* **WARNING:** The contact is hot after termination and can cause burns. Do not touch with bare hands.
  6. Allow the contact to cool for at least 15 seconds before releasing the cable clamp or disturbing the contact or cable.
    - \* **CAUTION:** Disturbing the contact too soon can result in faulty solder joints.
  7. Release the cable from the clamp and remove the terminated contact from the termination adapter.
  8. Inspect the terminated contact.
    - \* The solder preform in the forward inspection windows must be melted and flowed so that a solder fillet is visible between the cable center conductor and the inner contact soldering surface.
    - \* The solder preform in the rear inspection windows must be melted and flowed into the braid strands, and a solder fillet must be visible between the braid and the contact body.
    - \* The insulating sleeve must be shrunk onto the braid and inner jacket at the rear of the contact.
    - \* The insulating sleeve must not be darkened so as to obscure the solder joint or hinder inspection.
    - \* The cable must not show signs of damage or overheating outside of the insulating sleeve.



- 
9. Insert the terminated contact into the outer body until it locks into place.
    - \* Pull back on the contact to make sure that it is locked into the outer body.
  10. Push the contact fully into the outer body and examine the outer braid of the cable.
    - \* The outer cable braid must be positioned completely underneath the insulation sleeve at the rear of the outer body.
    - \* If any braid strands extend beyond the insulation sleeve, remove the contact from the outer body using the AD-1447 removal tool, and trim the outer braid to 0.150 inch length.
  11. Insert the contact assembly into the AT-1319-22 adapter of the AD-1319 fixture, and clamp the cable in line with the contact.
    - \* Insert D-602-1116 pin assemblies into the "P" end of the adapter.
    - \* Insert D-602-1117 socket assemblies into the "S" end of the adapter.

12. Heat the solder preform at the rear of the outer body until the solder preform melts and flows, and the insulation sleeve at the rear of the outer body shrinks onto the cable outer jacket.

- \* Use the CV-5300 MiniGun with the MG-1 reflector.
- \* Stop heating the instant the solder has melted and flowed.
- \* **WARNING:** The contact is hot after termination and can cause burns. Do not touch with bare hands.

13. Allow the contact to cool for at least 15 seconds before releasing the cable clamp or disturbing the contact or cable.

- \* **CAUTION:** Disturbing the contact too soon can result in faulty solder joints.

14. Release the cable from the clamp and remove the terminated contact from the termination adapter.

15. Inspect the terminated contact.

- \* The solder preform in the inspection windows must be melted and flowed into the braid strands, and a solder fillet must be visible between the braid and the contact body.
- \* The insulating sleeve must be shrunk onto the braid and outer jacket at the rear of the contact.
- \* The insulating sleeve must not be darkened so as to obscure the solder joint or hinder inspection.
- \* The cable must not show signs of damage or overheating outside of the insulating sleeve.
- \* Braid strands must not poke out behind the insulating sleeve.