



Raychem Cable Accessories for Nuclear Environments

Raychem
from TE Connectivity

CONTENT

General information	2
Low voltage tubing	19
End-cap kits, end-caps and breakouts	37
Low voltage splice kits (1 kV)	41
Jacket repair and insulating tapes	49
High voltage products (5 - 15 kV)	53
Commercial products and tools	61

Photo frontpage: Framatome ANP GmbH, Erlangen

General Information

General information	3
• Design	4
• Quality control	5
• Products	7
• Training	10

Qualifications for LOCA (K1)	11
------------------------------	----

General handling, storage and shipping instructions	15
---	----

Warranty	16
----------	----

Certification	17
---------------	----



Class 1E (K1) nuclear qualified LOCA type-tested cable accessories

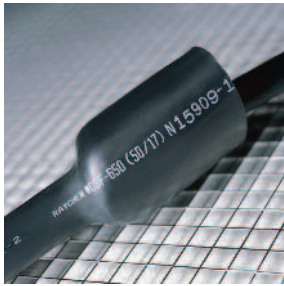

Heat-shrinkable cable accessories

TE Connectivity has developed a series of heat-shrinkable components and kits to help seal and insulate electrical connections in nuclear power plants. Made of heavy-wall, flame retardant, cross-linked polyolefin and pre-coated with a nuclear-grade adhesive, these products are designed to withstand radiation levels and temperatures attainable inside nuclear stations' containment buildings.

Our laboratories or independent certified facilities type-test all our Class 1E safety-related harsh environment products in their deployment configurations and under worst-case conditions. Test results are published in TE Energy Reports (EDR) used for EQ purposes to certify conformance and compliance.

Reformulation

Due to changes in the base polymer and flame retardant system, TE reformulated the base compounds used for extruded tubing, moulded parts and nuclear sealing adhesive. Launched in 1999, the two year project repeated the initial tests conducted for the original compounds.

The results substantiated that the two materials were essentially alike and can be considered similar in form, fit, and function.



TE nuclear power products are designed specifically to satisfy the requirements of protecting many of the 200,000 connections made in the construction of these plants. TE nuclear accessories have been subjected to very stringent LOCA/HELB tests to verify their performance capability in hypothetical nuclear accident scenarios.

Products made of the new compounds were type-tested to a LOCA that was as close to the original LOCA as could be attained. Test results confirmed that the reformulated material and the original compound are virtually the same. The new LOCA test provided the opportunity to examine some changes in our product design parameters, including a 25 mm seal length for smaller conductors and a wider application range. All these type-tests are documented in test reports, including EDR-5336 and EDR-5389.

The new design parameters are included in the in-line splice application guide in this catalogue.

Qualification

Electrical connections must be qualified to at least the same standards as cables. TE nuclear products are designed to perform in environments more severe than specified for most Class 1E LOCA-qualified cables, and are tested beyond the conditions stipulated for most nuclear power plants' design base events. Nuclear environmental qualification (EQ) for products mandates compliance with prevailing industry standards, including IEEE 323 and IEEE 383 and other international standards.

Materials used in these products have been tested and proven to perform their intended function for the service life of the plant. TE uses many accepted methods to verify life expectancy, including the Arrhenius method for accelerating plastics' aging process. These materials are then used individually as components, as tubing for simple splices and – for more complex applications – in various combinations called kits.



Design

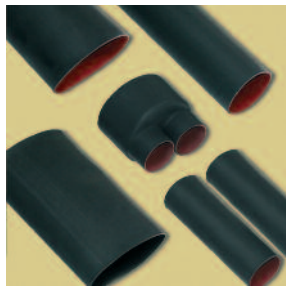

Typical kit

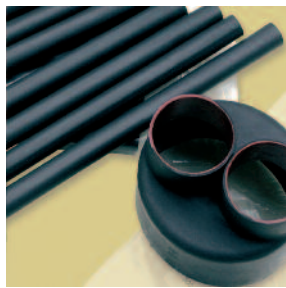

Components

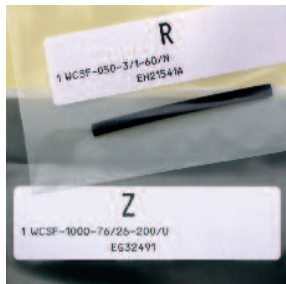

Typical label



Package

Design

Available in a variety of configurations, TE Connectivity's Raychem products are qualified for harsh environments. Designs range from very simple single-conductor splices using one type of heat shrink tubing to elaborate kits featuring several different components for cable transitions. Featuring generic designs that cover a wide range of cable types and sizes, these products have been type-tested to IEEE 383 and IEEE 323 specifications.

Note: All TE Connectivity Raychem kits are sized according to substrate diameter rather than wire cross section. The diameters of wires and cables with the same cross section may vary considerably. For this reason, it is vital to determine the qualified substrate sealing diameter when selecting kits.

A typical kit is composed of heat-shrinkable tubing and heat-shrinkable molded parts. These components combine to electrically insulate and environmentally seal a cable splice in a specific configuration. The product label indicates the kit name, functions, application range (usually the cable core insulation diameter range and bolt or connector size), voltage class, lot number and other TE ID numbers.

The kit also includes product installation instructions providing a detailed, step-by-step description of the installation procedure. This guide contains a contents list describing the kit's constituent components. Individual components are indicated by letters for easy identification and reference. Each component comes in a poly bag and is labeled with a letter referencing it to the kit contents list in the installation instructions.

Installation Instruction



Quality control

Quality control

Quality assurance procedures applied in the design and manufacture of TE Connectivity's Raychem Nuclear Cable Accessories comply with nuclear industry standards worldwide. Since 1980, the former Raychem company has pursued a quality assurance program conformant with 10 CFR 50, Appendix B, as well as several other national and international standards. Peer review of design and manufacturing processes is mandatory. TE facilities are audited by several independent audit committees, including NUPIC.



The TE Energy Quality Assurance program complies with the following standards:

- 10CFR50, Appendix B
- ANSI N45.2 (and applicable subordinate standards)
- CAN3-Z299.2
- ISO-9001

Nuclear products – typical kit documentation

Alongside supplying base components (tubing and molded parts), TE designs and manufactures a wide variety of kits serving to seal and insulate specific connections in plants. These kits offer the added benefit of foresight: They are pre-designed to ensure consistency with type-tested designs and pre-kitted with precisely the required parts.

Advantages of pre-designed kits:

- Engineering details have been established and documented.
- Documentation offers multiple checkpoints for verifying the kit's suitability.
- Traceability is given and easily maintained during installation.
- Comprehensive installation instructions offer step-by-step guidance.

Nuclear kit documentation features:

1. Each nuclear splice kit is boxed (for storage convenience) and labeled with the following information:
 - Part number (name)
 - Functional description
 - Application range (insulation diameters)

This labeling information allows the installer to confirm the given kit's suitability before opening the box.

2. Each kit comprising several components is placed in a cardboard box or in a poly bag and labeled with a kit lot number. TE logs this lot number, using it to reference the lot numbers for all the kit's components. This kit lot number can be documented in the field to facilitate traceability.
3. Each component in the splice kit is separately bagged and labeled with a key reference letter. A different letter of the alphabet is assigned to each component, and the installation instructions indicate this letter when referring to the component. This allows the installer to easily identify every part at each step of the installation procedure. Individual bagging keeps parts clean prior to installation.
4. Each kit ships with the appropriate installation instructions covering cable preparation, application method, and installation sequence. These instructions refer to components using descriptions as well key reference letters.

Products



WCSF-N cable sleeves
 (For Class 1E systems subject to LOCA/MSLB)
 WCSF-N is flame retardant, heavy-wall tubing designed for nuclear applications. Rated to 1,000 volts, it is designed to electrically insulate, mechanically protect and environmentally seal cable splices. It is coated internally with a red sealant specially formulated to withstand the rigors of the nuclear environment (uncoated tubing is available for applications that do not require environmental seals).



Nuclear plant splice kit
 (For Class 1E systems subject to LOCA/MSLB)
 Nuclear plant splice kits feature an environmentally sealed and mechanically protected electrical splice insulating system. Splice kits serve to individually splice and seal each insulated conductor and reconstitute the cable jacket over the splice area for additional protection and reliability. Nuclear plant splice kits are available to satisfy all electrical penetration splicing requirements for:

- control cables,
- power cables, and
- shielded instrumentation cables.

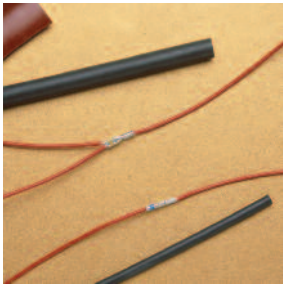

NTBR
 NTBR kits serve to insulate and environmentally seal Class 1E wires that are relatively small (1.8 to 4.3 mm using WCSF-050-3/1 up to WCSF-115-9/3). Connectors are not included. These kits have been type-tested to LOCA environments and comply with all applicable IEEE 323 and IEEE 383 specifications.

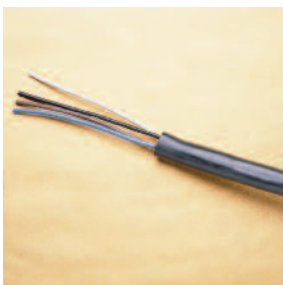

Nuclear cable breakout kit
 (For Class 1E systems subject to LOCA/MSLB)
 Nuclear cable breakout kits are designed to environmentally seal cable jackets and prevent moisture from migrating down the cable.



Nuclear end sealing kit
(For Class 1E systems subject to LOCA/MSLB)
Nuclear end sealing kits are designed to environmentally seal cable ends and spare conductors.



Nuclear plant stub connection kit (“V”)
(For Class 1E systems subject to LOCA/MSLB)
Nuclear plant stub connection kits (“V”) are designed to insulate and seal V-type stub connections to valves, limit switches, level switches and instruments in small boxes or conduit outlet bodies where installation space is very limited. They may be employed as a one-to-one replacement for terminal blocks.



Nuclear motor connection kit
(For Class 1E systems subject to LOCA/MSLB)
This product line is designed for low-voltage motor terminations. Available in stub, in-line, Y and H configurations, these kits are remarkably easy to install and remove.



Nuclear jacket repair and insulating tape
(For Class 1E systems subject to LOCA/MSLB)
These wraparound products are an excellent solution when the cable end is inaccessible. Made of the same material as WCSF-N tubing, NJRT and NWRT tapes serve to repair damaged cable jackets and replace non-qualified tape on single-conductor in-line splices for Class 1E circuits in need of repair.



Nuclear high voltage termination
(For Class 1E systems non-accident)

This product comprises a system serving to terminate and seal all types of medium voltage (5 - 15 kV) cables. Terminations have been certified for use in Class 1E circuits mandating a 40-year life span with a 500 kGy (50 Mrad) integrated radiation dose.



Nuclear motor connection kit - 8 kV
(For Class 1E systems subject to HELB)

These kits are designed to insulate and seal connections in Class 1E medium voltage motors. Offered in in-line, stub and Y configurations, kits are available to terminate all types of shielded field cables.



BBIT-N bus insulation tubing

BBIT-N is heavy-wall bus insulation tubing for use on straight or bent bars requiring reduced maximum clearance. Rated to ANSI/IEEE C37.20-1987 for 15 kV applications, BBIT-N has been tested for Class 1E insulated connections under HELB conditions.



HVBT-RN bus insulation tape

HVBT-RN is a sealant-coated, general-purpose tape used to insulate straight and bent bus bars in retrofit applications where tubing cannot be used.

Training

Training

TE offers training classes for Raychem nuclear qualified products for installers, inspectors and engineering personnel. These classes cover the basic elements of material science, heat-shrinkable polyolefin technology, specific product functions and hands-on installation. The courses are given by TE personnel and typically last eight hours (minimum).

Please do not hesitate to contact your TE sales representative or Nuclear Product Management for additional information. Detailed information is listed on the back cover of this booklet.

Typical training outline:

1. Introduction: Material properties
2. Heat-shrinkable polyolefin technology
3. WCSF tubing
4. Calculating use range and seal length
5. Product and kit documentation
6. Hands-on installation of products

There are several demo kits designed especially for training.

PDP-5

Transition splice kit with cable to demonstrate a more complex splice. Used on a shielded twisted pair instrumentation cable.

PDP-22

Bolted V-type splice configuration, for wires with small cross sections (insulated diameter 2.4 to 5.0 mm)

PDP-57

A roll of NJRT and a cable stub for demonstrating heat-shrinkable tape.

Qualifications

Qualification test reports

Report number	Type-test description	Product tested
EDR-5008	Qualification to ANSI C119.1-1974	WCSF-N
EDR-5009	Vertical tray flame test to section 2.5 of IEEE 383-1974	WCSF-N
EDR-5011	LOCA Qualification test of WCSF-N on EPR-Hypalon wire per IEEE 323	WCSF-N
EDR-5018	Life assessment including Arrhenius analysis of materials	NHVT
EDR-5021	Qualification report supplement for Raychem nuclear grade adhesive	S1119
EDR-5022	Performance test to IEEE 48-1975	NHVT
EDR-5024	Qualification report supplement	GCA
EDR-5037	HELB Qualification test after heat aging and radiation	NMCK8
EDR-5040	Arrhenius heat aging performance	-52 moulding material
EDR-5046	Arrhenius heat aging performance	WCSF material
EDR-5060	Evaluation and performance of S1119 ribbon adhesive	S1119
EDR-5063	Arrhenius heat aging performance	BBIT material
EDR-5088	One inch seal length - non-accident	WCSF-N
EDR-5190	Performance evaluation of Raychem nuclear motor connection kit - NMCK8-V	NMCK8-V
EDR-5210	WBTF/NJRT Qualification type-test	NJRT
EDR-5260	NMCK-V kits. Conversion of bonded end-caps to moulded round end-caps	NMCK
71100, Rev. 1	Performance test after thermal and radiation aging	NHVT
Franklin Inst. F-C4033-3	LOCA Qualification test per IEEE 323 and WCSF-N guidelines using simultaneous application of environmental parameters	WCSF-N
Wyle Laboratories 58442-1,-2 & -3	LOCA/MSLB Qualification test per IEEE 323 and 383 guidelines	1: WCSF-N 2: NCBK,NESK 3: NMCK
Wyle Laboratories 58722-1,-2,-3,-5,-6	LOCA/MSLB Qualification test per IEEE 323 and 383 guidelines	1: NPKV 2: WCSF-N (bolted splice) 3: 202B811 & 821 moulded sleeve 5: WCSF-050N 6: NPKV
AT/E 1029 & 1061	LOCA Qualification test after thermal and radiation aging	NTMS

Qualification 2001

The original Raychem Nuclear Grade products used a compound formulation created in the late 1970's. In compliance with our Quality Assurance program, the compound formulation did not deviate from the one used to qualify the products in the 20+ years of the product's lifetime. The Qualification 2001 reformulation was designed to be as close to the original formulation as possible, using more contemporary compounds. The type-testing of the products produced with this new formulation was designed to be very similar to the original testing to allow TE to state that these products are the same in FORM, FIT, and FUNCTION as those that were qualified in the original test. The following table lists examples of the original compound formulation of Raychem Nuclear Products and the new, similar but distinctive nomenclature for the Qualification 2001 products made with the new formulation:

Typical example

Original Raychem product	Qualification 2001 Raychem product	Function
302A812-52/144	302A812-52/144-N	Cable breakout
WCSF-050-xN	WCSF-050-3/1-x/N	Heat-shrink coated tubing
WCSF-050(3/1)-x/144		

At the advice of our customers, we chose for the Qualification 2001 nomenclature that was similar to that for the original formulation yet identifiable upon inspection. The Qualification 2001 products have different qualification reports certificates of conformance, and compliance documents that should be reviewed by the plant's engineering personnel responsible for environmental qualifications.

The Qualification 2001 project clearly showed the similarity of the parts that were manufactured with the new formulation compound and clearly provided support for the claim of equivalency in FORM, FIT, and FUNCTION.

Qualification 2001 - products test reports

EDR-5331	Analysis of heat aging data to determine aging conditions for WCSF, WBTF, and WWTF nuclear qualification testing	All extruded products WCSF, NJRT & WBTF tapes
EDR-5332	Analysis of heat aging data to determine aging conditions for -52 molding material for nuclear qualification testing	All moulded parts, end caps, and breakouts
EDR-5336	Nuclear products requalification testing	Type-testing for WCSF and all kitted products, except kitted products with moulded end caps
EDR-5348	Flammability qualification test report: IEEE 1202 (IEEE 383)	Flame retardency test for new compound (old IEEE 383 test)
EDR-5389	Nuclear products requalification testing, phase 2	Type-testing for kitted products containing moulded reformulated end caps

Wyle 58442

The following is a brief summary of TE Environmental Qualification Test Reports 58442-1, -2, and -3. These reports document the results of the qualification type-testing that was conducted at Wyle Laboratories in Norco, California.

Test sequence

1. Thermal aging to simulate 40 years at 90 °C (1500 hours at 150 °C - based on Arrhenius plot).
2. Radiation exposure, 2000 - 2900 kGy (200 - 290 Mrad) gamma radiation.
3. Simulated LOCA/MSLB environmental exposure with samples energized at 1000 Volts and rated current.
4. Chemical spray continuously for 30 days (6200 ppm boron, 50 ppm hydrazine, trisodium phosphate buffer to pH of 10.5).

Test summary

1. WCSF-/N, NMCK, NCBK and NESK products met the defined acceptance criteria in qualification type-testing.
2. Products tested were fully exposed to a LOCA/MSLB environment, including chemical spray. No protective enclosure required.
3. Product test configuration verifies insensitivity to orientation.
4. Electrical function monitored before during, and after environmental testing. All voltage withstand tests conducted at 3600 Volts AC for 5 minutes with samples immersed in water.

Wyle 58722

The following is a brief summary of TE Raychem Environmental Qualification Test Reports 58722-1, -2, -3, -5 and -6. These reports document the results of the qualification type-testing conducted at Wyle Laboratories in Norco, California.

Test sequence

1. Thermal aging to simulate 40 years at 90 °C (916.75 hours at 150 °C - based on Arrhenius plot), EDR-5046.
2. Radiation exposure, 2200 kGy (220 Mrad) gamma radiations.
3. Simulated LOCA/MSLB environmental exposure with samples energized at 1000 Volts and rated current.
4. Chemical spray continuously for 30 days (6200 ppm boron, 50 ppm hydrazine, trisodium phosphate buffer to pH of 10.5).

Test summary

1. WCSF-/N, NPKV, moulded sleeves, WCSF-050-N and NPK products met the defined acceptance criteria in qualification type-testing.
2. Products were fully exposed to LOCA-MSLB environment including chemical spray. No protective enclosure required.
3. Product test configuration verifies insensitivity to orientation.
4. Electrical function monitored before, during and after environmental testing. All voltage withstand tests conducted at 3600 Volts AC for 5 minutes with samples immersed in water.

EDR-5336, EDR-5389

The following is a brief summary of TE Raychem Qualification 2001. This report documents the result of the testing done to verify that the cable accessories and components manufactured with the new compound are the same in FORM, FIT, and FUNCTION as the original formulation components. The type-testing was conducted at the Wyle Laboratories in Huntsville, Alabama.

Test sequence

1. Thermal aging to simulate 40 years at 90 °C (878 hours at 150 °C - based on Arrhenius data) and 60 years at 90 °C (1379 hours at 150°C - based on Arrhenius data). Both original and new formulations were used in these thermally aged samples.
2. Radiation exposure, up to 2180 kGy (218 Mrad) gamma radiation.
3. Simulated LOCA/MSLB environmental exposure with samples energized according to 600 V with rated current.
4. Chemical spray continuously for 30 days (0.28M H₃BO₃, 0.064M Na₂S₂O₃ buffered with NaOH to pH of 10.5).

Test summary

1. All products were shown to be equivalent in FORM, FIT, and FUNCTION to original products.
2. Kits configured from combinations of original components with new components performed the same as kits configured with all new formulation components.
3. Reduced seal lengths of 25 mm were tested on small conductor samples. 25 mm seal lengths shown to pass the entire test sequence.
4. The use range criteria have been expanded from 2.0 times the extruded ID of the tubing to 2.5 times.

Note: This information is provided as a summary only. Check with TE local sales representative for current revisions of all test reports when performing environmental qualification analysis.

General handling, storage and shipping instructions

General handling

TE Energy nuclear cable accessory products are packaged in accordance with TE Packaging Specification 107-18064.

Packed in accordance with these instructions, these products will be adequately protected from normal physical damage and contamination while in transit (truck, rail, air, boat) where good commercial shipping practices are utilized and while in storage.

There are no shelf life limitations for TE nuclear products when stored under the conditions described below.

This statement does not extend the warranty period beyond the period set forth in the TE Raychem General Supply Terms and Conditions for International Business.

Packaging

Internal packaging consists of polyethylene bag, (tie or heat sealed), providing protection against dirt, water, salt and other contaminants. Single-unit packaging (for an entire kit or for a single component, whichever is applicable) is normally specified by TE; however, certain items such as tubing or small items may be bulk packaged at a specific quantity. The bags are placed in cardboard boxes to provide protection from physical damage.

Quantities may be single unit or bulk quantities per box. Cushioning material is not required although styrofoam or paper cushioning materials may be utilized in shipping boxes to prevent shifting.

Identification

Product identification is accomplished by labelling the internal and cardboard containers. The labels contain, at a minimum: TE company name, product description or part number, lot control number and quantity. Other information useful to the user may also be provided.

Shipping

Packaging described above is for most shipping situations. Large shipments may be consolidated into large cardboard containers or palletized and shrink-wrapped. Shipping boxes or containers are marked with with a "Ship to" address, PO number, and TE order number. Additional information (such as "Storage Level", PO item numbers, special marking, etc.) may be added to containers when required. Sound material handling practices which prevent physical damage to the product packaging are sufficient for TE Energy products.

Storage

Indoor storage is recommended to avoid excessive exposure to dirt, water, salt, that may cause packaging to deteriorate or contaminate the product.

Storage temperatures must be within the range of -40 to 60 °C.

Warranty

Warranty

TE warrants that the product supplied hereunder will be free from defects in materials and workmanship and shall conform to applicable TE specifications at the time of shipment. TE does not warrant the use by Buyer of any product or component for a particular application except as specified or approved in advance by TE in writing, and assumes no responsibility for any field engineering or documentation prepared by Buyer. TE will supply replacement product for any product not conforming to the above warranty within 12 months of the date of shipment. In no event will TE be liable for any incidental or consequential damages including, without limitation, removal of a defective product or installation of a replacement product. The foregoing warranty is in lieu of any other warranty including, without limitation, any warranty of merchantability or fitness for a particular purpose, any and all of which are hereby expressly disclaimed.

Limitation of liability; indemnity

Notwithstanding any other provision herein, or in any other document or communication, (i) Seller's liability with respect to any matter or matters resulting from, or arising from, or relating to this purchase order, shall in no event exceed in the aggregate the total purchase price of the particular goods purchased hereunder from, or to which the liability results, arises or relates, and (ii) Seller shall in no event be liable to Buyer, Engineer, or any other person or entity for loss of use of Buyer's or its customer's facilities, loss of revenue, loss of use of revenue, loss of anticipated profits, cost of replacement power, or other incidental or consequential damages. By accepting delivery of the products offered, Buyer agrees that it indemnifies and holds harmless Seller against all claims, loss damage, and liability including without limitation whatever kind, directly or indirectly arising from or relating to the hazards inherent in the Buyer's or its customer's facilities.

Suitability

It is the responsibility of the Buyer to determine, on the basis of test reports furnished with the bid, or before fabrication, the suitability of the goods for the intended use and their compliance with applicable codes and standards.

Notification

It is the responsibility of the Buyer to notify TE of a product defect within 30 days of its discovery, including a brief summary describing the nature of the defect and the degree of urgency generated by the situation. Notification shall be written, must be addressed or transmitted by fax to the Nuclear Product Management, TE Raychem GmbH, Ottobrunn/Munich, Germany. Detailed information is listed on the back cover of this booklet.

Certification

All nuclear qualified products will be supplied with a Certificate of Compliance/Conformance.

The following page depicts an example of the Certificate of Compliance/Conformance that will be provided with the extruded WCSF products.

Tyco Electronics Raychem GmbH
 Energy Division
 Finsinger Feld 1
 85521 Ottobrunn, Germany

Customer Order No.:
 Factory Order No.:
 Date:

CERTIFICATE OF COMPLIANCE/CONFORMANCE
 (Certificate of Compliance When Test Reports are Attached)

THIS CERTIFIES THAT THE ITEMS LISTED BELOW, WHEN INSTALLED IN ACCORDANCE WITH THE MANUFACTURER'S INSTALLATION INSTRUCTIONS:

1. Are identical, in respect to original material processing, and design basis criteria, to those products tested in the following reports:

- EDR-5348*: Flammability Qualification Report [Ref: IEEE 1202 (IEEE-383)], Rev. 0, dated: February 11, 2002
- EDR-5331*: Arrhenius Aging Report (Ref: IEEE-383, Sec. 2.3.2), Rev. 0, dated: September 21, 2000
- EDR-5336*: DBE Qualification Report (Ref: IEEE-383, Sec. 2.4), Rev. 3, dated: May 01, 2003
- EDR-5389*: Nuclear Products Requalification Testing Phase 2, Rev. 0, dated: December 10, 2004

Notes: Some of the above reports evaluated adhesive coated sleeves. If sealing is required, coated sleeves (WCSF-N) should be used.

(Reports marked with an asterik (*) comply with IEEE Standards 323-1974 and 383-1983.

The determination of suitability for specific end uses of these products is the responsibility of the purchaser.)

2. Are in conformance with the following specification:

QCTS E184

In conformance with the requirements of the above stated purchase order.

3. Have no shelf life limitations when stored in accordance with ANSI N45.2.2 level B or C;

Temperature range: - 40 to +140 °F (- 40 to +60 °C)

4. And are being supplied in accordance with the Tyco Electronics Raychem GmbH, Energy Division Ottobrunn, Germany Quality Manual, Rev. 5, December 2002, which complies with 10CFR50, Appx. B, 10CFR21, NQA-1, ANSI N45.2 (and applicable "daughter" Standards), CAN3-Z299.2 and ISO-9001.

Records supporting this certificate are kept on file and are available for review at Tyco Electronics Raychem GmbH, Energy Division, D-85521 Ottobrunn Finsinger Feld 1, Germany.

 Quality Assurance Manager

ITEM	PRODUCT DESCRIPTION	LOT NUMBER	QUANTITY
1	WCSF-070-6/2-100/N		xxxxxx 50

Note: These products have not been fabricated, tested, or packaged with mercury or mercury compounds.

EXCEPT AS OTHERWISE EXPRESSLY AGREED BY TYCO/ELECTRONICS IN WRITING, THE FOREGOING CERTIFICATE IS IN LIEU OF ANY WARRANTY OR REPRESENTATION EXPRESSED OR IMPLIED, INCLUDING WITHOUT LIMITATION ANY WARRANTY OF MERCHANTABILITY OR FITNESS FOR A PARTICULAR PURPOSE, BOTH OF WHICH ARE EXPRESSLY DISCLAIMED.

Low Voltage Tubing

WCSF - Heat-shrinkable tubing	20
-------------------------------	----

WCSF - In-line splice application guide	24
---	----

Installation and inspection guidelines	31
--	----

Accessories	
• Braided sleeving for nuclear applications	32
• Roll spring	33



WCSF – Heat-shrinkable heavy-wall flame-retarded tubing for nuclear environments



WCSF tubing is a heavy-wall, flame-retarded, heat-shrinkable tubing. It is pre-coated with a hot melt, radiation-resistant adhesive to provide a positive environmental seal. It is designed to provide electrical insulation up to 1000 V and for general purpose sealing applications where flame retardancy, radiation resistance, and severe environmental performance are required.

WCSF tubing is suitable for a wide range of joining or connection applications for Class 1E wire and cable systems in accordance with IEEE 383. Each connection is individually insulated and sealed. Additionally, the tubing can also be used for a wide range of related applications including sealing, over-sheath replacement, and strain relief throughout the plant. WCSF tubing can also be supplied as components of kits for specific applications.

The heat-shrinkability of TE WCSF tubing facilitates fast and easy installation, positive visual inspection, and a pre-engineered insulation thickness to assure consistent installation.

WCSF tubing is supplied under TE comprehensive quality assurance programme with certified documentation to meet industry requirements for safety related electrical equipment.

Qualification type-testing

The WCSF-/N tubing has been subjected to the following tests:

Flammability

The product passed the IEEE 1202, Section 7.2 (IEEE 383) Flame Test at both 70,000 and 210,000 BTU/hour. (Test report EDR-5348)

Heat aging

40-year life at 90 °C established using the Arrhenius method. (Test report EDR-5331)

LOCA

WCSF tubing has been tested to LOCA/HELB profiles based on the guidelines of IEEE 323 and 383-1974 (test report EDR-5336).

Key test parameters include:

- 40 and 60 year thermal aging at 90° C
- 2180 kGy (218 Mrad) radiation exposure
- 30 day LOCA test
- 30 day chemical spray
- Double peak profile with:
 - max. temperature 218 °C
 - max. pressure 8 bar

TE’s environmental type-tests are valid when sleeves are used within the established ranges specified in the product installation and inspection guide. Use of the product beyond these ranges may invalidate the applicability of these test results.

Qualification

Individual qualification tests for specific customer applications are the responsibility of the user.

Ordering information

Order by part number. Specify size and coating.

Type -/N for nuclear adhesive coating. Coated tubing not available on spools. Type -/U uncoated tubing is available if a seal is not required. Spooled, uncoated tubing is designated -A/U.

Related product information material specifications

PPS 3010/7 (RT-1508/1) – Tubing
 PPS 3012/19 (RT-1050/15)– Adhesive/sealant

Qualification test reports:

- EDR-5331
- EDR-5336
- EDR-5348
- EDR-5389

Typical WCSF material properties

WCSF properties		Test method	Requirement	
Tensile strength		ISO 37	8.2 N/mm ² min.	
Ultimate elongation		ISO 37	250 % min.	
Density		ISO 1183/3 method A	1.35 g/cm ³ max.	
Accelerated aging	200 h at 175 °C	ISO 188		
	1600 h at 150 °C			
	Tensile strength			ISO 37
	Ultimate elongation	ISO 37	100 % min.	
Low temperature flexibility	4 hours at -55 °C	ASTM D2671 procedure C	no cracking	
Flammability		ICEA S-19-81 Sec. 6. 19.6	self-extinguishing in <1 min	
Dielectric strength	nominal wall thickness 2.5 mm	IEC 60243/1+2	75 kV/cm min.	
Volume resistivity		IEC 60093	1 x 10 ¹³ ffcmin.	
Water absorption		ISO 60062	< 0.5 % after 24 h at 23 ° ± 2 °C	
Corrosive effect	16 h at 135 °C	ASTM D2671 procedure A	no corrosion	
Heat aging and radiation	200 h at 175 °C followed by 50 Mrad gamma-radiation (0.5 - 1.0 Mrad/h) followed by:		Raychem internal test method	
		Tensile Strength	ISO 37	5.5 N/mm ² min.
		Ultimate Elongation	ISO 37	50 % min.
Additional properties	Further details are given in Raychem specification PPS 3010.			

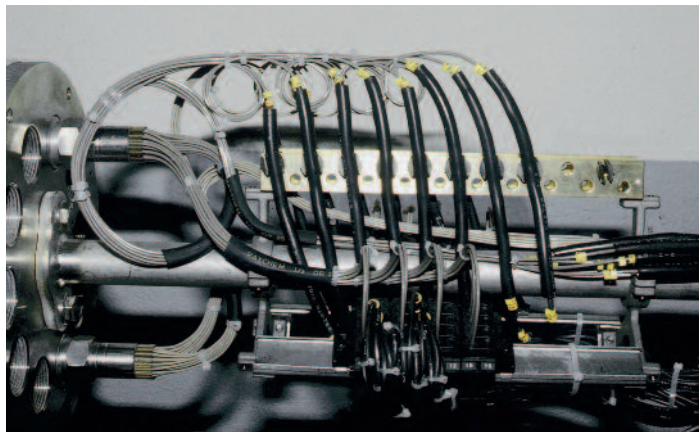

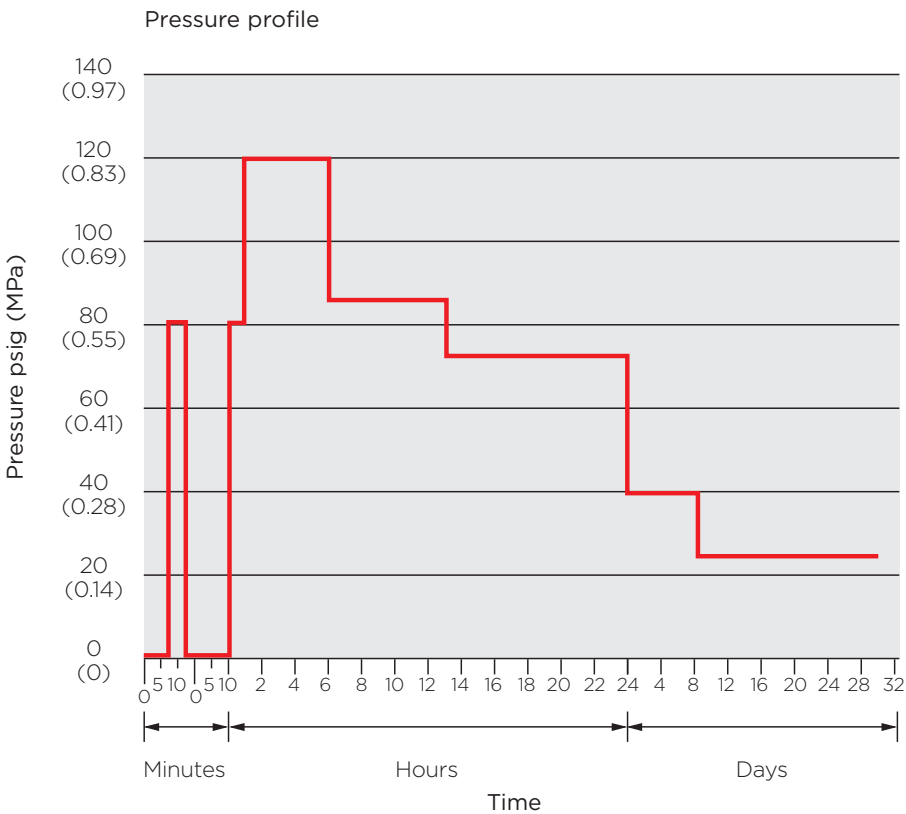
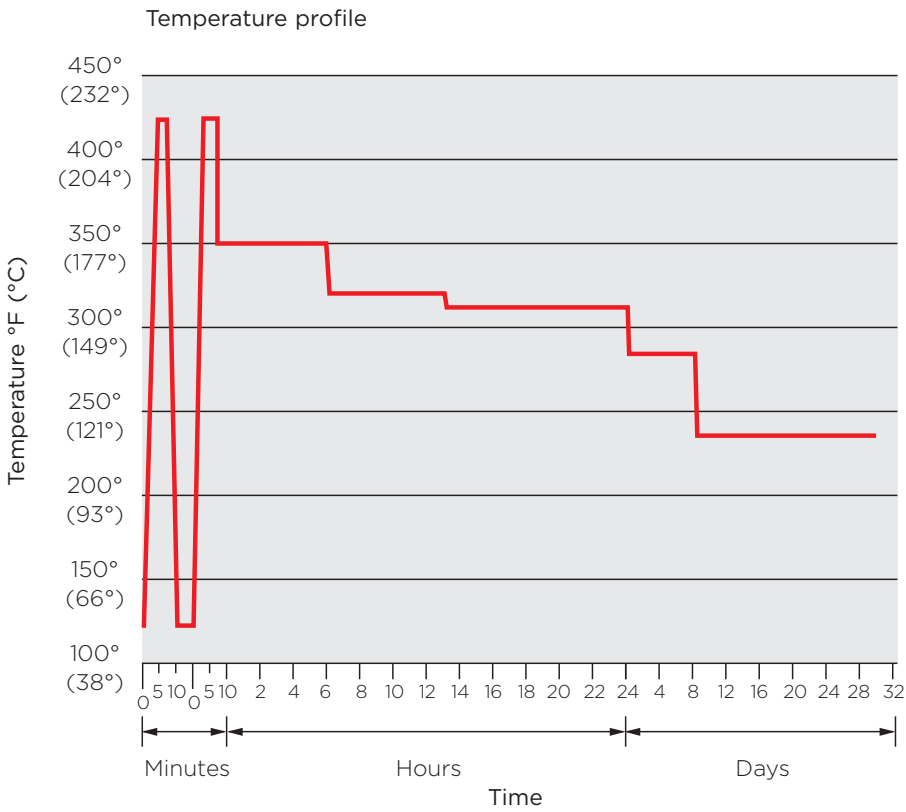

Ordering information

The Qualification 2001 WCSF tubing has expanded use ranges and different descriptions from the original formulation WCSF products. There is only one use range (the minimum and maximum qualified substrate diameter allowed for compliance with the type-testing).

**Ordering example
Standard length**

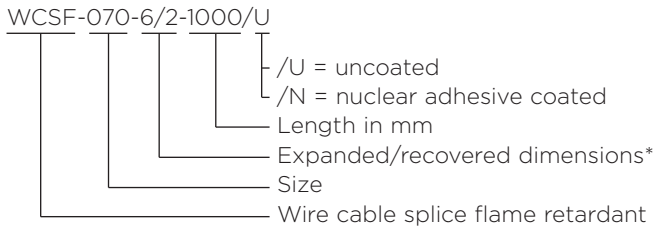

**Ordering example
Spool/uncoated**

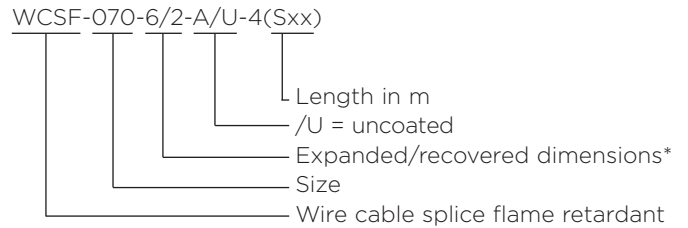

Description	Standard cut length (mm)	Length on spool (uncoated only) (meter)	Use range (mm) min. - max.	Note
WCSF-050-3/1	1000	30	1.3 - 1.8	1) 2) 3)
WCSF-070-6/2	1000	30	1.8 - 4.4 (3.6)*	1) 2)
WCSF-115-9/3	1000	30	2.9 - 7.3 (5.8)*	1) 2)
WCSF-200-18/5	1000	30	5.1 - 12.7 (10.2)*	1) 2)
WCSF-300-28/8	1000	15	7.9 - 19.0 (15.2)*	1)
WCSF-500-38/13	1000	15	14.0 - 32.0	1)
WCSF-650-50/17	1000	12	18.0 - 41.0	1)
WCSF-1000-76/26	1000	9	28.0 - 64.0	
WCSF-1500-114/38	1000	9	43.0 - 97.0	
WCSF-2500-177/63	1000	9	70.0 - 159.0	

() *Maximum use range over bolted connections.

- 1) Fiberglass bolt pads are required for bolted connections in all cases. Recommended bolt pad is EPPA-109N sized as needed.
- 2) These tubings can be used as splice insulation sleeve and are qualified with 25 mm seal length. All others require 50 mm seal length.
- 3) When used as a shim or small wire jacketing the use range of WCSF-050-3/1 is 1.3 - 2.5 mm.

Standard lengths and coatings

Other lengths on request.
All lengths subject to standard cutting tolerances.
Coated tubing not available on spools.

Notes:

Longitudinal change after free recovery: +0 % to -10 %.
The application range is for applications subject to high temperature accident conditions such as LOCA or HELB.
Raychem WCSF tubing is supplied complete with installation instructions.

For further details on this product or any other TE Raychem products please contact your local sales representative.

WCSF – In-line splice application guide

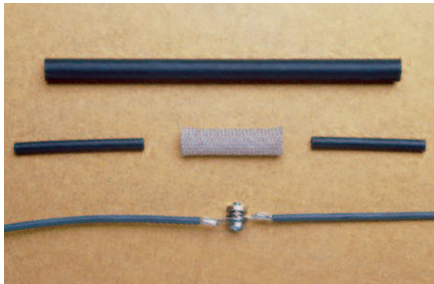

General instructions

WCSF tubing can be identified by the letters “WCSF”, on the black outer surface and the presence of a red sealant coating on the inner surface for coated tubing. There is a lot number on the outer surface for traceability.

Qualification type-tests are valid when the tubing is used in accordance with the instructions and the application ranges included in this document. Use of the product outside the published use ranges may invalidate the applicability of the qualification type-tests.

TE products are designed to seal on qualified cable insulations. It is the responsibility of our customers to insure that the critical environmental sealing surfaces are qualified (by the cable manufacturer). Several cable constructions utilize a non-qualified, sacrificial jacket for mechanical protection. It is imperative that TE nuclear qualified splicing products are installed such that the environmental seal is made on a qualified substrate.

Application guide introduction

WCSF tubing are heat-shrinkable, flame-retardant, flexible polyolefin tubing specially formulated and tested to withstand the particular environment found in nuclear generating stations. The tubing may be supplied in either “coated” or “uncoated” form. When coated, the suffix “/N” is added to the part designator indicating that the entire inner surface of the tubing is covered with a sealant that is designed to form an environmental seal under normal and Design Basis Event (DBE) conditions. Uncoated tubing carry the suffix “/U”.

The WCSF tubing series is rated to 1000 volts. This tubing has been type-tested and has demonstrated a 40-year service life at 90 °C continuous operating temperature (using Arrhenius analysis method). It has also demonstrated a 60-year service life at 90°C continuous operating temperature (using Arrhenius analysis method) to meet the requirements of future nuclear power plants. Customers should review all type-testing and qualification reports.

The purpose of this guide is to

pre-sent all of the information required to select, install, and inspect WCSF-series tubing for use on single-conductor, in-line splices only.

Qualification type-testing

Tyco Electronics has performed environmental qualification type-testing with WCSF-/N tubing in accordance with the guidelines of IEEE Std. 323-1974 and IEEE Std. 383-1974, to enable the user to qualify WCSF-/N for use on Class 1E electrical systems subject to accident conditions at nuclear power plants.

TE’s qualification type-tests are valid when the tubing is used in accordance with the guidelines and the application ranges specified in this document. Use of the product outside the published use ranges may invalidate the applicability of the qualification tests.

The qualification status of TE’s nuclear products is conditional on the substrate materials being capable of maintaining physical and seal integrity under the same conditions to which the TE materials are type-tested. It is also required that the cable substrates to which Tyco Electronics products are applied be clean and degreased and be suitable sealing surfaces (woven jackets or braids, for example, are unacceptable sealing surfaces).

TE maintains a quality assurance/quality control program in accordance with 10CFR50 Appendix B. Lot numbers are assigned to all nuclear components to enable complete traceability of our products.

Selection of tubing

The general design philosophy of heat-shrinkable cable splices is to provide adequate insulation over the exposed conductor and connection hardware with a material that provides mechanical protection and an environmental seal. The wire and cable splice is designed to perform as well as the cable in the conditions anticipated in nuclear power plant areas that are subject to Design Basis Event environments. To comply with the designs of the products that were type-tested for Class 1E and K1 harsh environments, TE's Raychem heat-shrinkable cable splice designs must meet the following criteria:

1. Tubing must be used within the published "use range" minimum and maximum diameter when sealing on qualified substrates.
2. Connectors and other hardware (bolts, nuts and lugs) must be sized not to exceed the maximum diameter use range for a given tubing. It is not required that connectors and hardware stay within the minimum diameter of use range.

3. Splices must be designed to provide type-tested seal length on the qualified substrate after installation. This is either 25 mm for WCSF-200-18/5-x/N and below or 50 mm for WCSF-300-28/8-x/N and larger tubing. This criteria applies to shims as well.

For general single-conductor wire-to-wire splices, the tubing is selected by determining the outside diameter of the qualified insulation (substrate) on each wire and the actual or effective diameter over the crimp or bolted connection hardware. The diameters of the substrate and the connector or connection hardware must fall within the "use range" of the WCSF-/N tubing selected for the splice. After the correct size of tubing is selected, the length of the splice must be determined. The length of the splice is calculated by adding the connector length (with any exposed conductor included) plus two times the required seal length plus an allowance for longitudinal or linear shrinkage of the tubing. For WCSF-050-3/1, WCSF-070-6/2, WCSF-115-9/3 and WCSF-200-18/5 the tubing have been type tested with a 25 mm seal length; tubing WCSF-300-28/8 and larger were tested with a 50 mm seal length.

Use range table

Description	Use range (mm)		K Factor to determine tubing OD
	min.	max.	
WCSF-050-3/1	1.3 - 1.8*		7.8
WCSF-070-6/2	1.8 - 4.4	(3.6)**	28.1
WCSF-115-9/3	2.9 - 7.3	(5.8)**	42.0
WCSF-200-18/5	5.1 - 12.7	(10.2)**	76.0
WCSF-300-28/8	7.9 - 19.0	(15.2)**	173.0
WCSF-500-38/13	14.0 - 32.0		298.0
WCSF-650-50/17	18.0 - 41.0		366.0
WCSF-1000-76/26	28.0 - 64.0		521.0
WCSF-1500-114/38	43.0 - 97.0		728.0
WCSF-2500-177/63	70.0 - 159.0		1158.0

* When used as a shim or small wire jacketing the use range of WCSF-050-3/1 is 1.3 - 2.5 mm.

()** Maximum use range over bolted connections.

Standard lengths 1000 mm. Other lengths on request. All lengths subject to standard cutting tolerances.

EXAMPLE 1: Qualified wire with crimped connector:

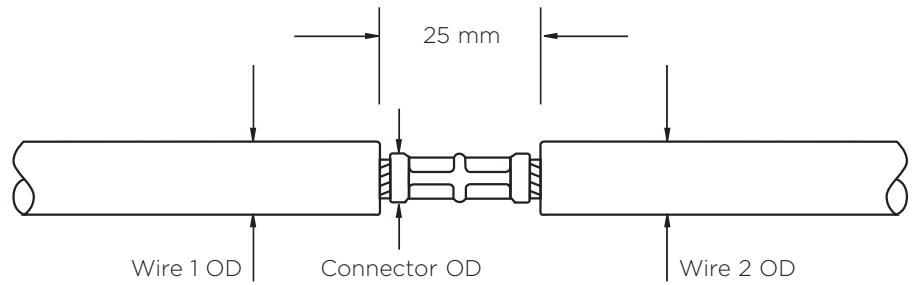

Step 1: OD of qualified substrate of Wire 1: 5.3 mm
 OD of qualified substrate of Wire 2: 5.3 mm
 OD of connector (before crimping): 2.8 mm

Step 2: Select tubing that has use range to accommodate both connector and wires:

In this example, both WCSF-115-9/3 and WCSF-200-18/5 would work; both tubing can be used with a 25 mm seal length. Note that the OD of the connector is below the use range minimum for both tubing; this is acceptable since the tubing is not making a seal on this surface.

Step 3: Calculate the length of tubing required:

Using WCSF-115-9/3-x/N

Seal length: 25 mm for each side
 Connector exposed area: 25 mm
 Length shrinkage: 10 % max.

$$\text{Total seal length} = \frac{25 \text{ mm} + 25 \text{ mm} + 25 \text{ mm}}{0.9} = 83.3 \text{ mm}$$

Total seal length = 83.3 mm minimum,
 recommended at least 100 mm.

Order description: WCSF-115-9/3-100/N

EXAMPLE 2: Two different size qualified wires with crimped connector:

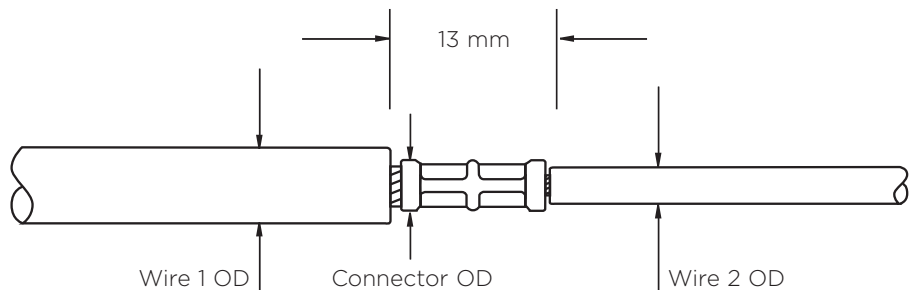

Step 1: OD of qualified substrate of Wire 1: 4.8 mm
 OD of qualified substrate of Wire 2: 1.8 mm
 OD of connector (before crimping): 3.0 mm

Step 2: Select tubing that has a use range that accommodate both connector and wires:

In this case, there is no tubing that will cover the use range of both Wire 1 and Wire 2. First select a shim tubing that will fit the smaller Wire 2 and then use the following formula to calculate the outside diameter of this installed shim tubing:

$$\text{Tubing OD} = \sqrt{(\text{OD}_{\text{substrate}})^2 + K_{\text{tubing}}}$$

Where:

Tubing OD = the outside diameter of the recovered tubing (shim)

OD substrate = the outside diameter of cable (Wire 2)

K tubing = the factored cross sectional area of the tubing given in the table of use ranges (page 3)

In this example, WCSF-070-6/2 will work for Wire 2 since the diameter is within the use range of 1.8 - 4.4 mm. Using the formula above, the OD over this shim after it is installed on Wire 2 is calculated as follows:

$$\text{Shim OD} = \sqrt{(1.8_{\text{substrate}})^2 + 28.1}$$

$$\text{Shim OD} = 5.6 \text{ mm}$$

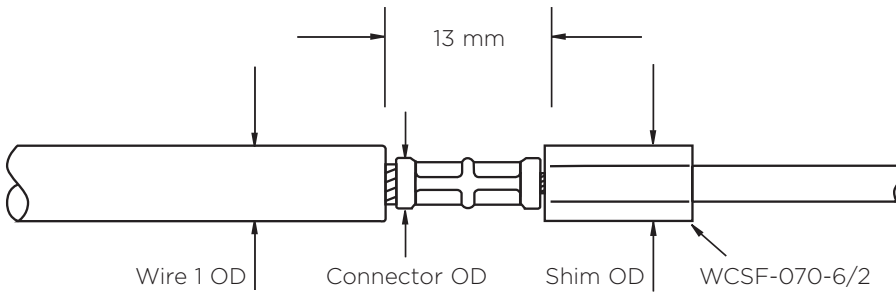

The shim length should be at least 30 mm long to comply with the seal length parameters (25 mm minimum seal length, 10 % longitudinal shrinkage).

After installation of the shim, the cables have effective diameters of

- OD of qualified substrate of Wire 1: 4.8 mm
- OD over shim on Wire 2: 5.6 mm
- OD of connector (before crimping): 3.0 mm

From these data, we can select WCSF-115-9/3 tubing and satisfy all of the use range criteria.

Step 3: Calculate the length of tubing required:

Using WCSF-115-9/3

Seal length: 25 mm for each side
 Connector exposed area: 13 mm
 Length shrinkage: 10 % max.

$$\text{Total seal length} = \frac{25 \text{ mm} + 25 \text{ mm} + 13 \text{ mm}}{0.9} = 70 \text{ mm}$$

Total seal length = 70 mm minimum,
 recommended at least min. 75 mm.

Order description: WCSF-070-6/2-30/N
 WCSF-115-9/3-75/N

EXAMPLE 3:

Qualified wire with bolted hardware connection:

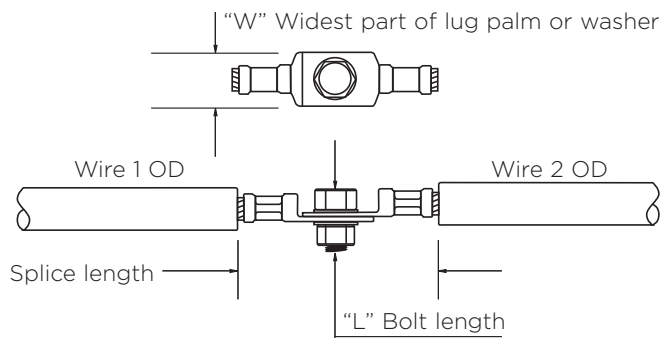

Step 1: Measure the effective diameter over the bolted connection by using a string to measure the largest part of the connection and dividing by π (3.14) to determine the diameter, or as an approximation, use the following formula:

$$\text{Diameter}_{\text{effective}} = 0.36 \times W + 0.64 \times L$$

Where:

W = Largest width dimension of lug pad or largest washer
 L = Bolt length including bolt head (this is not the commercial bolt size; it must be measured)

OD of qualified substrate of Wire 1: 5.3 mm
 OD of qualified substrate of Wire 2: 5.3 mm
 Splice length: 75.0 mm
 Length of bolt "L": 21.6 mm
 Width of lug pad "W": 19.1 mm

$$\text{Diameter}_{\text{effective}} = (0.36 \times 19.1 \text{ mm}) + (0.64 \times 21.6 \text{ mm})$$

$$\text{Diameter}_{\text{effective}} = 20.7 \text{ mm}$$

In this case, there is no tubing that will cover the use range of both the effective diameter of the bolted connection and Wires 1 and 2. First select a tubing that will fit both wires and then calculate the outside diameter of this installed "shim" tubing as before:

$$\text{Tubing OD} = \sqrt{(\text{OD}_{\text{substrate}})^2 + K_{\text{tubing}}}$$

OD substrate = 5.3 mm so use WCSF-200-18/5, K = 76.0
 The shim length should be at least 30 mm long to comply with the seal length parameters.

$$\text{Shim 1 - OD} = \sqrt{(5.3 \text{ mm}_{\text{ substrate}})^2 + 76.0}$$

Shim 1 - OD = 10.2 mm

There is no tubing that has a use range that can accommodate both the shimmed wires and the larger diameter of the bolted connection, so another shim must be installed over the first shim. Calculate the new diameter in the normal manner, using the Shim 1 - OD as the new substrate OD:

OD substrate = 10.2 mm so use WCSF-300-28/8, K = 173.0

$$\text{Shim 2 - OD} = \sqrt{(10.2 \text{ mm}_{\text{ substrate}})^2 + 173.0}$$

Shim 2 - OD = 16.6 mm

Step 2: Select tubing that has use range to accommodate both the connector and the wires:

OD of qualified substrate of Wire 1: Shimmed to 16.6 mm
 OD of qualified substrate of Wire 2: Shimmed to 16.6 mm
 Diameter effective (of bolted connection): 20.7 mm
 Splice length: 75.0 mm

Now the wires and the effective bolted connection diameter are within the use range of one tubing, WCSF-500-38/13-x/N which should be installed to overlap the outer shims on Wire 1 and 2 and over the bolted connection. The bolted connection should be covered with a fiberglass bolt pad, EPPA-109N-1 before the WCSF-500-38/13-x/N is installed, to eliminate the sharp edges of the bolt and lugs.

When two shims are necessary, the larger diameter outer shim should be calculated at least 60 mm in length in order to comply with the seal length criteria. Calculate the smaller diameter inner shim at least 15 mm longer than the outer shim. Install the outer shim so that it is centered over the inner shim.

The splice sealing sleeve must be long enough to provide proper seal length and must overlap the outer shim(s) by at least -7 mm.

Step 3: Calculate the length of sealing sleeve tubing required

Shim 2 length: 60 mm on each side = 120 mm
 Centering outer shim over inner shim
 -7 mm from the edge of the inner shim: -7 mm on each side = 15 mm
 Sealing sleeve overlap at ends of
 outer shim: -7 mm on each side = 15 mm
 Splice length: 75 mm
 Length shrinkage: 10 % max

$$\text{Total seal length} = \frac{120 \text{ mm} + 15 \text{ mm} + 15 \text{ mm} + 75 \text{ mm}}{0.9} = 250 \text{ mm}$$

Total seal length = 250 mm minimum,
 recommended at least 300 mm.

Order description: WCSF-200-18/5-75/N
 WCSF-300-28/8-60/N
 WCSF-500-38/13-300/N

Kit calculation

Wire or cable type:	Voltage class:
Wire or cable construction and dimension:	
Connection:	
Calculation:	
Order Description:	

Installation guidelines

1. Clean all qualified substrates with solvents and materials approved by the cable manufacturer before installing TE's Raychem products. Remove all non-qualified materials (such as braided materials or extra jackets) from the qualified substrate in the splice area.
2. If directed to do so, place all of the components on cables before installing crimps or other connection methods. Follow all steps of the installation instructions. Unless otherwise directed, shims must generally be installed before other components. They are then aligned at the end of the shimmed cable insulation. Where two shims are used, the inner shim should be a minimum of 15 mm longer than the outer shim.
3. Fiberglass bolt pads (EPPA-109N) are required for all bolted connections, including screws and nuts. Some kits are supplied with uncoated tubing-type bolt pads. Always follow the instructions provided with the kit.
Note: Some WCSF dimensions have a limited use range when used over a bolted connection.
4. Do not bend the splice while it is warm or hot. Heat-shrinkable tubing is mechanically weak when warmed during the heating process and can be punctured by the connection hardware if bent when warm.
5. When they are cool, do not bend TE's Raychem nuclear products to a radius smaller than 5 times the outside diameter (OD) of the installed product.
IMPORTANT: Do not violate the cable manufacturer's bend radius criteria.
6. In general, when shrinking tubing, start at any called out dimension and shrink to the opposite end (such as shims). For long splice tubing, start from the center and work first to one end and then to the other.
7. Shrink tubing by heating on all sides, including the side opposite of the installer. It is a common problem to underheat tubing, especially the side away from the installer; therefore, the installer should pay special attention to apply sufficient heat to the back side of the tubing.
8. Industrial hot-air guns are the best choice for general use with nuclear products and most of them are suitable sources of heat for installing heat shrink tubing. For further details please contact your local sales representative.

Inspection guidelines

1. Tubing is fully recovered when it conforms to the substrate and has no flat sides or wrinkles. Tubing should be evenly heated and should have equal wall thickness all the way around the splice. If you can feel flat sides or wrinkles with your fingers (wait until the temperature has dropped to a comfortable range), then it was underheated. Underheated tubing can be corrected by re-heating all the way around.
2. The tubing may appear glossy when recovered but this is not an absolute criteria of proper installation. The sealant may be visible flowing from the end of the tubing and should be visible in the larger tubing sizes (larger than WCSF-200-18/5-x/N), but it is not always visible in the smaller sizes. The tubing is installed correctly if it conforms to the substrate and has no flat spots or wrinkles.
3. Overheating is evidenced by severe scorching or blistering. If the damage cannot be removed by cleaning with solvent, the product must be replaced.

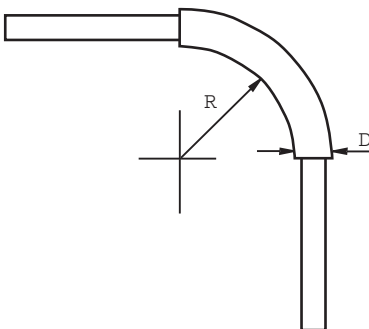

Nuclear braided sleeving

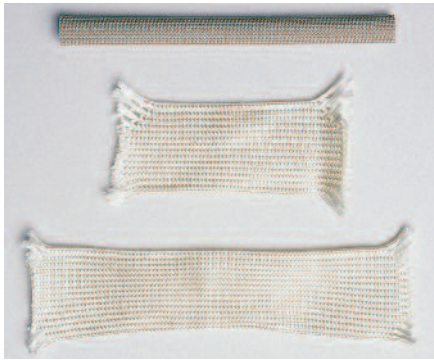

Selection guide

1. Braided sleeving is a fibreglass sleeve that is used in TE's splice kits to protect the outer WCSF-/N tubing from sharp edges and to keep the connection area free of sealant.
2. Braided sleeving has been tested for Class 1E service subject to accident conditions, such as a LOCA or HELB, when used with WCSF-/N tubing.
3. Braided sleeving is not intended to provide electrical insulation but rather should be used together with WCSF-/N in order to seal and insulate the connection.

Qualification test reports:
Wyle 58722-2, EDR-5336

Ordering description	As supplied diameter nom.	Use range	
		min.	D max.
EPPA-109N-1	13	13	23
EPPA-109N-2	23	23	43
EPPA-109N-3	36	36	71
EPPA-109N-4	58	58	102

Notes:

- Dimensions in millimetres
- Wall thickness 0.8 mm nominal all sizes
- D = Expanded diameter by compressing the length
- Continuous filament glass yarns
- Coated to reduce end fray
- Colour: tan

Roll spring for solderless earth connections



Constant force roll springs used for solderless shield and armour connections.

Ordering description	Application diameter (mm)		Width (mm)
	min.	max.	
EPPA-N-034-A	12	20	13
EPPA-N-034-B	17	28	13
EPPA-N-034-C	25	40	13
EPPA-N-034-D	36	60	13
EPPA-N-034-E	17	29	25
EPPA-N-034-F	30	39	25
EPPA-N-034-G	40	60	25
EPPA-N-034-H	50	75	30

End-cap Kits, End-caps and Breakouts

End-cap kits

- NECK - Nuclear end-cap kit 35
- Nuclear end-caps 35

Cable breakouts

- Nuclear cable breakouts 36



NECK - Nuclear end-cap kits LOCA type-tested qualified Class 1E (K1)

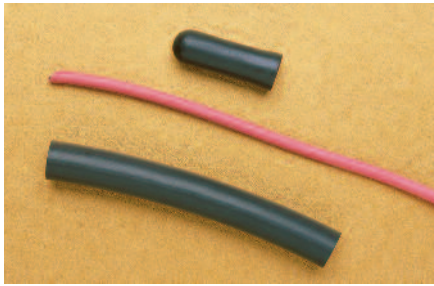

NECK (nuclear end-cap kit) is a combination of an end cap and a support tubing that is used to seal spare or unused conductors. NECK kits have been type-tested for Class 1E service inside containment to LOCA conditions. NECK kit components are made from a cross linked flame retardant polyolefin material that is very similar to the compound used in the WCSF tubing, but it is modified to allow the parts to be moulded into shape.

Qualification test reports:
EDR-5331
EDR-5332
EDR-5336
EDR-5348
EDR-5389



NECK installed

Kit description	Use range (mm)	Length (mm)
NECK-01-N	1.3 - 2.5	145
NECK-02-N	1.8 - 4.0	145
NECK-03-N	2.9 - 4.1	75
NECK-04-N	2.9 - 6.4	145
NECK-05-N	5.1 - 9.1	75
NECK-06-N	7.9 - 12.7	75
NECK-07-N	7.9 - 18.8	145
NECK-08-N	14.0 - 22.9	150
NECK-09-N	19.6 - 36.1	150
NECK-10-N	20.4 - 41.0	200

Nuclear grade end-caps

TE can provide end-caps for sealing cables that are not exposed to LOCA conditions. These end-caps are suitable for Class 1E cables in non-accident environments. The designation of these caps includes the -52/144 description, which stands for the nuclear grade moulding compound (52) and the adhesive coating (144).

Qualification test reports:
EDR-5332, EDR-5389

The application use range is for applications not subject to high temperature accident conditions such as LOCA or HELB.

Description	Diameter use range (mm)
101A011-52/144-N	2.0 - 4.1
101A021-52/144-N	3.4 - 6.6
101A031-52/144-N	4.8 - 9.1
101A041-52/144-N	6.9 - 12.7
101A052-52/144-N	10.2 - 18.8
101A062-52/144-N	12.4 - 22.9
101A073-52/144-N	19.6 - 36.1
101A083-52/144-N	24.9 - 45.7
101A094-52/144-N	41.7 - 76.2

Nuclear cable breakouts



Nuclear cable breakouts
 TE can provide cablebreakouts to seal cables that are notexposed to LOCA conditions. Thesebreakouts are suitable for Class 1E cable in non-accident environments. The designation of these breakouts includes the -52/144 descriptionwhich stands for the nuclear grademoulding compound (52) and theadhesive coating (144).

Qualification test reports:
 EDR-5332
 EDR-5336

A variety of nuclear cable breakout kits type-tested for Class 1E cables inside containment to LOCA conditions are available. Please contact your local sales representative for assistance.

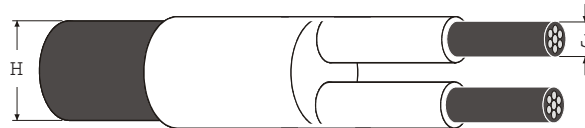

Description	Number of legs	Cable jacket "H" (body) diameter use range (mm)	Individual wire "J" (leg) diameter use range (mm)
302A720-52/144-N	2	47 - 86	21 - 38
302A812-52/144-N	2	11 - 20	2.5 - 6.9
302A823-52/144-N	2	16 - 29	4.6 - 12
302A834-52/144-N	2	25 - 47	7.6 - 19
302A845-52/144-N	2	41 - 74	14 - 34
602A212-52-02/144-N	2	11 - 22	1.5 - 3.0
403A134-52/144-N	3	24 - 44	6.9 - 17
403A145-52/144-N	3	38 - 64	13 - 27.4
403A211-52/144-N	3	9 - 18	2.5 - 6.9
403A222-52/144-N	3	16 - 30	4.3 - 11
403A232-52/144-N	3	25 - 47	9.9 - 18.8
403A242-52/144-N	3	31 - 60	14 - 27.4
602A212-52-03/144-N	3	11 - 22	1.5 - 3
502A812-52/144-N	4	13 - 23	2.5 - 5.6
502A823-52/144-N	4	19 - 35	4.6 - 10
502A834-52/144-N	4	29 - 53	7.6 - 14
502A845-52/144-N	4	46 - 85	13 - 25
602A212-52-04/144-N	4	11 - 22	1.5 - 3.0
602A114-52/144-N	5	25 - 41	4.0 - 7.6
602A212-52/144-N	5	11 - 22	1.5 - 3.0
602A312-52/144-N	5	14 - 27	2.5 - 5.6
703A155-52/144-N	6	39 - 71	7.9 - 16
803A115-52/144-N	7	39 - 71	7.9 - 16
902A014-52/144-N	8	30 - 43	4.8 - 10

Low Voltage Splice Kits

Standardized cable accessories 38

Instrumentation cable splice kit

- In-line splice kit
- Transition splice kit

Control cable splice kit

- In-line splice kit
- Transition splice kit

Power cable splice kit

- Power cable in-line splice kit
- Power cable transition splice kit

Stub splice kit

- Small conductor “V” stub splice kit

Motor connection kit

- Single feeder
- In-Line

SMOE's 40

- Selection of SMOE kits

Terminal block replacement kits 43

- NTBR

Survey of standardised cable accessories

The most common kit configurations are shown in the following pages. Many hundreds of different kits are available, most of which were developed over the past 20 or more years to serve the needs of our North American customers. These kits are tailored to their highly standardized cable constructions.

The kits are designed to connect, insulate, and environmentally seal similar or different cable types.

The insulated conductors are connected with a compression connector or a bolted lug connection (not supplied with the kit) and then insulated with WCSF-/N tubing. The jacket of the cable is then reconstructed with WCSF-/N tubing and cable breakouts or end caps, where necessary.

The general design criteria of these kits have been type-tested to LOCA environments and comply with all applicable requirements of IEEE 323 and IEEE 383.

To take into consideration the wide range of different cable constructions used worldwide in the international nuclear power generating industry, trained factory engineers and Raychem engineers have designed an additional range of nuclear kit configurations, so called SMOE kits (Special Manufacturing Order Energy).

For customized applications or configurations contact your local Tyco Electronics sales representative for assistance.

- Instrumentation cable splice kits - NPKS kits

- In-line instrumentation cable splice kit:
This kit is designed to insulate and environmentally seal instrumentation cables splices, i.e. shielded twisted pairs.



- Instrumentation cable transition splice kit:
The kit is used to transition between a multi-conductor cable and individual conductors.

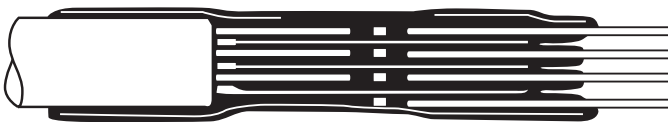

- Control cable splice kits - NPKC kits

- In-line control cable splice kits
- Control cable transition splice kit

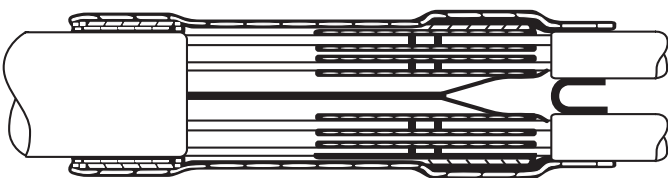

- Power cable splice kits - NPKP kits

- In-line power cable splice kit
- Power cable transition splice kit

- Stub splice kits - NPKV kits

- Small conductor "V" stub splice kit:
Kits are designed to insulate and environmentally seal small diameter wires in small enclosures typically found in valves, limit switches, small motors, and other areas where the connection space is limited. The insulated conductors are typically connected with a ring lug terminal and screws and nuts (compression connectors can also be used) then insulated and sealed with a combination of nuclear grade breakouts, tubing, and moulded end caps.

- Motor connection kits - NMCK kits

Kits are designed to insulate and environmentally seal Class 1E cable connections at 600 V motors. Each kit contains components to insulate three phases for a typical bolted lug connection inside the motor connection box.

- Single feeder



Stub configuration, 2 wires per phase

Motor connection kits are also available for parallel feeders to a single motor lead. These kits are similar in construction to the above series but have a three-finger breakout to accommodate the parallel feeder and single motor lead.



Stub configuration, 3 wires per phase

- In-line single feeder to motor lead:

Motor connection kits are also available for in-line connections to a single or parallel feeder to a motor lead.

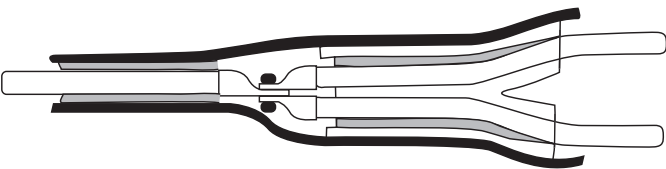

Selection of customized designed kits (SMOE kits)

- Nuclear in-line splices

- Connection with compression connector



- Bolted lug connection

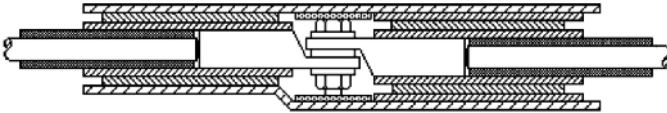

- Screwed clamp connection
single core cable to various partners

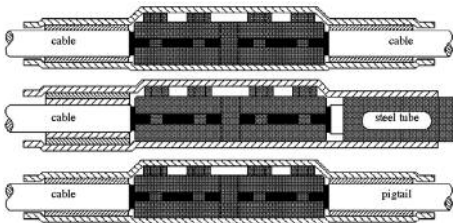

- Nuclear connector sealing kit for INOX-MI-cable connectors

- round connector (female -male)

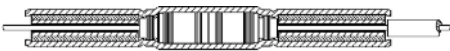

- rectangular connector (female -male)

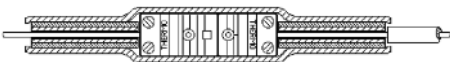

- Nuclear termination kit

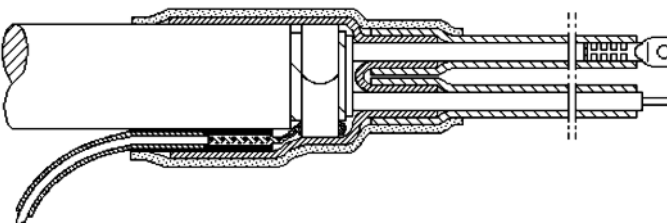

- Nuclear transition splices

- Transition with mechanical connector - large cross section single core to two pigtails

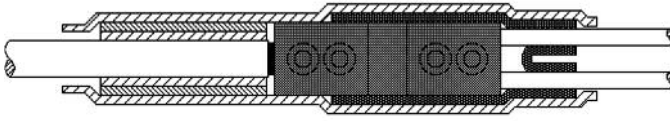

- One single-core cable to two pigtails - with parallel compression connector

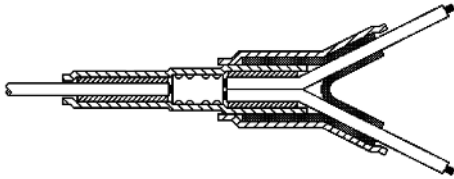

- Cable to thermo-coax assembly

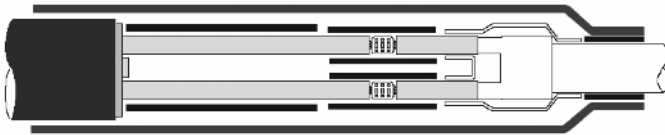

- 3-multiconductor cable to penetration pigtails

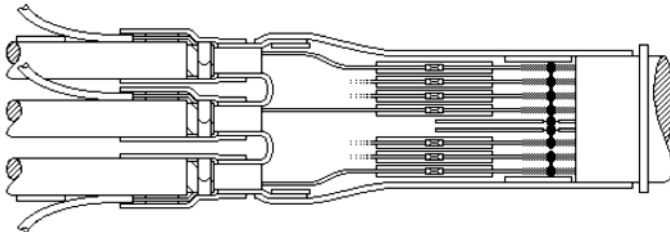

For customized applications or configurations contact your local TE sales representative for assistance.

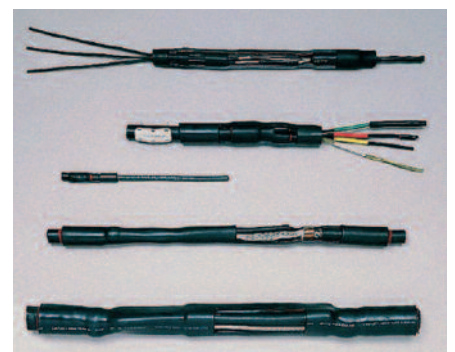

NTBR - Class 1E (K1) nuclear qualified LOCA type terminal block replacement kits

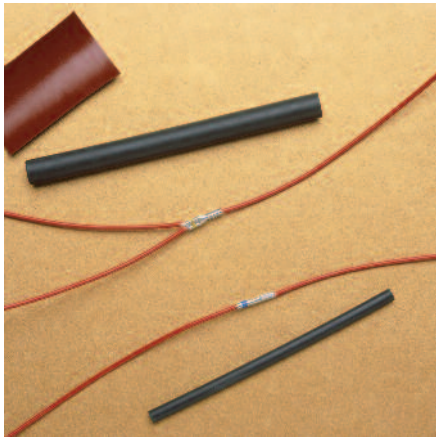

NTBR kits are designed to insulate and environmentally seal Class 1E wires that are relatively small (1.3 to 7.3 mm using WCSF-050-3/1 up to WCSF-115-9/3). These kits have been type-tested to LOCA environments and comply with all applicable requirements of IEEE 323 and IEEE 383.

These configurations use WCSF-050-3/1 as a sealed environmentally qualified electrical connection. Combinations of single wires to single wires, single wires to two wires, or two wires crimped to two wires were tested using a mastic block of S1119 adhesive instead of the normal two-leg breakout on the two-wire side for sealing. All of these configurations passed direct exposure to LOCA conditions; however, it is recommended that these splices be installed in an enclosure.

The NTBR kit is designed to replace small terminal blocks in penetrations or other terminal block cabinets.

Qualification test reports:
EDR-5331
EDR-5336
EDR-5348

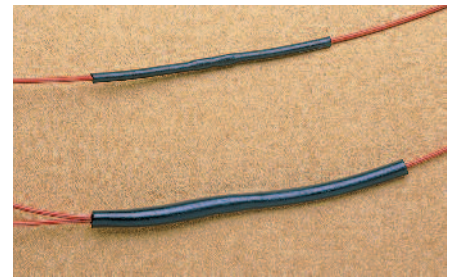

NTBR installed

1E LOCA terminal block replacement kit

New kit description	Single wire OD range (mm)	2 wire OD range (mm)	Connector dimensions OD x l (mm) max.	Splices per kit
NTBR-A-1-1-EAP	1.3 - 1.8	N/A	1.8 x 25	10
NTBR-A-1-2-EAP	1.8 - 4.4	1.1 - 2.1	4.4 x 25	10
NTBR-A-2-2-EAP	N/A	1.1 - 2.1	4.4 x 25	6
NTBR-B-1-1-EAP	1.8 - 4.4	N/A	4.4 x 25	6
NTBR-B-1-2-EAP	2.9 - 7.3	1.8 - 3.4	7.3 x 25	6
NTBR-B-2-2-EAP	N/A	1.8 - 3.4	7.3 x 25	6

Jacket Repair and Insulating Tapes

Nuclear grade heat-shrinkable tape

- NJRT 45

Small-wire nuclear grade heat-shrinkable tape

- NWRT 46

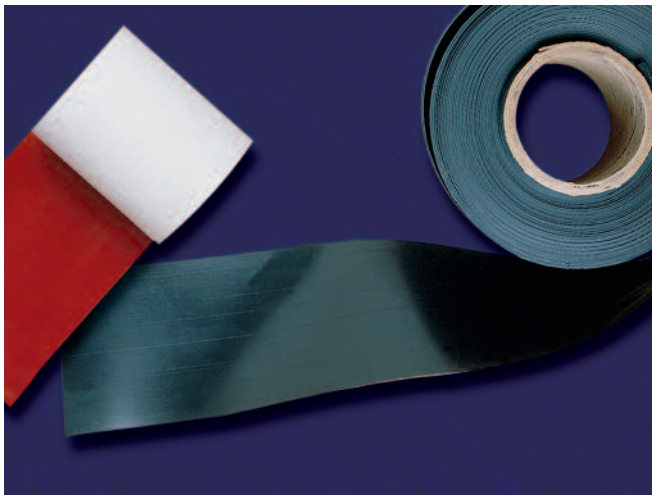

NJRT - Nuclear grade heat-shrinkable tape
Class 1E (K1) nuclear qualified LOCA type-tested heat-shrinkable tape



NJRT can be used as a moisture sealant and to repair damaged wires or cables with diameters greater than 10 mm. It can also be used over crimped connections of the same use range.

For wires or cables smaller than 10 mm, NWRT tape is recommended.



NJRT installed

NJRT is a flame retardant, cross linked polyolefin heat-shrinkable tape that is designed for electrical connections on Class 1E (K1) circuits in LOCA environments.

NJRT is a kit composed of WBTF flame retardant and heat-shrinkable insulation tape and the S1119 sealant (the same used in WCSF, but in a rolled form). The sealant is wrapped around the cable insulation and bare conductor or crimped connection area (bolted connections should not be used with NJRT). The WBTF tape is wrapped and shrunk down to complete the sealed connection.

NJRT is ideal for use on cable sections that have a damaged jacket or damaged insulation and where it is impossible to use heat-shrink tubing such as WCSF.

NJRT is supplied under TE's comprehensive Quality Assurance program with certified documentation to meet industry requirements for safety related electrical equipment.

Qualification test reports:

- EDR-5336
- EDR-5331
- EDR-5021

Ordering information

Kit description	Cable OD range (mm)	1 Kit contains		Tape width (mm)	Wall thickness recovered (mm)
NJRT-1N	> 10	WBTF tape	8 rolls, each 7.6 m	25.0	0.76
		S1119 sealant	16 rolls, each 1.5 m	25.0	N/A
NJRT-2N	> 25	WBTF tape	4 rolls, each 7.6 m	52.0	0.76
		S1119 sealant	4 rolls, each 1.5 m	55.0	N/A

NWRT - Small wire nuclear grade heat-shrinkable tape
Class 1E (K1) nuclear qualified LOCA type-tested heat-shrinkable tape



NWRT can be used as a moisture sealant or for repair purposes on damaged wires or cables with diameters ranging from 1.8 to 10.2 mm. It can also be used over crimped connections of the same use range.

NJRT tape is recommended for wires or cables larger than 10.2 mm.

NWRT is a flame retardant, cross linked polyolefin heat-shrinkable tape that is designed for electrical connections on Class 1E (K1) circuits in LOCA environments.

NWRT is a kit composed of WWTF flame retardant and heat-shrinkable insulation tape and the S1119 sealant (the same used in WCSF but in a rolled form). The sealant is wrapped around the cable insulation and bare conductor or crimped connection area (bolted connections should not be used with NWRT). The WWTF tape is wrapped and shrunk down to complete the sealed connection.



NWRT installed

NWRT is ideal for use on cable sections that have a damaged jacket or damaged insulation and where it is impossible to use heat-shrink tubing such as WCSF.

NWRT is supplied under TE's comprehensive Quality Assurance program with certified documentation to meet industry requirements for safety related electrical equipment:

Flammability:
 Passed ICEA S-19-81 Sec. 6.19.6

Qualification test reports:
 EDR-5046
 EDR-5258
 EDR-5021

Ordering information

Kit description	Cable OD range (mm)	1 Kit contains	Tape width (mm)	Wall thickness recovered (mm)
NWRT-1	1.8 - 10.2	Tape WWTF Sealant S1119	2 rolls, each 3.0 m 1 roll (1.5 m)	0.5 N/A

High Voltage Products

Nuclear high voltage termination kits for single-core cables

- NHVT (SMOE) 48

Nuclear high voltage termination kits for 3-core cables

- MOD-3-NHVT (SMOE) 49

Nuclear high voltage heat-shrinkable bus bar tubing

- BBIT-N 49

Nuclear high voltage heat-shrinkable insulating tape

- HVBT-RN 50

Nuclear high voltage cable to bus connections

- HVBT-CBC-N 51



NHVT(SMOE) - Nuclear high voltage terminations for 1/C shielded cables 5 - 15 kV



Cable with copper tape shield - grounding with roll spring and solder-blocked copper ground braid

NHVT(SMOE) termination kits are designed to properly terminate and environmentally seal screened medium voltage (also referred to as high voltage) indoor power cables rated up to 15 kV. These kits are used for several shield configurations such as copper tape, copper wire shield, or other common metallic shielding systems.

The termination uses Raychem stress control tubing for electrical stress mitigation at the semi-conductive screen, nuclear-grade sealants, and the Raychem non-tracking tubing on the outer surface to provide a sealed termination.

All kits for metal-tape shielded cable include a water blocked copper braid conductor and a roll spring for grounding.

NHVT(SMOE) kits are used in medium voltage motors, at penetrations, inside switchgear, and at transformer connections (up to 15 kV).

In view of the wide range of possible cable constructions, we recommend discussing and confirming the intended application before proceeding. For further assistance, please contact your TE sales representative with all available cable data.

NHVT(SMOE) kits have been qualification type-tested for Class 1E circuits with limited harsh environmental exposure (HELB conditions as described in EDR-5037).

Note:
This product has not been type-tested to LOCA conditions.

Qualification test reports:
EDR-5018
EDR-5021
EDR-5022
EDR-5037
EDR-5060
EDR-5063
Report 71100, Rev. 1



NHVT (SMOE) after installation

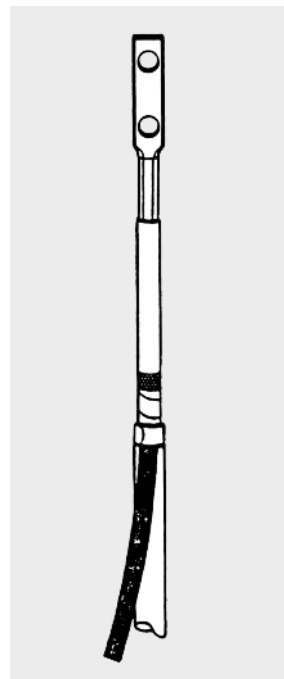

MOD-3-NHVT(SMOE) – 3/C modification kits for use with Raychem NHVT(SMOE) 1/C nuclear high voltage terminations, (5 – 15 kV)

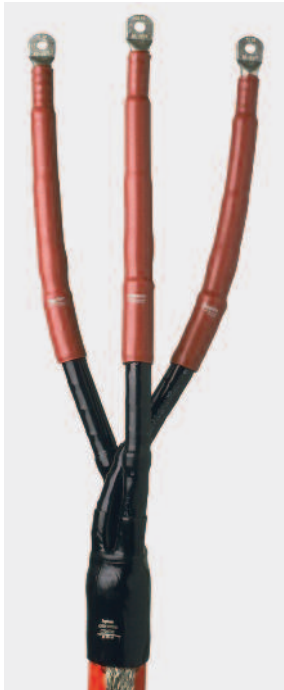

The MOD-3-NHVT(SMOE) kits are designed to trifurcate 3/C cables into three 1/C cables, by adding a sealing breakout boot to the crotch area of the 3/C cable and re-jacketing tubing on the outer surface of the three phase conductors. Once installed, the three 1/C cables are then terminated with standard 1/C NHVT(SMOE) kits.

In view of the wide range of possible cable constructions, we recommend discussing and confirming the intended application before proceeding. For further assistance, please contact your TE sales representative with all available cable data.

Note:
This product has not been type-tested to LOCA conditions.

Qualification test reports:
EDR-5336
EDR-5331
EDR-5332
EDR-5021

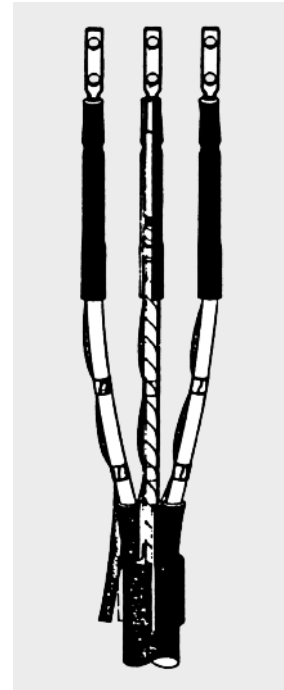

MOD-3-NHVT(SMOE)

BBIT-N – Heat-shrinkable insulating tubing for bus bars 5 – 15 kV



BBIT-N is a medium voltage heat-shrinkable tubing that is used to insulate straight or slightly bent bus bars.

BBIT-N is used to insulate an exposed bus bar in order to prevent accidental flashover or minimize the clearance distance between two phases or phase and ground.

BBIT-N is rated to the switchgear specification ANSI/IEEE C37.20-1987. BBIT-N has been shown to tolerate irradiation to 500 kGy (50 Mrad) and has been tested to an accelerated aged condition of 40 years at 90°C.

Note:
This product has not been type-tested to LOCA conditions.

Qualification test reports:
EDR-5037
EDR-5063

Description	Diameter use range (mm)	Standard package (meters per reel/box)
BBIT-N-25/10-A/U	10.4 – 19.8	25
BBIT-N-40/16-A/U	16.8 – 32.0	20
BBIT-N-65/25-A/U	26.2 – 49.8	15
BBIT-N-100/40-A/U	41.9 – 79.8	15

HVBT-RN - Heat-shrinkable insulating tape for bus bars 5 - 15 kV

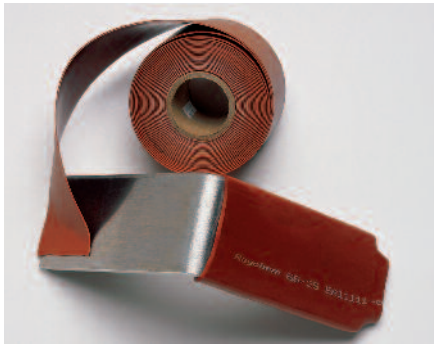

HVBT-RN is a medium voltage heat-shrinkable tape that is used to insulate straight or bent bus bars. This versatile tape can be used to cover irregular geometries that are not well suited for tubing.

HVBT-RN can also be used as insulation for cable-to-bus connections in switchgear or transformers where a cable and bolt used to connect the lug to the bus create an irregular geometry. These connections are first wrapped with copper mesh (to smooth out the geometry) before being insulated with HVBT-RN.



HVBT-RN installed

Refer to the following page for HVBT-CBC-N kits for this application.

HVBT-RN has been shown to tolerate irradiation up to 500 kGy (50 Mrad) and has been tested to an accelerated aged condition of 40 years at 90 °C.

Note:
This product has not been type-tested to LOCA conditions. Commercial dedication is required for use on Class 1E systems.

Qualification test reports:
UVR-8023
EDR-5154
EDR-5259

Description	Width (mm)	Length per roll (m)
HVBT-1-RN	25	7.6
HVBT-2-RN	50	7.6
HVBT-4-RN	100	7.6

HVBT-CBC-N - Cable to bus connections 5 - 15 kV to switchgear or transformer



HVBT-RN - with copper mesh

HVBT-CBC-N is a medium voltage kit that is used as insulation for cable-to-bus connections in switchgear or transformers where a cable and bolt used to connect the lug to the bus create an irregular geometry. These connections are first wrapped with copper mesh to smooth out the geometry and then insulated with HVBT-RN.



HVBT-CBC-N installed

The heat-shrinkable tape in the HVBT-CBC-N kit is HVBT-RN.

HVBT-RN has been shown to tolerate irradiation up to 500 kGy (50 Mrad) and has been tested to an accelerated aged condition of 40 years at 90 °C.

Qualification test reports:

- UVR-8023
- EDR-5154
- EDR-5259

Note:

This product has not been type-tested to LOCA conditions. Commercial dedication is required for use on Class 1E systems.

Ordering information:

Order quantity: multiples of 3 kits

Kit description	1 kit contains	Tape width (mm)
HVBT-CBC-N	HVBT-2-RN, tape 1 roll (7.6 m) EPPA-009, copper mesh 1 roll (3.0 m)	50.0 64.0

Commercial Products and Tools

Portable hot air heater

- CV-1981 MK2 / CV-1983 53

PR reflectors

- PR 12 - PR 51 54

Barrel adaptor

- AD-1962 54

Tool sets

- IT 1000-xxx 55

CV-1981 MK2 / CV-1983 portable hot air heater



CV-1981

Heavy duty bench or hand held hot air tool for installation of various heat shrink products.

The CV-1981-MK2 and the CV-1983 thermoguns are robust, double insulated, heavy duty hot air tools.



CV-1983

A motor-driven fan forces air through the heating element, which is enclosed in a stainless steel barrel and safety guard. The thermoguns are fitted with a triac power control that regulates power to the element by means of a control knob located at the rear of the gun. This is how the user controls the output temperature. Output wattage is therefore variable. An integral stand allows the CV-1981-MK2, and the CV-1983 to be used as a bench mounted tool.

The thermogun is available in a variety of models, and is suited to a wide range of heat shrink applications. The various push-on reflectors of the PR series can be easily and quickly attached to the gun, allowing use with a wide range of heat shrink products. The CV-1983 has a larger wattage element, and so a larger barrel. Due to its larger diameter, it generates a higher volume of air flow. However, it achieves the same temperatures as the CV-1981-MK2. The CV-1983 is best suited for use with larger tubing and moulded parts.

Note:

The optional barrel adaptor AD-1962 is required to use the PR range of reflectors with the CV-1983.

Technical specifications:

Electrical supply	CV-1981-MK2 CV-1983	120 V or 240 V 120 V or 240 V
Power consumption	CV-1981-MK2 CV-1983	1600 W 2260 W/3060 W
Total system noise	CV-1981-MK2 CV-1983	65 dB 65 dB
Length	CV-1981-MK2 CV-1983	340 mm 320 mm
Weight	CV-1981-MK2 CV-1983	1.3 kg 1.5 kg
Air flow	CV-1981-MK2 CV-1983	max. 230 l/min max. 500 l/min

Ordering information:

Equipment	Description
CV-1981-MK2	CV-1981-120 V-1600 W - UK - MK2 CV-1981-120 V-1600 W - CAN- MK2 CV-1981-230 V-1600 W - MK2 CV-1981-230 V-1600 W - UK - MK2 CV-1981-230 V-1600 W - SEV - MK2
CV-1983	CV-1983-110 V-2260 W - UK CV-1983-220 V-2260 W CV-1983-220 V-2260 W - UK CV-1983-220 V-3060 W CV-1983-220 V-3060 W - UK
CV-1983 barrel adaptor	AD-1962

PR reflectors

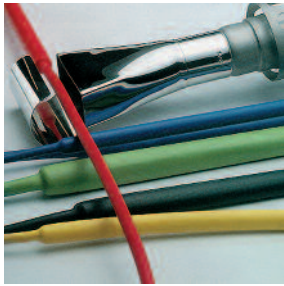

Lightweight, stainless steel heat reflectors ensure fast, even recovery of Raychem heat-shrinkable products.

The Raychem PR series is a range of lightweight hot air reflectors specially designed to optimise the efficiency of Raychem heating devices when used to apply heat shrinkable tubing and moulded parts.

Fabricated from polished stainless steel, these reflectors are designed to fit the Raychem CV-1981 series of hot air guns. Each reflector creates the ideal individual environment to ensure fast, even recovery of a wide range of heat-shrinkable products.



Ordering information:

Product range	Description
Tubing from 6 mm to 25 mm diameter	PR-12
Tubing up to 6 mm diameter	PR-13
Large SolderSleeve terminations	PR-13C
Long lengths of tubing up to 25 mm diameter	PR-21
Small moulded parts and tubing from 25 mm to 35 mm diameter	PR-24
Moulded parts and tubing from 35 mm to 60 mm diameter	PR-24A
SolderSleeve terminations up to 7 mm diameter	PR-25
Large SolderSleeve terminations from 7 mm to 13 mm	PR-25D
Miniature SolderSleeve terminations and small products	PR-26
SolderSleeve terminations from 20 mm to 27 mm diameter	PR-33
SolderSleeve terminations from 12 mm to 20 mm diameter	PR-34
Special narrow reflector for moulded part transitions (21.5 x 3.5 mm nozzle)	PR-51
Barrel adaptor to use PR-reflectors with portable hot air heater CV-1983	AD-1962

Tool sets



Complete tool kit IT 1000-001-CEE01



Complete tool kit IT 1000-001-CEE02

These tool kits contain all of the basic tools usually required for the cable preparation and the installation of accessories. Different tool sets are assembled in a leather case.

The tool kit IT-1000-001-CEE01 includes the following tool sets assembled in a leather case:

Item number	Description of contents
IT-1000-005	1 x Hammer, 300 g 1 x Screwdriver, 3.5 mm 1 x Screwdriver, 6.5 mm 1 x Hacksaw 1 x Hacksaw junior
IT-1000-006	1 x Pipe wrench, 250 mm 1 x Side cutter, 160 mm 1 x Pincers, 180 mm 1 x Blunt nose pliers, 180 mm 1 x Scissors, 200 mm
IT-1000-007	1 x Folding ruler, 2 m 1 x Wire brush 1 x Hook knife 1 x Cable knife 1 x Sharpening stone, 125 x 100 mm 1 x File set, medium size
IT-1000-008	1 x Control mirror, 100 x 100 mm 1 x Spreader, 3-way 2 x Core separator 6 x Cleaning tissues 1 x Refillable solvent bottle (empty), 0.4 litres
IT-1000-010	1 x Diameter tape, 2 m
IT-1000-011	1 x Scoring tool for easy-strip screens
IT-1000-012	1 x Leather tool case, 400 x 125 x 280 mm

The tool kit IT-1000-001-CEE02 includes (in addition to tool kit IT-1000-001-CEE01) the following tool sets:

Item number	Description of contents
IT-1000-003	1 x Wedge positioner for spreading cable cores
IT-1000-015	1 x Tee-handles spinner wrench, 300 mm 1 x hexagon insert socket for wrenches, 13 mm 1 x hexagon insert socket for wrenches, 17 mm 1 x hexagon insert socket for wrenches, 19 mm 1 x hexagon insert socket for wrenches, 22 mm

The individual tool sets can also be ordered separately.

TE Energy is a worldwide leader with innovative solutions from the power plant to the end user.



Cable accessories

- Low voltage accessories
- Medium voltage joints
- Medium voltage terminations
- Medium voltage switchgear connection systems
- High voltage accessories
- Nuclear qualified products

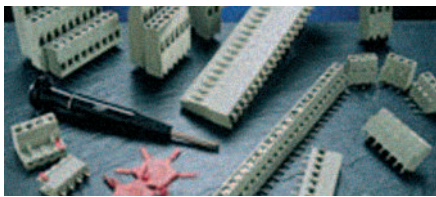

Connectors and fittings

- Nuclear qualified terminal blocks
- Interconnection products for control wiring
- Solderless terminals and splices
- Bolted connectors and clamps
- Insulation piercing connectors
- Copper compression connectors and lugs
- Bimetallic connectors and lugs
- Mechanical connectors and lugs
- Wedge pressure technology connectors
- Heliformed, cast, and compression fittings
- Transmission line spacers and dampers
- Application tooling

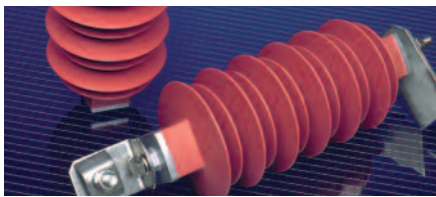

Surge arresters

- Low voltage surge arresters
- Medium voltage surge arresters
- High voltage surge arresters

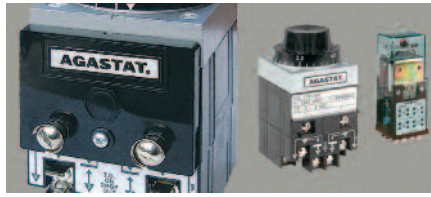

Switching, protection, and lighting

- Nuclear qualified timers and relays
- Energy saving products
- Photo controls
- Photo control accessories, receptacles shorting caps
- H.P.S. starter
- Test equipment
- MCB distribution board systems
- Moulded-case circuit breakers
- Fuse combination units
- Panel board systems
- Transient voltage surge suppression (TVSS) for mains power, data/network, telecommunication
- Flexible insulated bars



Insulators, and insulation

- Insulators
- Insulation enhancement



Identification

- Nuclear qualified heat-shrink cable markers
- ID products for wire, cable, and harness
- Stainless steel markers and cable ties
- Printing systems
- Software
- Pre-print services
- Laser etching of stainless steel labels

About TE Connectivity

TE Connectivity is a global, \$14 billion company that designs and manufactures approximately 500,000 products that connect and protect the flow of power and data inside the products that touch every aspect of our lives. Our nearly 100,000 employees partner with customers in virtually every industry – from consumer electronics, energy and healthcare, to automotive, aerospace and communication networks – enabling smarter, faster, better technologies to connect products to possibilities.

More information on TE Connectivity can be found at: www.te.com

While TE Connectivity (TE) has made every reasonable effort to ensure the accuracy of the information in this catalog, TE does not guarantee that it is error-free, nor does TE make any other representation, warranty or guarantee that the information is accurate, correct, reliable or current. TE reserves the right to make any adjustments to the information contained herein at any time without notice. TE expressly disclaims all implied warranties regarding the information contained herein, including, but not limited to, any implied warranties of merchantability or fitness for a particular purpose. The dimensions in this catalog are for reference purposes only and are subject to change without notice. Specifications are subject to change without notice. Consult TE for the latest dimensions and design specifications. Raychem, TE Connectivity and TE Connectivity (logo) are trademarks. Other logos, product and company names mentioned herein may be trademarks of their respective owners.

TE Energy – innovative and economical solutions for the electrical power industry: cable accessories, connectors & fittings, insulators & insulation, surge arresters, switching equipment, street lighting, power measurement and control.

Tyco Electronics Raychem GmbH
a TE Connectivity Ltd. Company
TE Energy
Finsinger Feld 1
85521 Ottobrunn/Munich, Germany

Phone: +49-89-6089-0
Fax: +49-89-6096345

energy.te.com

