

REV
C **AEC16-40S ***

REVISIONS			
SYM	DESCRIPTION	DATE	APPROVED
NC	NEW RELEASE PER E.O. P17539	11-20-01	R.D.R.
A	REVISED PER E.O. P17720	4-12-02	R.D.R.
B	REVISED PER E.O. P20131	7-29-10	R.D.R.
C	REVISED PER ECO-13-005317	11-8-12	D.M.

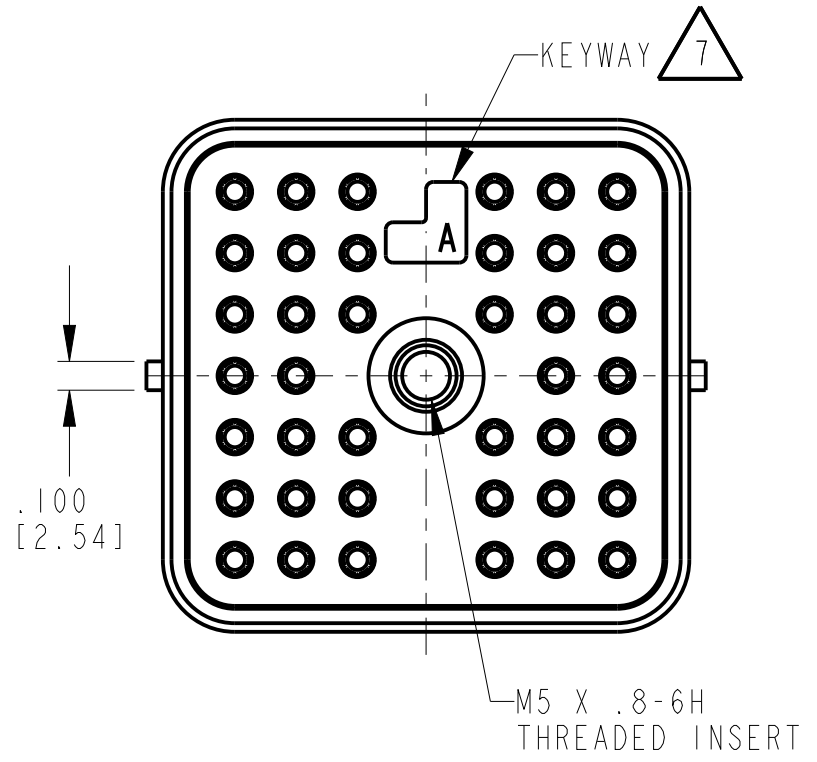
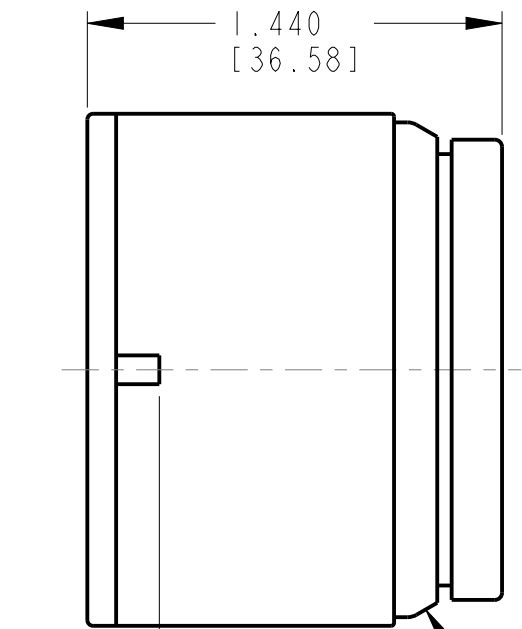
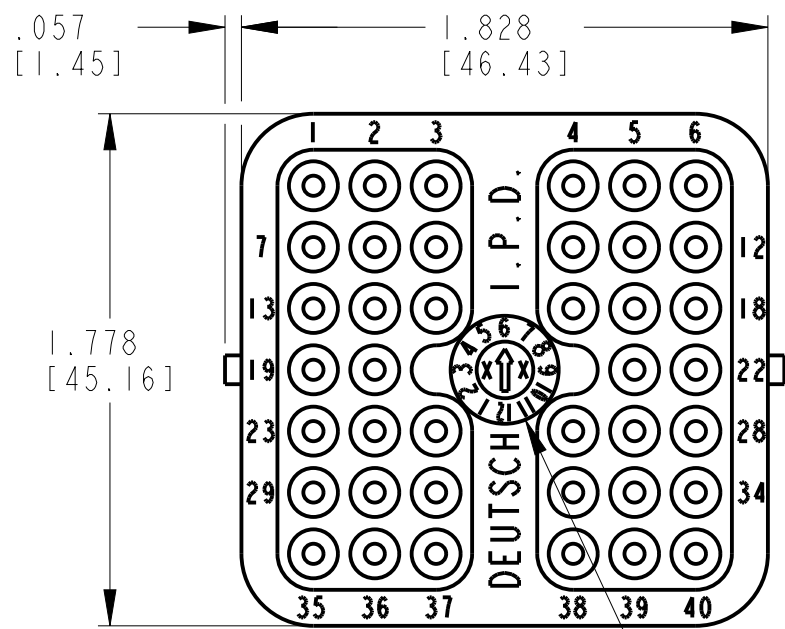

7 SEE SHEET 2 FOR OTHER KEY ARRANGEMENTS.

6. MATERIAL- PLUG: PLASTIC; SEAL/GROMMET: RUBBER; THREADED INSERT: STEEL.

5. THIS PLUG MATES WITH AEC14-40P*-**** AND AEC17-40P*-**** RECEPTACLE. (*=A,B,C,D KEYS; ****=ALL MODIFICATIONS). CONSULT FACTORY FOR MODS.

4 FOR CONTACTS AND WIRE PERFORMANCE AND APPLICATION CHARACTERISTICS, SEE ENVELOPE DRAWING 0425-015-0000.

3. PLUG SUPPLIED WITH DUST CAP. (NOT SHOWN).

2. DIMENSION TOLERANCE: ±.025 [.635].

1. DIMENSIONS ARE IN INCHES [mm].

NOTES:

MIN. INSUL. OD [mm]	MAX. INSUL. OD [mm]	WIRE RANGE [mm ²] REF ONLY
.100 [2.540]	.134 [3.404]	14-20 AWG [2.0-0.50]

SIGNATURE & DATE	
DR	J. APOSTOL 05NOV2012
CHK	D. HASIBUAN 11/7/12
PE	D. HASIBUAN 11/7/12
APPD	D. MEYER 11/8/12
SCALE NONE	WT —

PLUG
40 SIZE 16
KEYS: A,B,C,D
AEC SERIES

ENVELOPE

EP	MATL. CODE
 3850 INDUSTRIAL AVE. HEMET, CA 92545	
B	AEC16-40S *
DWG SIZE	CODE 11139 SHEET 1 OF 2

REV
C

AEC16-40S*

REVISIONS			
SYM	DESCRIPTION	DATE	APPROVED
C	SEE SHEET 1	11-8-12	D.M.

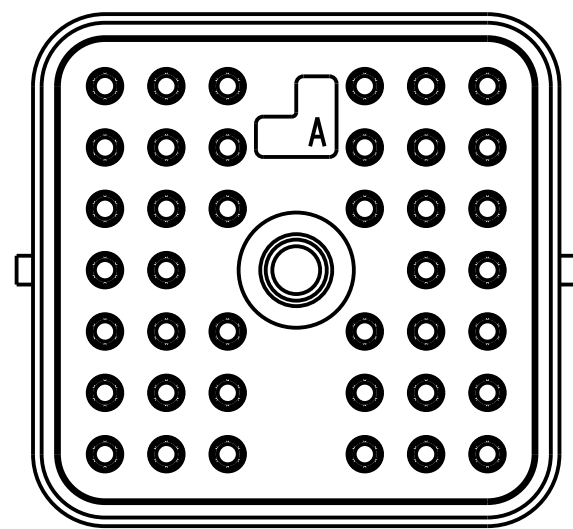

AEC16-40SA
KEY 'A'

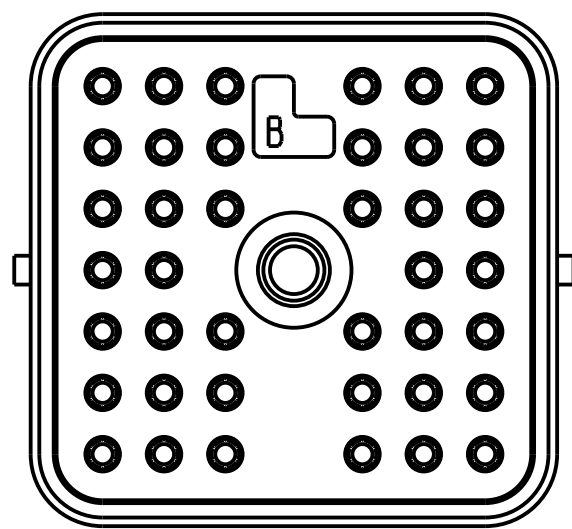

AEC16-40SB
KEY 'B'

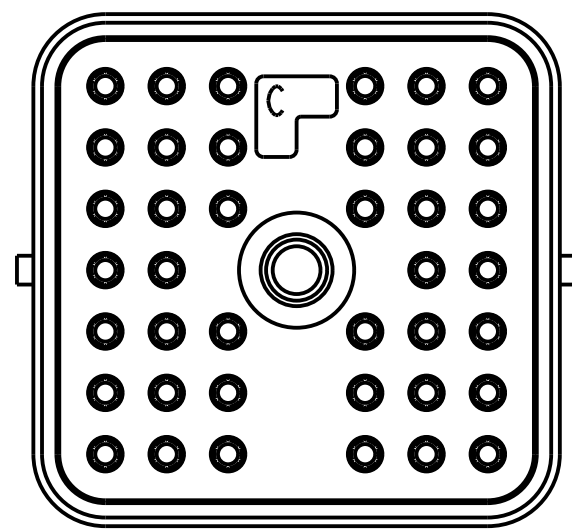

AEC16-40SC
KEY 'C'

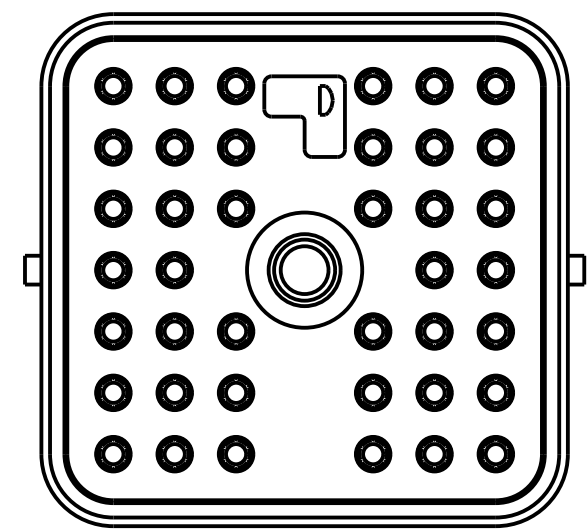

AEC16-40SD
KEY 'D'

NOTES:

SIGNATURE & DATE	
DR	J. APOSTOL 05NOV2012
CHK	D. HASIBUAN 11/7/12
PE	D. HASIBUAN 11/7/12
APPD	D. MEYER 11/8/12
SCALE	NONE
WT	—

PLUG
40 SIZE 16
KEYS: A,B,C,D
AEC SERIES

ENVELOPE

EP	MATL. CODE
 3850 INDUSTRIAL AVE. HEMET, CA 92545	
B	AEC16-40S*
DWG SIZE	CODE 11139 SHEET 2 OF 2

