

LOC	DIST	REVISIONS			
P	LTR	DESCRIPTION	DATE	DWN	APVD
	B	REVISED PER ECO-15-007451	30JUN2015	JA	DM
	C	REVISED PER PCN E-18-010846	25JUL2018	SM	DM
	C1	REVISED PER PCN-22-149104	10AUG2022	JT	IG

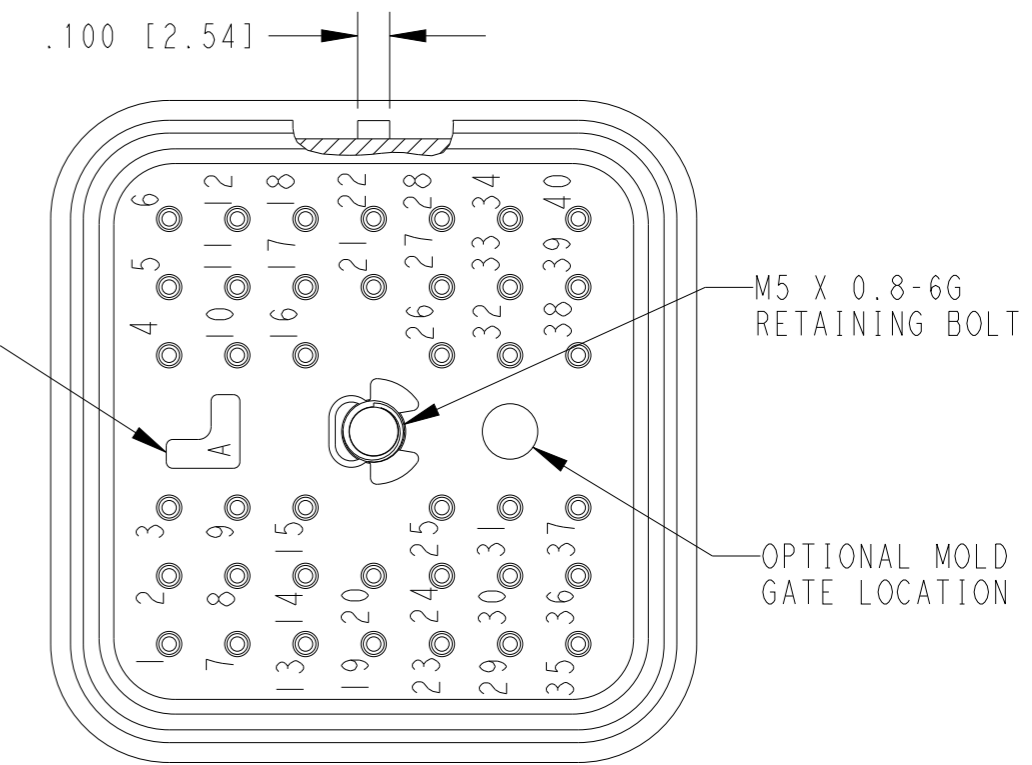
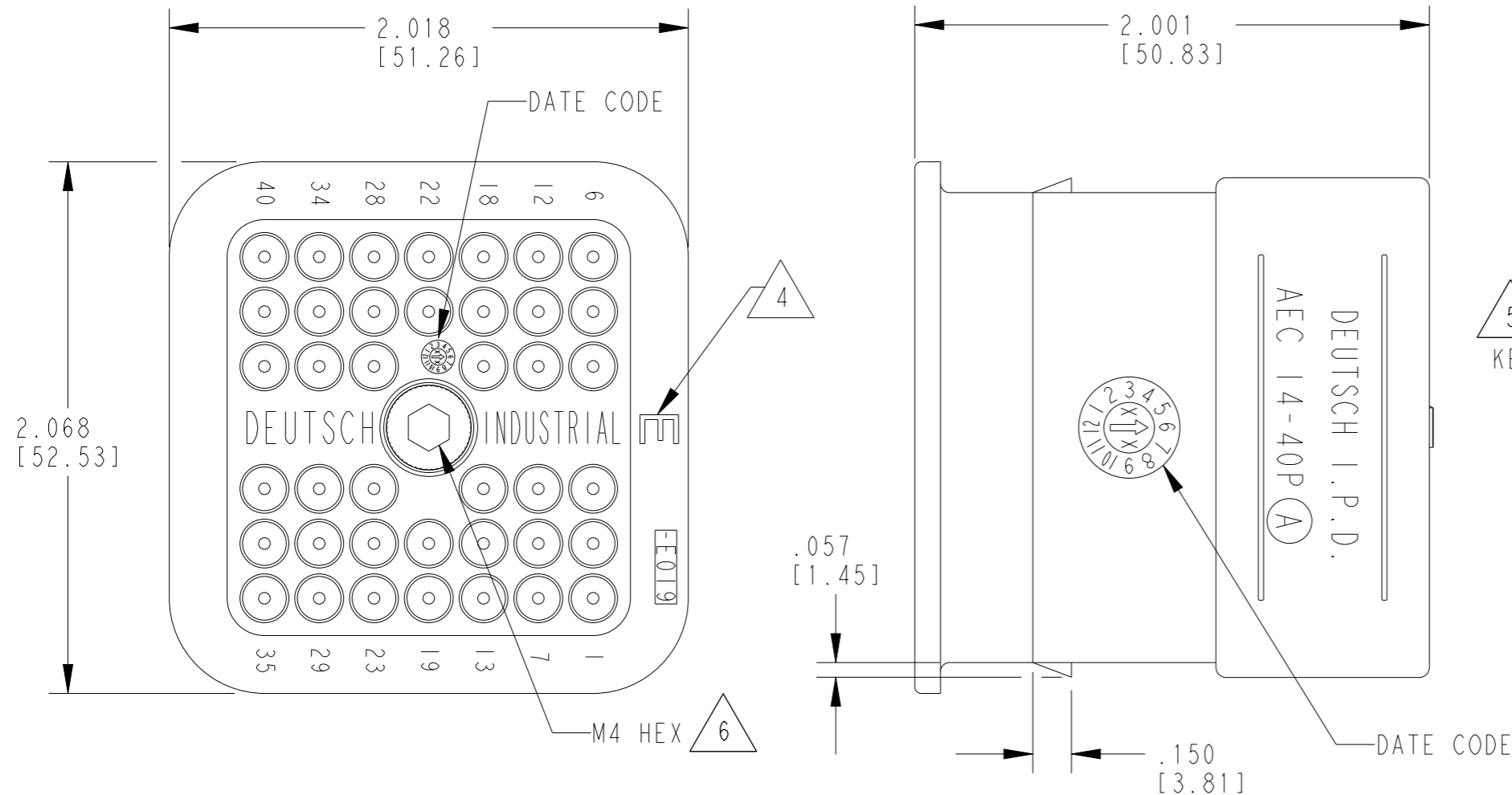

MIN. INSUL. OD [mm]	MAX. INSUL. OD [mm]	WIRE RANGE [mm ²] REF ONLY
.053 [1.346]	.120 [3.048]	14-20 AWG [2.0-0.50]

- 6 MATING TORQUE REQUIREMENT: 25-28 IN-LB [2.82-3.16 Nm].
- 5 SEE SHEET 2 FOR OTHER KEY ARRANGEMENTS.
- 4 'E' SEAL IDENTIFIED BY LETTER "E" MARK.
- 3 MATERIAL: RECEPTACLE: PEI GF 30% (BLACK)
 SEAL/GROMMET: VMQ (RED-ORANGE)
 BOLT: STAINLESS STEEL WITH SILVER PLATED AND MAY TARNISH.
 CLIP: STEEL, UNPLATED.

2. THIS RECEPTACLE MATES WITH AEC16-40SX-XXXX; AEC18-40SX-XXXX AND AEC16-40SU PLUGS. (X=A,B,C,D,U KEYS; XXXX=ALL MODIFICATIONS). CONSULT FACTORY FOR MODS.

1. RECEPTACLE IS SUPPLIED WITH DUST CAP. (0515-009-4005).

NOTES: UNLESS OTHERWISE SPECIFIED

TE INTERNAL PN	DEUTSCH PN	THEORETICAL WEIGHT
AEC14-40PAE-E019	AEC14-40PAE-E019	103.89g
AEC14-40PBE-E019	AEC14-40PBE-E019	
AEC14-40PCE-E019	AEC14-40PCE-E019	
AEC14-40PDE-E019	AEC14-40PDE-E019	
AEC14-40PABE-E019	AEC14-40PABE-E019	103.77g
AEC14-40PCDE-E019	AEC14-40PCDE-E019	

THIS DRAWING IS A CONTROLLED DOCUMENT.

DWN 04FEB2008 JAIME C. APOSTOL
 CHK 14AUG2008 BRICE BYFORD
 APVD 11AUG2008 DAVID MEYER

PRODUCT SPEC 0425-015-0000
 APPLICATION SPEC

WEIGHT SEE TABLE A3
 Customer Drawing

STE TE Connectivity

NAME RECEPTACLE, 40 SIZE 16 KEYS A,B,C,D,AB,CD E-SEAL -E019 MOD, AEC SERIES

SIZE A3 CAGE CODE 4AFU8 DRAWING NO. AEC14-40PXXE-E019 RESTRICTED TO -

SCALE 5:3 SHEET 1 OF 2 REV C1

DIMENSIONS: INCHES [mm]	TOLERANCES UNLESS OTHERWISE SPECIFIED:
0 PLC	±
1 PLC	±
2 PLC	±
3 PLC	±.025 [0.64]
4 PLC	±
ANGLES	±
FINISH	±

LOC	DIST	REVISIONS					
		P	LTR	DESCRIPTION	DATE	DWN	APVD
		-		SEE SHEET 1	-	-	-

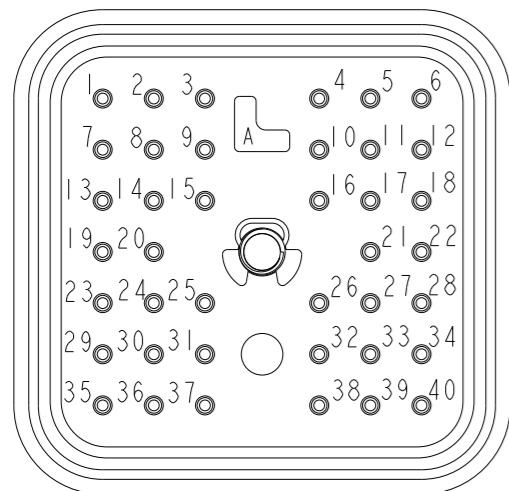

AEC14-40PAE-E019
KEY 'A'

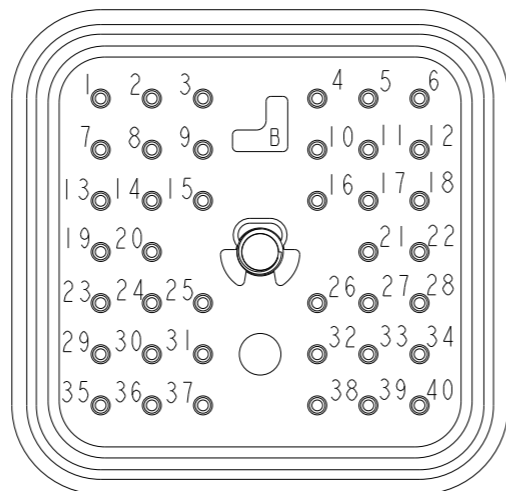

AEC14-40PBE-E019
KEY 'B'

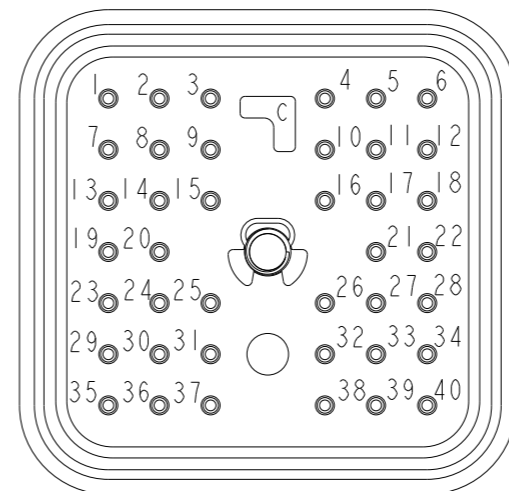

AEC14-40PCE-E019
KEY 'C'

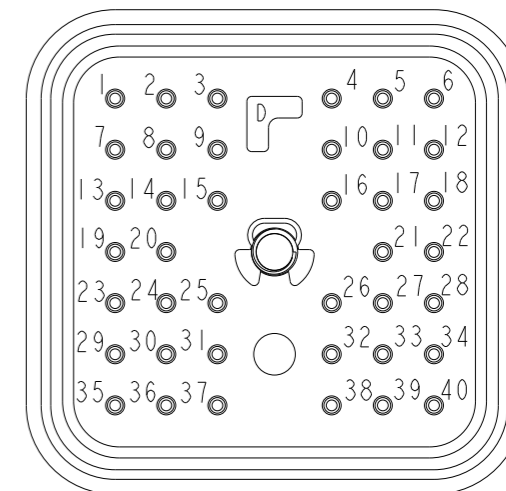

AEC14-40PDE-E019
KEY 'D'

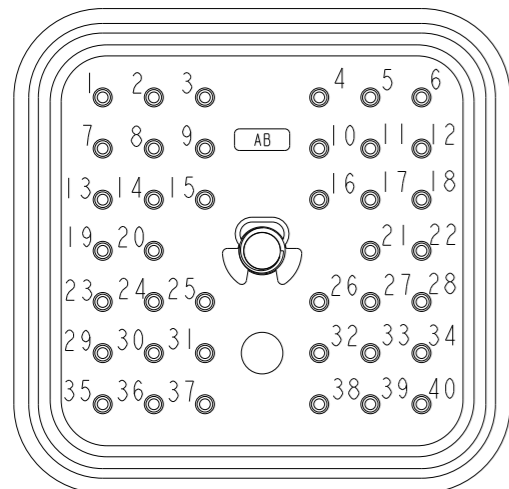

AEC14-40PABE-E019
KEY 'AB'

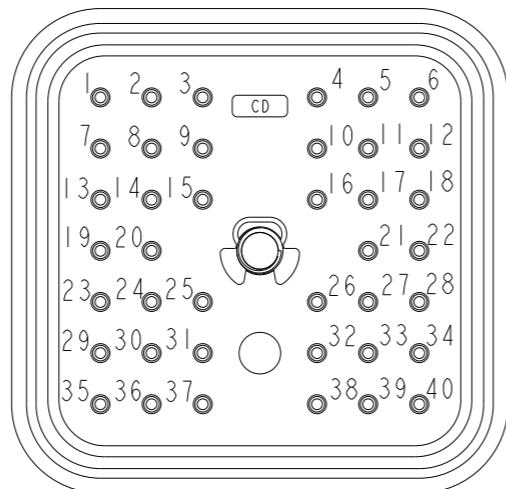

AEC14-40PCDE-E019
KEY 'CD'

THIS DRAWING IS A CONTROLLED DOCUMENT.		DWN JAIME C. APOSTOL 04FEB2008																
DIMENSIONS: INCHES [mm]		CHK BRICE BYFORD 14AUG2008																
TOLERANCES UNLESS OTHERWISE SPECIFIED:		APVD DAVID MEYER 11AUG2008	NAME RECEPTACLE, 40 SIZE 16 KEYS A,B,C,D,AB,CD E-SEAL -E019 MOD, AEC SERIES															
<table border="0"> <tr><td>0 PLC</td><td>±</td></tr> <tr><td>1 PLC</td><td>±</td></tr> <tr><td>2 PLC</td><td>±</td></tr> <tr><td>3 PLC</td><td>±.025 [0.64]</td></tr> <tr><td>4 PLC</td><td>±</td></tr> <tr><td>ANGLES</td><td>±</td></tr> </table>		0 PLC	±	1 PLC	±	2 PLC	±	3 PLC	±.025 [0.64]	4 PLC	±	ANGLES	±	PRODUCT SPEC 0425-015-0000	SIZE A3	CAGE CODE 4AFU8	DRAWING NO AEC14-40PXXE-E019	RESTRICTED TO -
0 PLC	±																	
1 PLC	±																	
2 PLC	±																	
3 PLC	±.025 [0.64]																	
4 PLC	±																	
ANGLES	±																	
MATERIAL 3		APPLICATION SPEC	SCALE 5:4		SHEET 2 OF 2	REV C1												
		WEIGHT	Customer Drawing															