

NOTES :

- 1 Au-VERSION OF CONTACT IS 1-xxxxxx-1
Au-Version des Kontaktes ist 1-xxxxxx-1
- 2 WATER TIGHTNESS ACC. GMI 12590; 5.10.3
FURTHER INFORMATIONS SEE PRODUCT SPECIFICATION 108-18102-1/...-9
Wasserdichtheit nach GMI 12590; 5.10.3
Weitere Informationen siehe Produktspezifikation 108-18102-1/...-9
- 3 Einfall bis auf 23.5mm zulässig
SHRINKAGE UP TO 23.5MM ALLOWED

| JPT | ORDER-NO. STRIP | WIRE SIZE (mm ²) | MATERIAL | FINISH | SINGLE WIRE SEAL | COLOR | WATER-TIGHTNESS |
|-----|-----------------|------------------------------|----------|--------|------------------|------------|-----------------|
| JPT | 0-0929937-1 | 1.5 - 2.5 | CuFe 2 | TINNED | 0-0828905-1 | WHITE | IPX 9K |
| JPT | 0-0929939-1 | 0.75 - 1.0 | CuFe 2 | TINNED | 0-0828904-1 | LIGHT BLUE | IPX 9K |
| JPT | 0-0929939-1 | 0.5 | CuFe 2 | TINNED | 0-0963294-1 | BLUE | IPX 9K |
| JPT | 0-0929941-1 | 0.35 | CuFe 2 | TINNED | 0-0963294-1 | BLUE | IPX 9K |

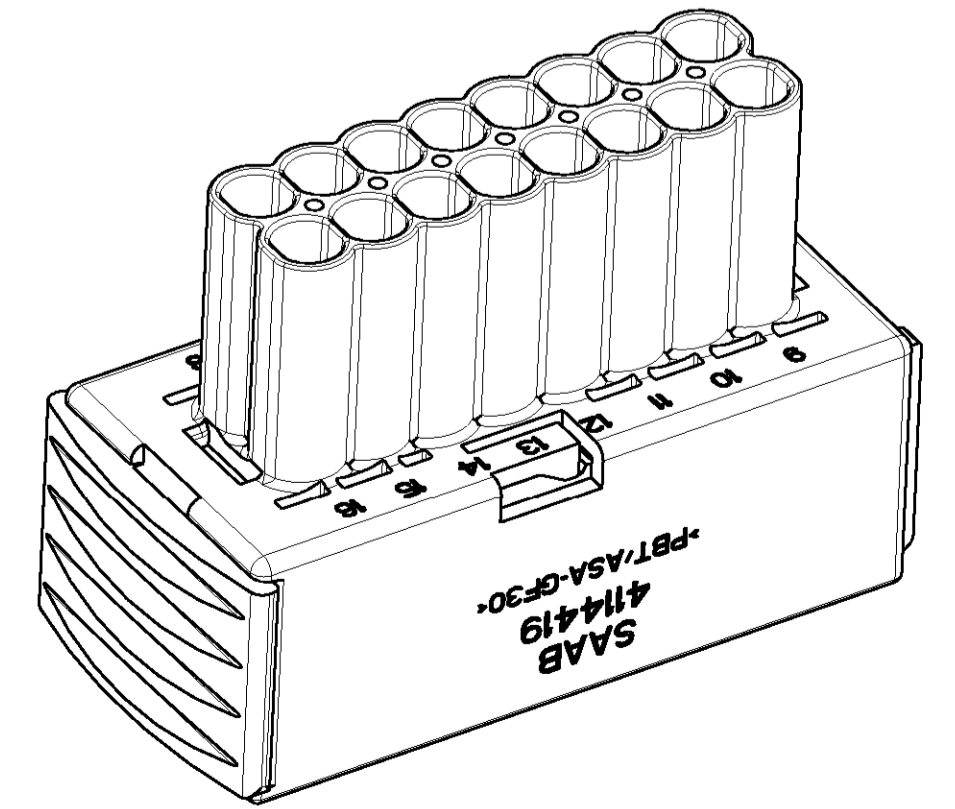

2:1

| CUSTOMER PART NO. | GM SIGN | PART NO. | REV. | PCS | MATERIAL | COLOR | DESCRIPTION | ITEM NO. |
|-------------------|----------|-------------------------|------|-----|--------------|-------|------------------|----------|
| 4114401 | | 5-963217-1 CODING N | E | 1 | PBT/ASA-GF30 | RED | SLIDE | 6 |
| 4114443 | | 4-963217-1 CODING D1 | E | 1 | PBT/ASA-GF30 | WHITE | JPT HSG., 16POS. | 5 |
| 4114435 | | 3-963217-1 CODING C1 | E | 1 | PBT/ASA-GF30 | RED | SLIDE | 6 |
| 4114427 | | 2-963217-1 CODING B1 | F | 1 | PBT/ASA-GF30 | BLUE | JPT HSG., 16POS. | 3 |
| 4114419 | ZFW 16-2 | 1-963217-1 CODING A1 | F | 1 | PBT/ASA-GF30 | RED | SLIDE | 6 |
| | | | | 1 | PBT/ASA-GF30 | BLACK | JPT HSG., 16POS. | 1 |

| LOC | DIST | REV | DATE | DRN | APVD |
|-----|------|-----|---------|-----|------|
| A1 | - | F3 | 28APR11 | RK | HMR |

PROJECT-NO.:
A89-52101

CODING A1

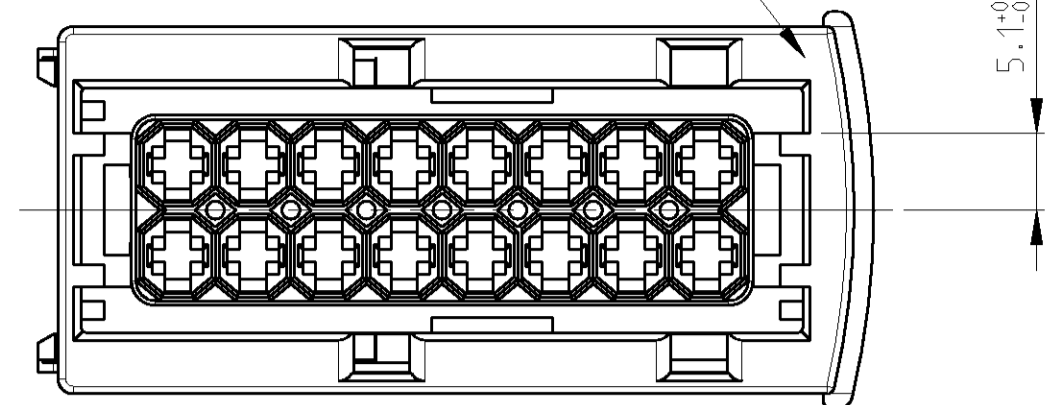

CODING B1

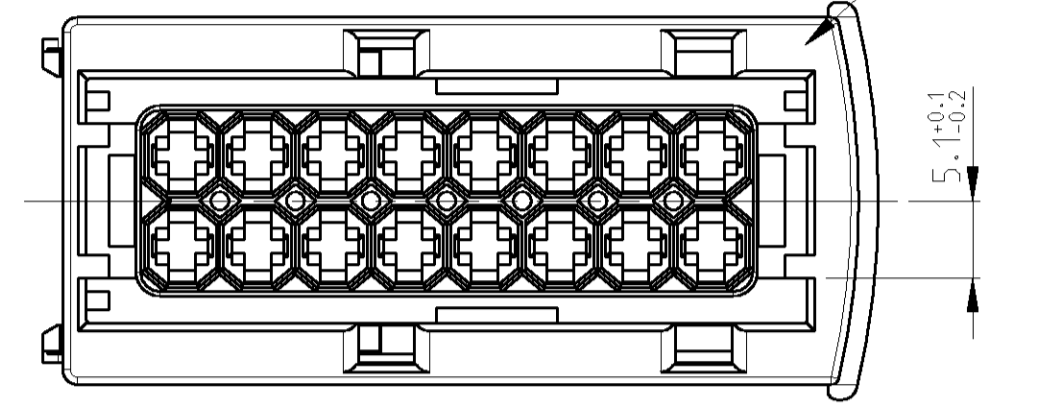

CODING C1

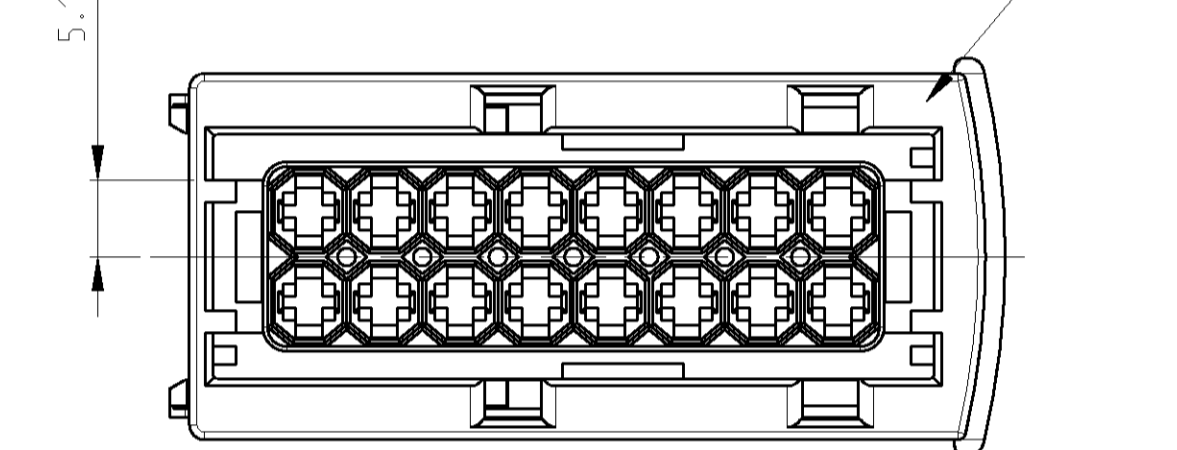

CODING D1

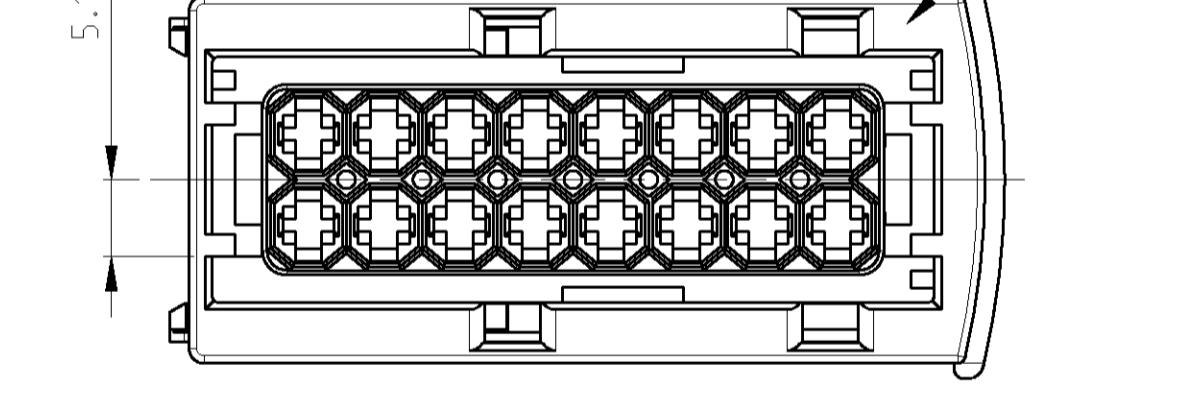

CODING N

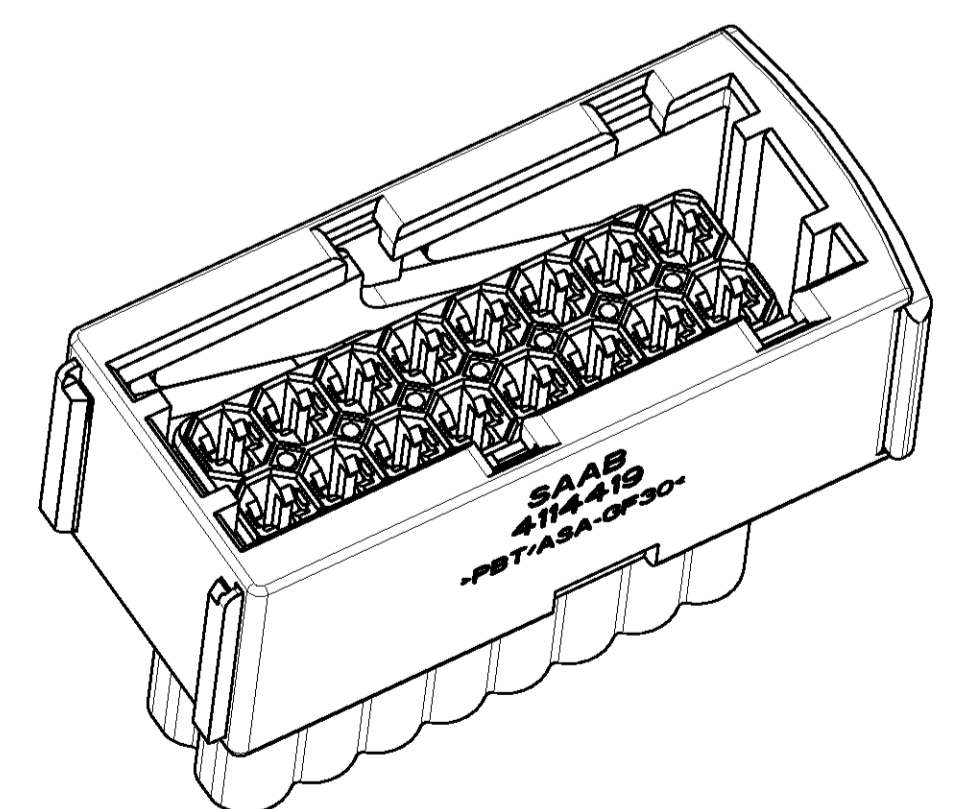
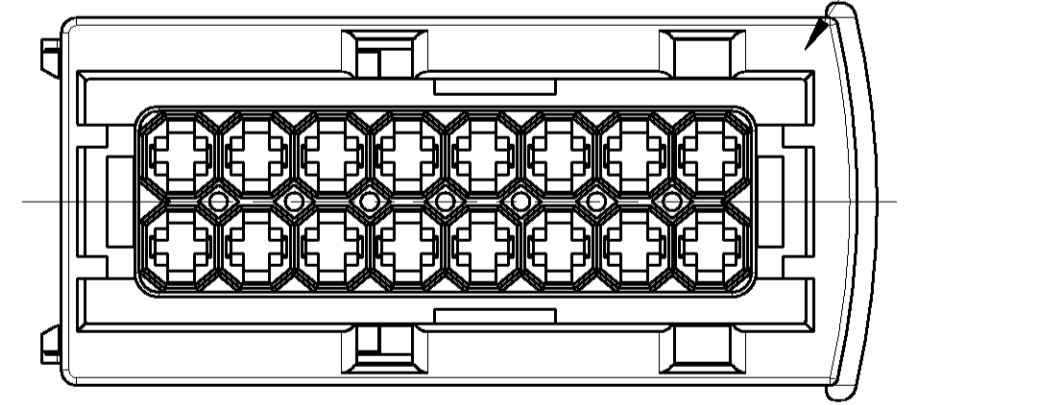

2:1

| DIMENSIONS: | | TOLERANCES UNLESS OTHERWISE SPECIFIED: | | REVISIONS | |
|-------------|--|--|---|----------------------------------|---------|
| mm | | 0 PLC | # | DATE | DRN |
| | | 1 PLC | # | 28APR11 | RK |
| | | 2 PLC | # | | |
| | | 3 PLC | # | | |
| | | 4 PLC | # | | |
| | | ANGLES | # | | |
| MATERIAL | | FINISH | | DESCRIPTION | DATE |
| | | | | JPT REC-HOUSING, 16POS., ASSY | 28APR11 |
| | | | | JPT Buchsengehäuse, 16pol., Assy | |
| | | | | SIZE | DRN |
| | | | | 108-18102 | 28APR11 |
| | | | | APPLICATION SPEC | |
| | | | | 114-18175 | |
| | | | | WEIGHT | |
| | | | | - | |
| | | | | CUSTOMER DRAWING | |
| | | | | SCALE | 2:1 |
| | | | | SHEET | 1 OF 1 |
| | | | | REV | F3 |



NAME: JPT REC-HOUSING, 16POS., ASSY
JPT Buchsengehäuse, 16pol., Assy

SIZE: 108-18102
APPLICATION SPEC: 114-18175

WEIGHT: -
CUSTOMER DRAWING: A1 00779 C-963217

SCALE: 2:1 SHEET: 1 OF 1 REV: F3