

REVISIONS				
P.	LTN	DESCRIPTION	DATE	APVD
B3		ADD NEW DASH NUMBER -16	24APR2014	CZ SZ

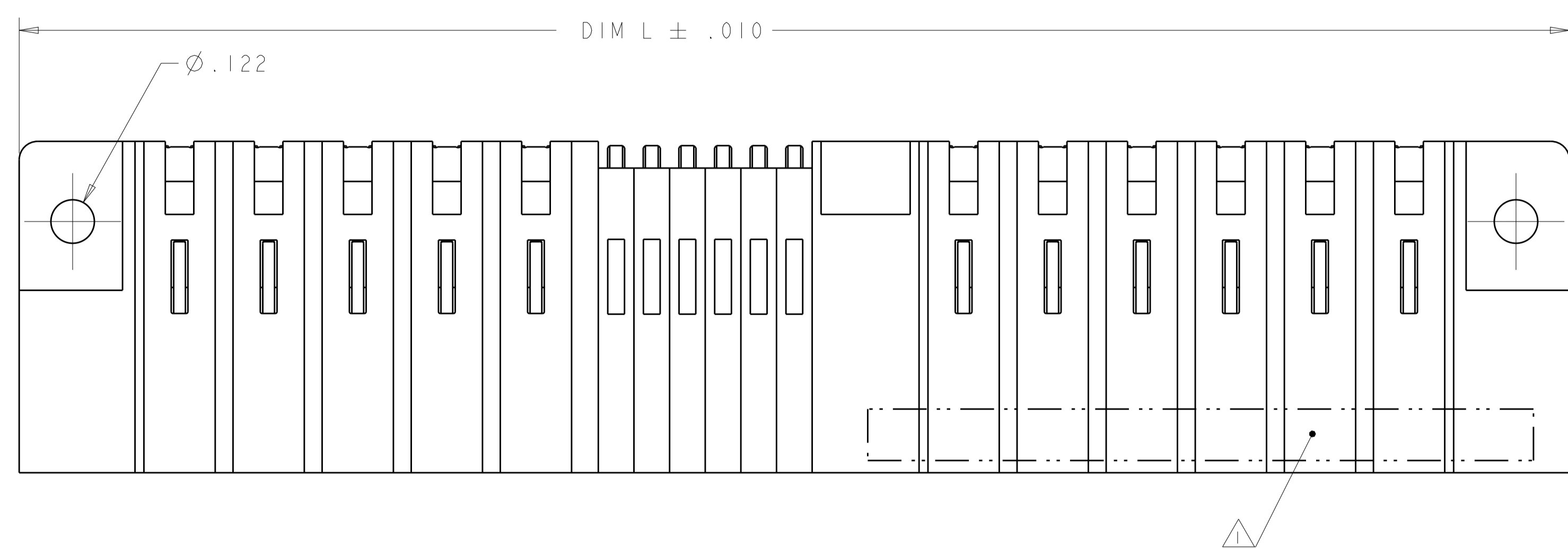

- 1 "AMP", PART NUMBER, AND DATE CODE TO BE MARKED IN AREA SHOWN
- 2 MATERIAL: HOUSING - GLASS FILLED HIGH TEMP THERMO PLASTIC, UL94 V-0  
 SIGNAL CONTACT - COPPER ALLOY  
 POWER CONTACT - HIGH CONDUCTIVITY COPPER ALLOY
- 3 CONTACT PLATING: NOBLE METAL PLATING ON CONTACT FUNCTIONAL AREA OF POWER AND SIGNAL CONTACTS
- 4 MECHANICAL CONNECTOR KEEP OUT ZONE.
- 5 DATUM AND BASIC DIMENSIONS ESTABLISHED BY CUSTOMER.
- 6 PCB - ALL HOLE DIAMETERS ARE FINISHED HOLE SIZES
- 7 PCB - .0453 ± .0010 DRILLED HOLES PLATED WITH .0003 MIN Sn OVER .001-.003 CU PLATING TO ACHIEVE .040 ± .003 DIAMETER HOLE
- 8 VARIABLE DIMS SHOWN ON VIEW (SHEET 2)
- 9 NOT RELEASED FOR PRODUCTION

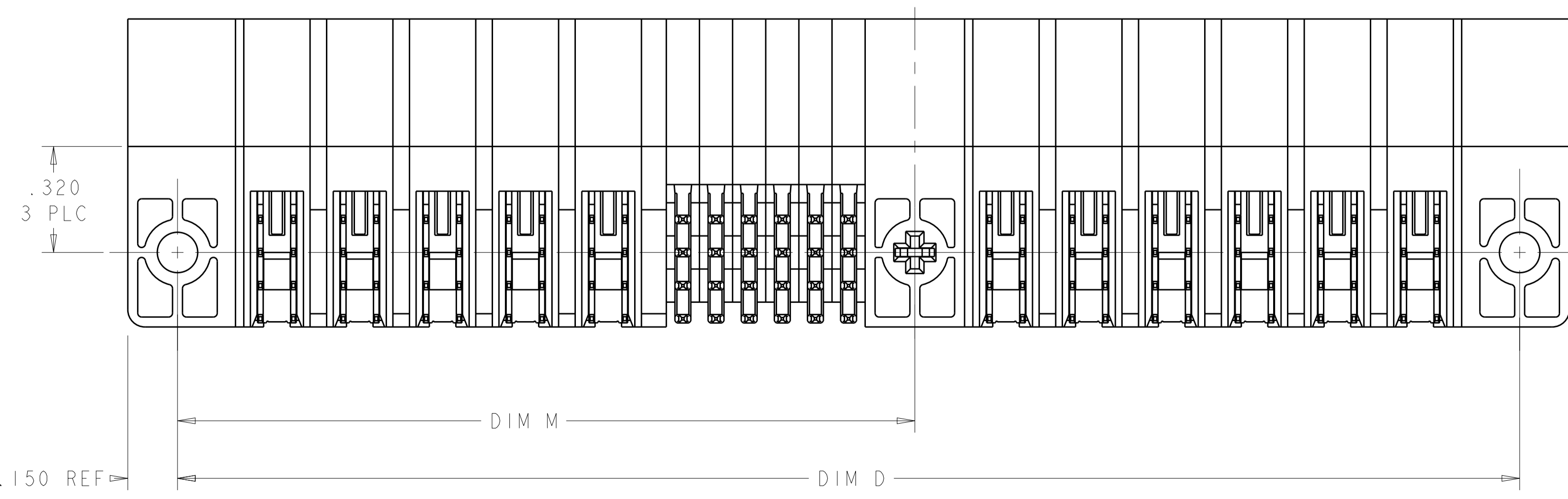
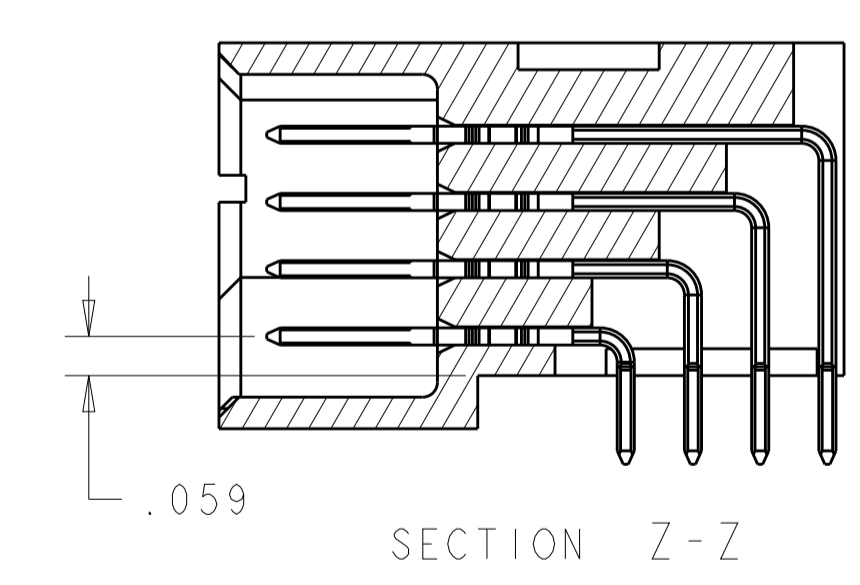
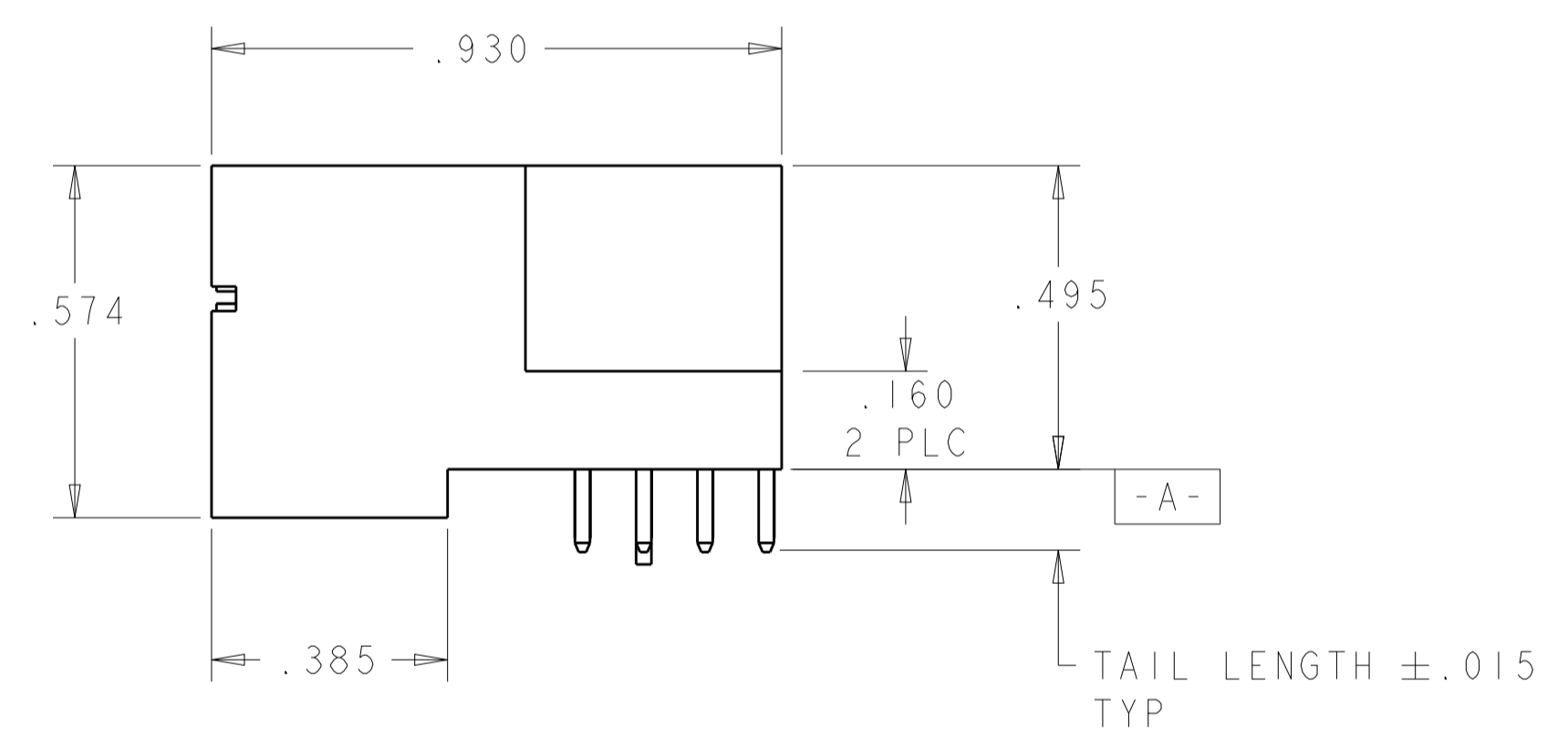
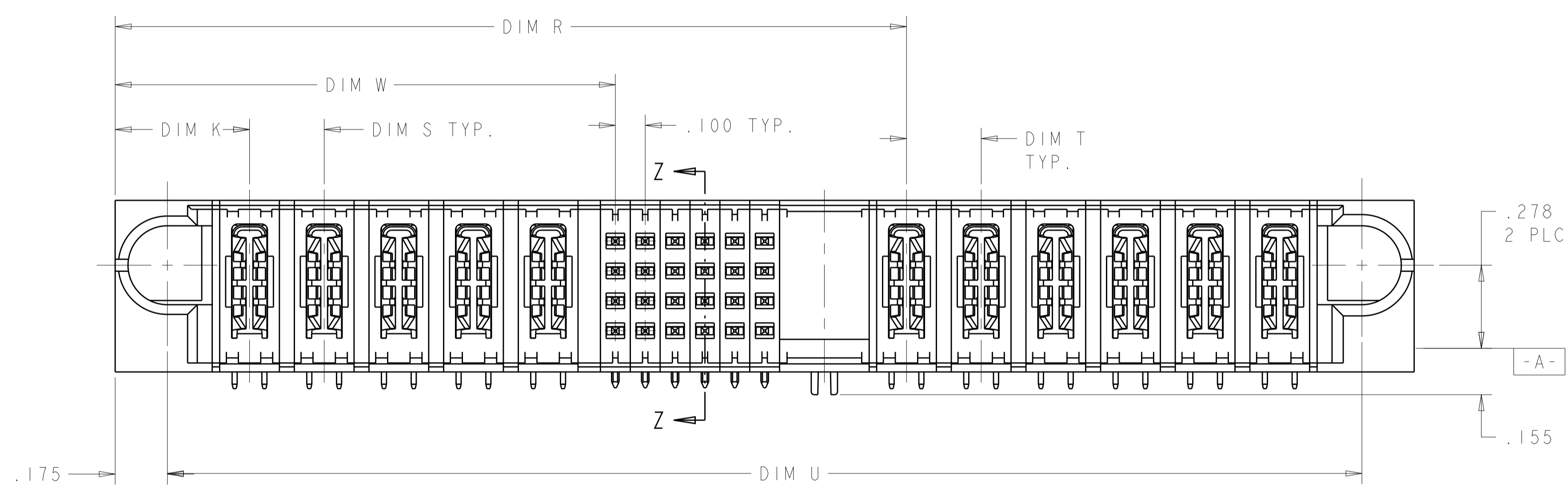

THIS DRAWING IS A CONTROLLED DOCUMENT.		DWN: R.GRZYBOWSKI 22FEB05 CHK: M.PERCHEK 22FEB05 APVD: M.PERCHEK PRODUCT SPEC: 108-1973 APPLICATION SPEC: 114-13038 WEIGHT: - CUSTOMER DRAWING	NAME: RIGHT ANGLE SOLDER HEADER ASSEMBLY MULTI-BEAM XL SIZE: A1 SCALE: 7:2 SHEET: 1 OF 6 REV: B3	TE Connectivity
DIMENSIONS: INCHES 0 PLC ± 1 PLC ±.01 2 PLC ±.005 3 PLC ±.0020 ANGLES ±.2° FINISH:	TOLERANCES UNLESS OTHERWISE SPECIFIED: ±.01 ±.005 ±.0020 ±.2°	RESTRICTED TO: - SCALE: 7:2 SHEET: 1 OF 6 REV: B3		

THIS DRAWING IS UNPUBLISHED. RELEASED FOR PUBLICATION 20  
 © COPYRIGHT 20 BY - ALL RIGHTS RESERVED.

REVISIONS				
P.	LTN	DESCRIPTION	DATE	APVD
-		SEE SHEET 1	-	-

2.750	.250	-	2.650	1.375	2.800	-	3.100	.450	4P + 48S + 1P	I-6450230-6
5.150	.300	.300	3.550	2.700	5.200	-	5.500	.450	8ACP + 32S + 6ACP	I-6450230-5
2.300	.300	.250	1.950	1.275	2.350	-	2.650	.475	3ACP + 24S + 2P	6450230-6
5.450	.250	.250	3.350	2.375	5.500	-	5.800	.450	8P + 36S + 9P	6450230-4
4.275	.250	.250	3.175	2.500	4.325	-	4.625	.475	2ACP + 6P + 24S + 5P	6450230-3
4.000	.250	.250	2.650	1.675	4.050	2.225	4.350	.450	5P + 24S + 1M + 6P	6450230-2
4.000	.250	.250	2.650	1.675	4.050	2.225	4.350	.450	5P + 24S + 1M + 6P	6450230-1
DIM U	DIM S	DIM T	DIM R	DIM W	DIM D	DIM M	DIM L	DIM K	DESCRIPTION	PART NUMBER

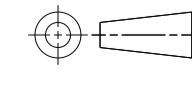
THIS DRAWING IS A CONTROLLED DOCUMENT.		DWN R. GRZYBOWSKI	22FEB05	 TE Connectivity
		CHK M. PERCHERKE	22FEB05	
DIMENSIONS: INCHES		TOLERANCES UNLESS OTHERWISE SPECIFIED:		APVD M. PERCHERKE
		0 PLC ±	PRODUCT SPEC	NAME
		1 PLC ±.01	108-1973	RIGHT ANGLE SOLDER HEADER ASSEMBLY
		3 PLC ±.005	APPLICATION SPEC	MULTI-BEAM XL
		4 PLC ±.0020	114-13038	
		ANGLES ±.0020	FINISH	SIZE
				A1
MATERIAL			WEIGHT	CAGE CODE
				-
				DRAWING NO
				6450230
				RESTRICTED TO
				-
CUSTOMER DRAWING		SCALE		SHEET
		7:2		2 OF 6
				REV
				B3

REVISIONS				
P. LTH	DESCRIPTION	DATE	OWN	APVD
-	SEE SHEET 1	-	-	-

PART NUMBER	ROWS	POWER					SIGNAL						CM	POWER					
		P1	P2	P3	P4	P5	1	2	3	4	5	6		P6	P7	P8	P9	P10	P11
6450230-1	D C B A	PM	PM	PM	PM	PM	J	J	J	J	J	J	HD	PM	PM	PM	PM	PM	PM
		PM	PM	PM	PM	PM	K	K	K	K	K	K		PM	PM	PM	PM	PM	
		PM	PM	PM	PM	PM	N	N	N	N	N	N		PM	PM	PM	PM	PM	
		PM	PM	PM	PM	PM	S	S	S	S	S	H		PM	PM	PM	PM	PM	

5P + 24S + 1M + 6P

PART NUMBER	ROWS	POWER								SIGNAL						POWER					
		P1	P2	P3	P4	P5	P6	P7	P8	1	2	3	4	5	6	P9	P10	P11	P12	P13	
6450230-3	D C B A	PM	PM	PM	PM	PM	PM	PM	PM	E	J	E	E	J	E		PM	PM	PM	PM	PM
		PM	PM	PM	PM	PM	PM	PM	K	K	F	K	K	K	PM		PM	PM	PM	PM	
		PM	PM	PM	PM	PM	PM	PM	N	N	N	G	N	N	PM		PM	PM	PM	PM	
		PM	PM	PM	PM	PM	PM	PM	H	S	H	H	S	H	PM		PM	PM	PM	PM	

2ACP + 6P + 24S + 5P

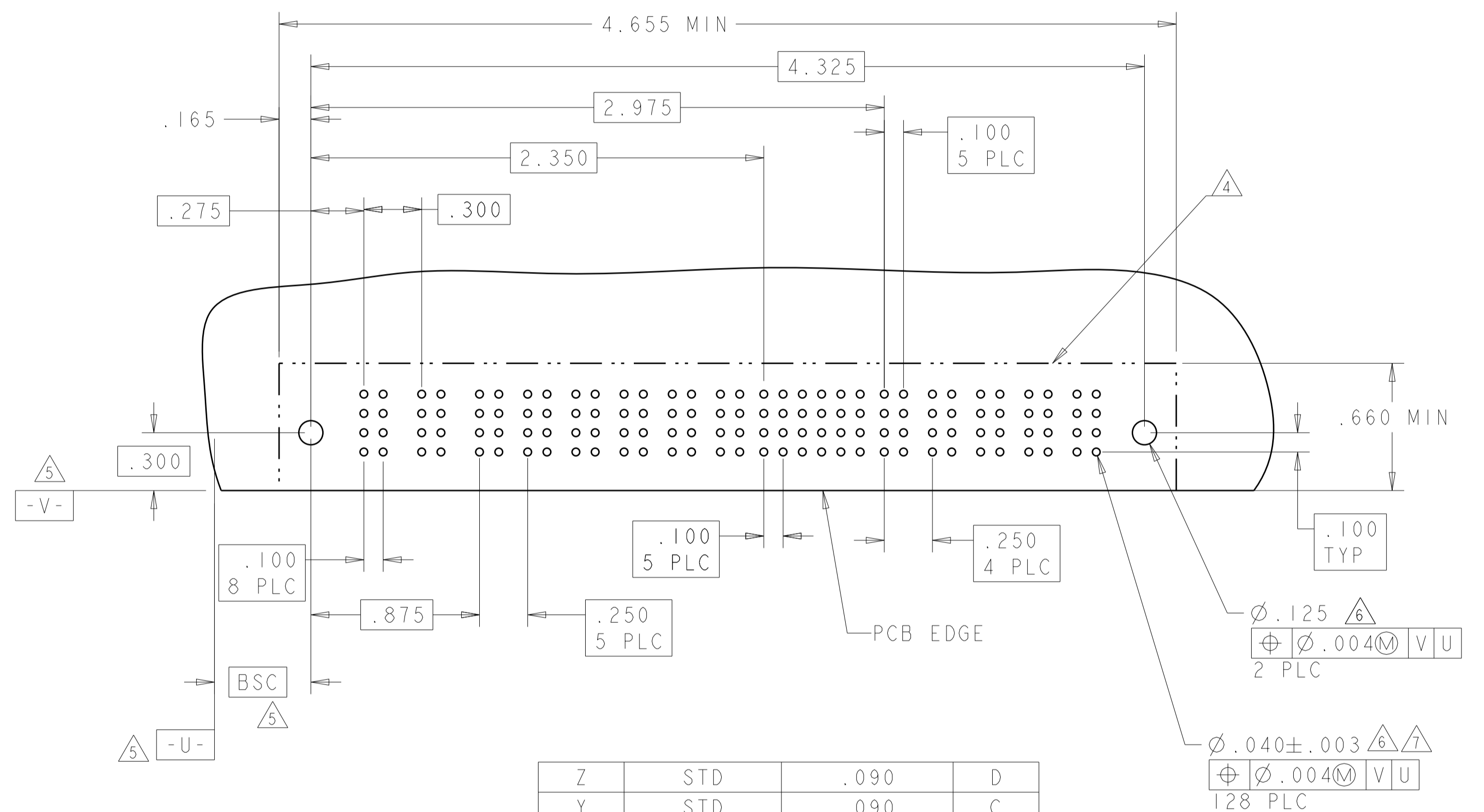
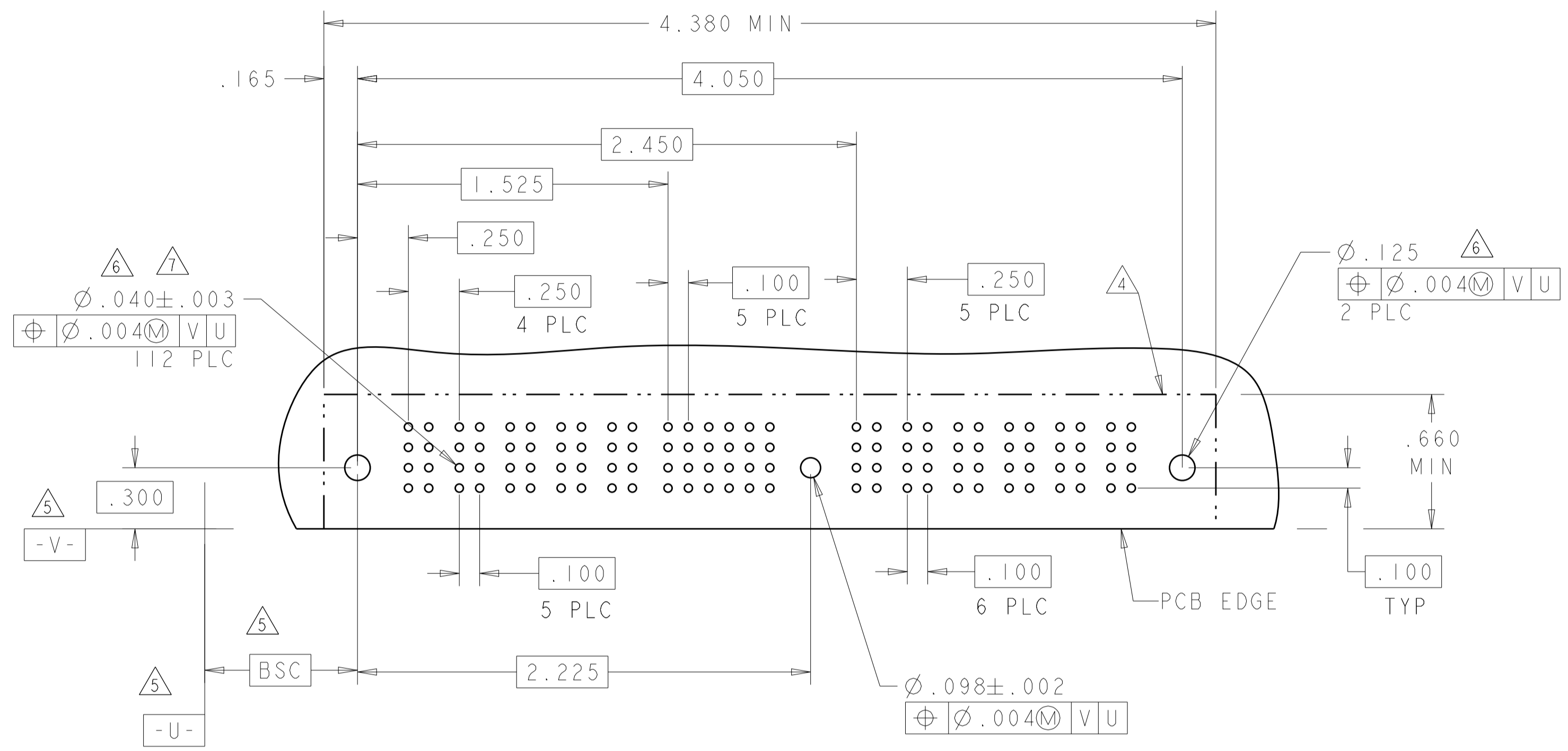

PART NUMBER	ROWS	POWER					SIGNAL						CM	POWER					
		P1	P2	P3	P4	P5	1	2	3	4	5	6		P6	P7	P8	P9	P10	P11
6450230-2	D C B A	PM	PM	PM	PM	PM	J	J	J	J	J	J		PM	PM	PM	PM	PM	PM
		PM	PM	PM	PM	PM	K	K	K	K	K	K		PM	PM	PM	PM	PM	
		PM	PM	PM	PM	PM	N	N	N	N	N	N		PM	PM	PM	PM	PM	
		PM	PM	PM	PM	PM	S	S	S	S	S	H		PM	PM	PM	PM	PM	

5P + 24S + 1M + 6P

CODE	MATING SEQUENCE	TAIL LENGTH	ROW
Z	STD	.090	D
Y	STD	.090	C
R	STD	.090	B
O	STD	.090	A
A4	MLBF	.090	D
A3	MLBF	.090	C
A2	MLBF	.090	B
A1	MLBF	.090	A
E	MLBF	.135	D
F	MLBF	.135	C
G	MLBF	.135	B
H	MLBF	.135	A
J	STD	.135	D
K	STD	.135	C
N	STD	.135	B
S	STD	.135	A

CODE	TAIL LENGTH
PM	.135
PA	.090

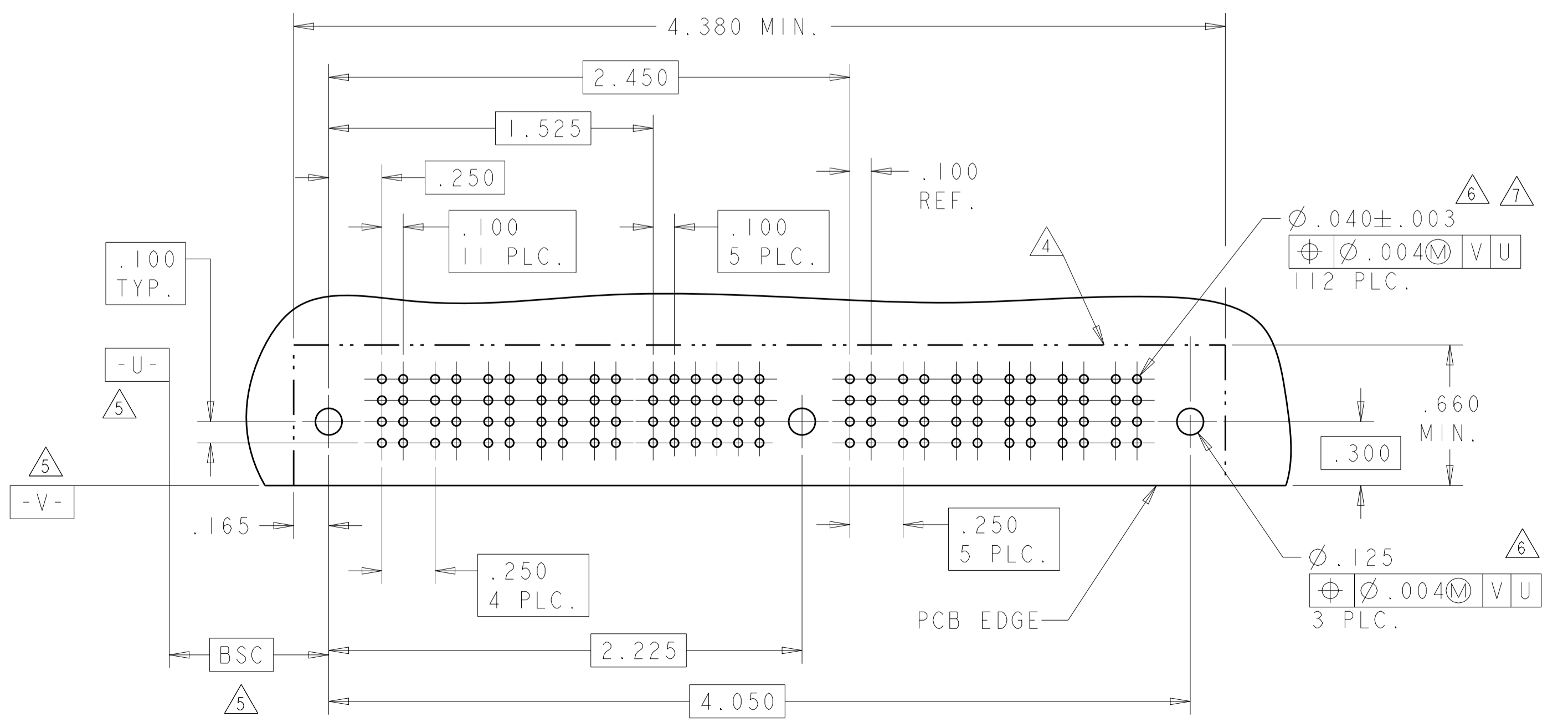

THIS DRAWING IS A CONTROLLED DOCUMENT. DWG: R.GRZYBOWSKI 22FEB05  
CHK: M.PERCHEK 22FEB05

DIMENSIONS: INCHES	TOLERANCES UNLESS OTHERWISE SPECIFIED:	APVD: M.PERCHEK	NAME: M.PERCHEK
	0 PLC ±.01	PRODUCT SPEC: 108-1973	
	1 PLC ±.01	APPLICATION SPEC: 114-13038	
	2 PLC ±.01	WEIGHT: -	
	3 PLC ±.01	CUSTOMER DRAWING	
	4 PLC ±.005		
	5 PLC ±.002		
	ANGLES ±.020		
	FINISH: -		

**STE** TE Connectivity

RIGHT ANGLE SOLDER HEADER ASSEMBLY MULTI-BEAM XL

SIZE: A1 CAGE CODE: - DRAWING NO: 6450230 RESTRICTED TO: -  
SCALE: 4:1 SHEET: 3 OF 6 REV: B3

REVISIONS				
P.	LTN.	DESCRIPTION	DATE	APVD.
-	-	SEE SHEET 1	-	-

PART NUMBER	ROWS	POWER								SIGNAL									POWER										
		P1	P2	P3	P4	P5	P6	P7	P8	1	2	3	4	5	6	7	8	9	P9	P10	P11	P12	P13	P14	P15	P16	P17		
6450230-4	D C B A	PM	PM	PM	PM	PM	PM	PM	PM	J	J	J	J	J	J	J	E	J	PM	PM	PM	PM	PM	PM	PM	PM	PM		
		K	K	K	K	K	K	K	K	K	K	K	K	K	K	K	K	K											
		N	N	N	N	N	N	N	N	N	N	N	N	N	N	N	N	N											
		S	S	S	S	S	S	S	S	S	S	S	S	S	S	S	S	S											
8P + 36S + 9P																													

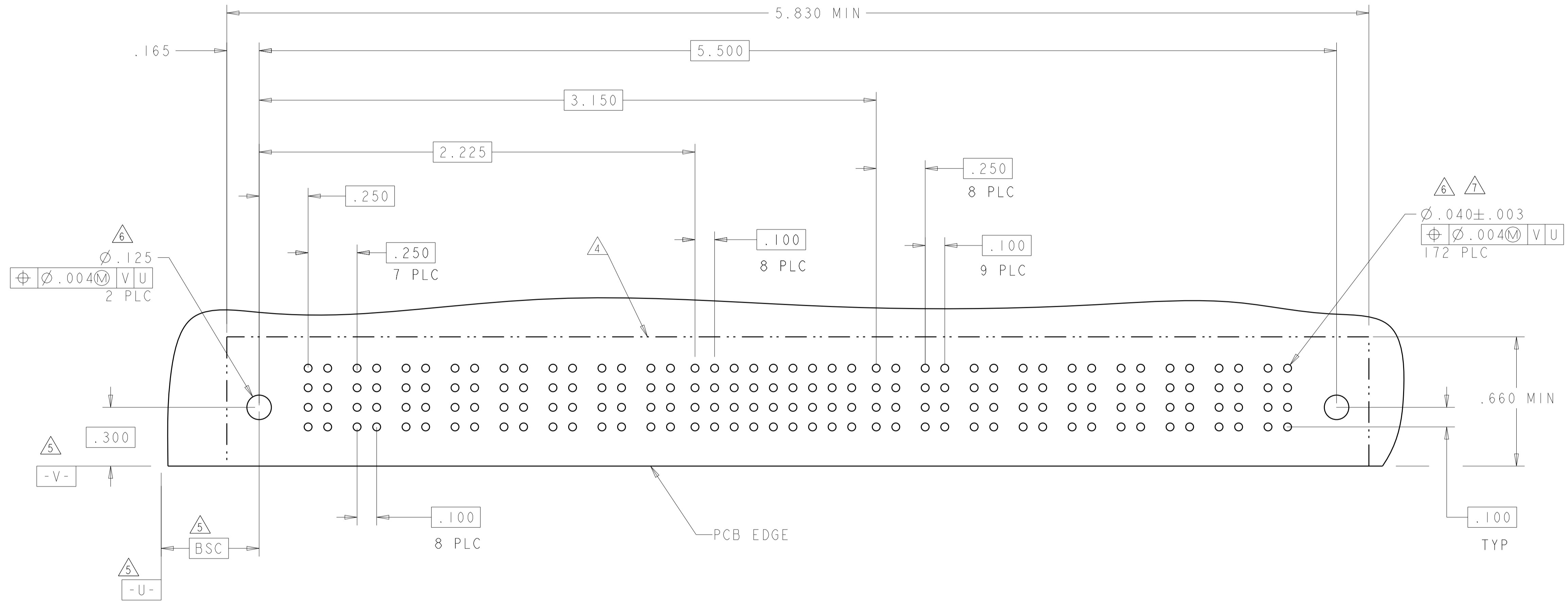

THIS DRAWING IS A CONTROLLED DOCUMENT.		OWN R. GRZYBOWSKI CHK M. PERCHERKE APVD M. PERCHERKE	22FEB05 22FEB05	TE Connectivity NAME RIGHT ANGLE SOLDER HEADER ASSEMBLY MULTI-BEAM XL
DIMENSIONS: INCHES	TOLERANCES UNLESS OTHERWISE SPECIFIED:	PRODUCT SPEC 108-1973	APPLICATION SPEC 114-13038	
MATERIAL	FINISH	WEIGHT	RESTRICTED TO	SIZE A1 CAGE CODE - DRAWING NO. 6450230 SCALE 7:2 SHEET 4 OF 6 REV B3
CUSTOMER DRAWING				

REVISIONS				
P	LTN	DESCRIPTION	DATE	APVD
-	-	SEE SHEET 1	-	-

PART NUMBER	ROWS	POWER			SIGNAL						POWER	
		P1	P2	P3	1	2	3	4	5	6	P4	P5
6450230-6	D C B A	PM	PM	PM	J	J	J	J	J	J	PM	PM
					K	K	K	K	K	K		
					N	N	N	N	N	N		
3ACP + 24S + 2P					S	S	S	S	S	S	H	

PART NUMBER	ROWS	POWER				SIGNAL								POWER							
		P1	P2	P3	P4	1	2	3	4	5	6	7	8	9	10	11	12	P4			
1-6450230-6	D	PM	PM	PM	PM	E			E	J	J	J	E								
	C					F	F	F	F		K	K	F	F							
	B					G				N	N	N	G	N							
	A					H	H	H	H	H	S	H	H								
4P + 48S + 1P																					

BLANK SIGNAL PINS ARE UNLOADED PINS

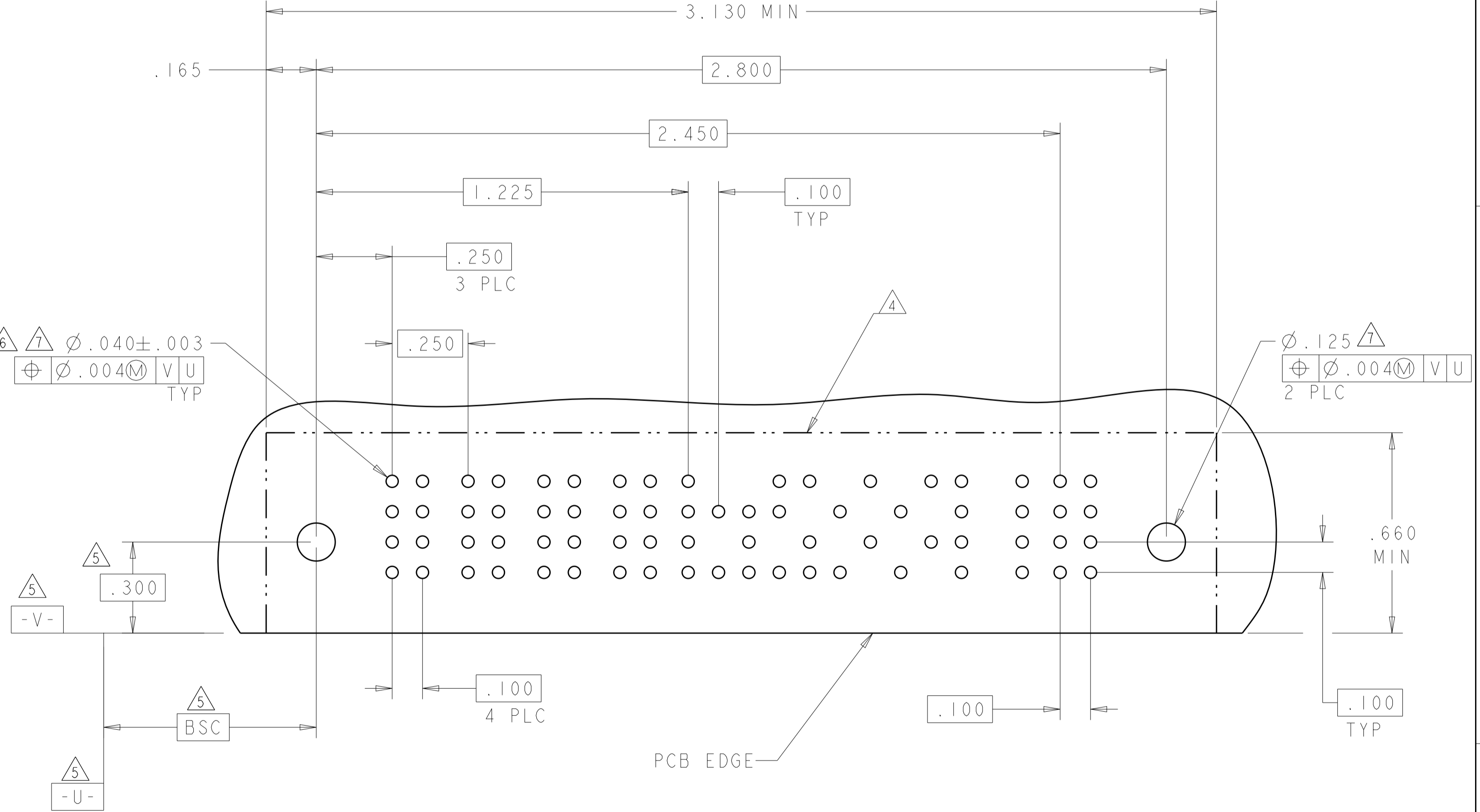
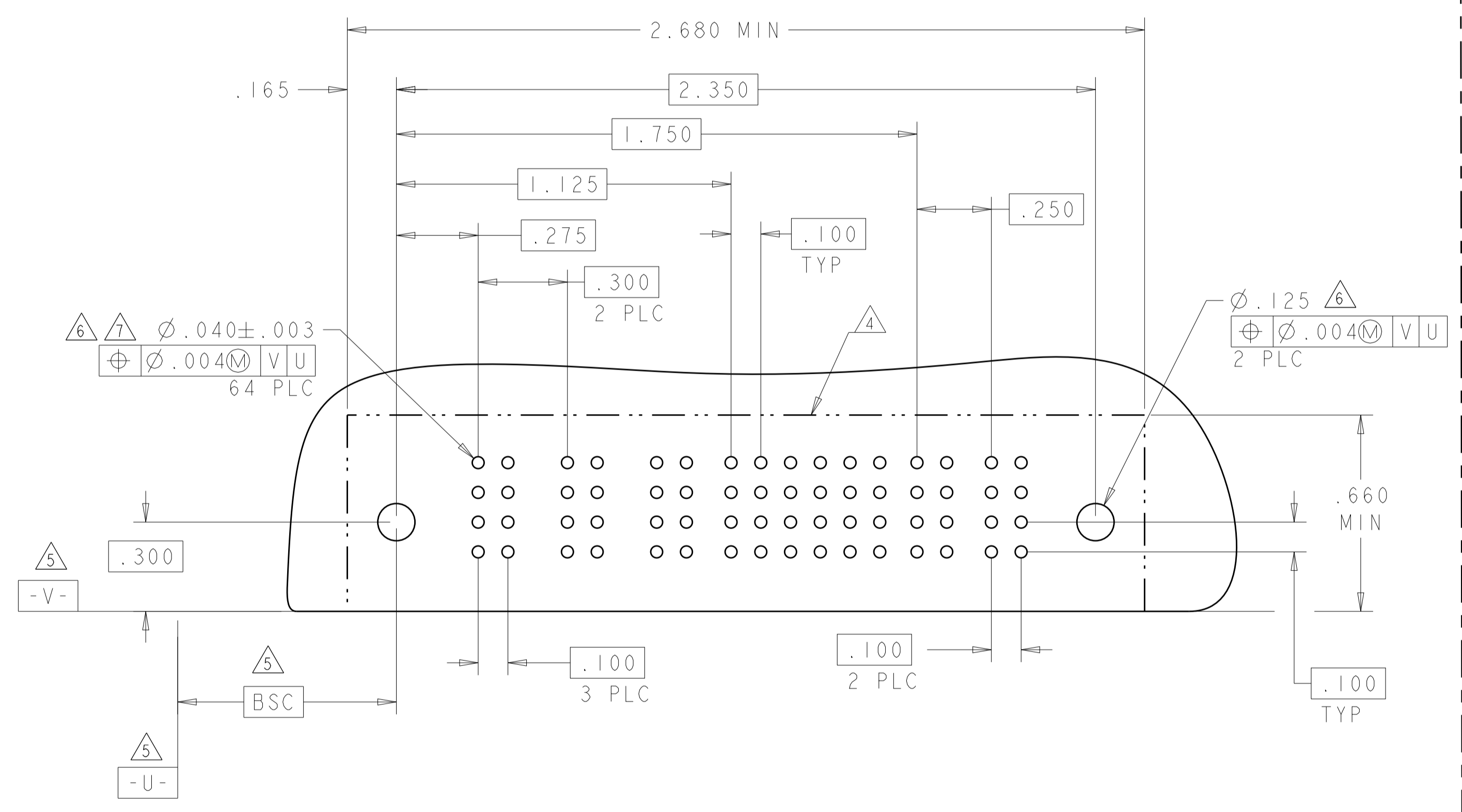

THIS DRAWING IS A CONTROLLED DOCUMENT.		DWN R. GRZYBOWSKI 22FEB05	22FEB05	<b>STE</b> TE Connectivity
DIMENSIONS: INCHES		CHK M. PERCHERKE	APVD M. PERCHERKE	
TOLERANCES UNLESS OTHERWISE SPECIFIED: 0 PLC ±. 2 PLC ±.01 3 PLC ±.005 4 PLC ±.0020 ANGLES ±.7°		NAME RIGHT ANGLE SOLDER HEADER ASSEMBLY MULTI-BEAM XL		RESTRICTED TO
MATERIAL		PRODUCT SPEC 108-1973	APPLICATION SPEC 114-13038	
FINISH		WEIGHT	SIZE A1	CAGE CODE 6450230
		CUSTOMER DRAWING	SCALE 7:2	SHEET 5 OF 6
			REV B3	

REVISIONS				
P.	LTN.	DESCRIPTION	DATE	APVD.
-	-	SEE SHEET 1	-	-

(B1)

PART NUMBER	ROWS	POWER								SIGNAL								POWER					
		P1	P2	P3	P4	P5	P6	P7	P8	1	2	3	4	5	6	7	8	P9	P10	P11	P12	P13	P14
1-6450230-5	D C B A	PM	PM		PM	PM		PM		J	J	J	J	J	J	J	J		PM	PM		PM	PM
										K	K	K	K	K	K	K	K						
										N	N	N	N	N	N	N	N						
8ACP + 32S + 6ACP										H	S	S	S	S	S	S							

NO CONTACT LOADED

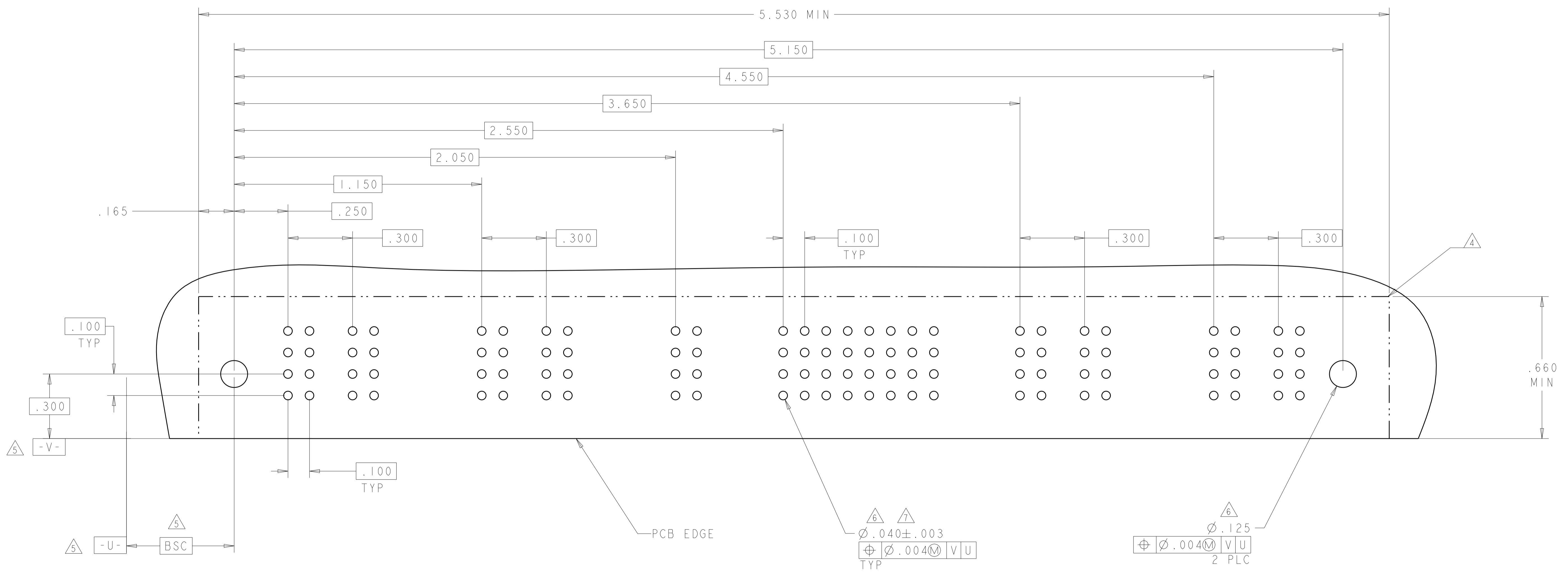

THIS DRAWING IS A CONTROLLED DOCUMENT.		DWN: R. GRZYBOWSKI 22FEB05 CHK: M. PERCHERKE 22FEB05 APVD: M. PERCHERKE	TE Connectivity
DIMENSIONS: INCHES 	TOLERANCES UNLESS OTHERWISE SPECIFIED: 0 PLC ±. 1 PLC ±.01 2 PLC ±.005 3 PLC ±.0020 ANGLES ±.2°	NAME: RIGHT ANGLE SOLDER HEADER ASSEMBLY MULTI-BEAM XL PRODUCT SPEC: 108-1973 APPLICATION SPEC: 114-13038 WEIGHT: - CUSTOMER DRAWING	SIZE: A1 CAGE CODE: - DRAWING NO: 6450230 SCALE: 7:2 SHEET: 6 OF 6 REV: B3