



---

**SUPER SEAL CONNECTOR 44 Position**

---

## 1. Purpose

Testing was performed on the Super Seal Connector to determine if it meets the requirements of Tyco specification, 108-78176-2.

## 2. Conclusion

The Super Seal Connector meets the performance requirements of Product Specification, 108-78176-2.

## 3. Test Samples

	Structure	No. of Pos.	Part Number
Cap Housing Connector	Cap Housing Assembly	44	5-6447223-7
			5-6447223-9
Plug Housing Connector	Receptacle Contact Assembly	—	3-1447221-3
		—	3-1447221-4
	Plug Housing Assembly	44	2-1447232-6 1376886-1
Accessory	Hole Plug	—	4-1437284-3

4. MEASUREMENT METHOD AND PERFORMANCE

No.	ITEM	MEASUREMENT METHOD	PERFORMANCE
4.1	External Appearance	Visual and touch feeling inspection.	There shall be no detrimental crack, rust, play, scratch, deformation and etc.
4.2	Feeling on Mating /Unmating	Feeling is verified by mating and unmating the contact, housing and connector.	There should be no detrimental binding.
4.3	Insertion Force	Pin contact or cap housing connector is fastened first, then receptacle contact or plug housing and plug connector are mated at a constant mating speed of approx. 100mm/min. or less toward the axis.	Contact Housing Connector  4.9N Max. 58.8N Max. 137.2N Max.
4.4	Withdrawal Force	Pin contact or cap housing connector is fastened first, then mated receptacle contact or plug housing and the connector is pulled at a constant speed of approx. 100mm/min. or less toward the axis. (Plug housing should be installed without locking.)	Contact Housing Connector  4.9N Max. 58.8N Max. 137.2N Max.

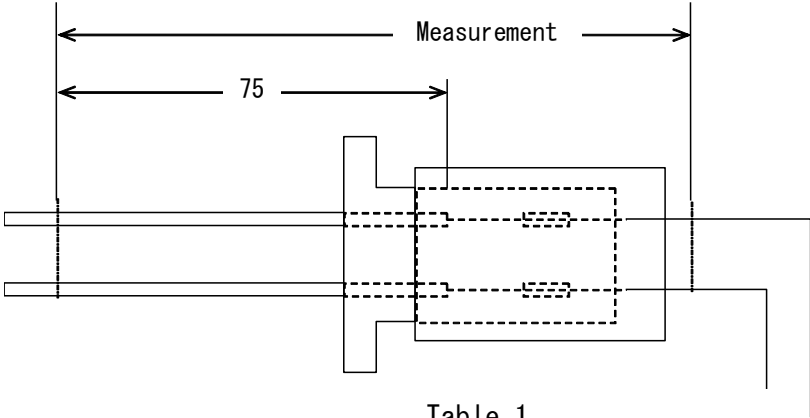
No.	ITEM	MEASUREMENT METHOD	PERFORMANCE								
4.5	Voltage Drop	<p>As shown in Fig.1 while feeding open voltage of <math>20\pm 5\text{mV}</math> and short circuit current of <math>10\pm 0.5\text{mA}</math> to the mated connector, measurement is taken at the point 75mm apart from the crimped barrel when temperature of the mated contact has saturated and then voltage drop by the wire is subtracted. (Resistance of wire is per Table 1.)</p> <p>Fig. 1</p>  <p>Table 1</p> <table border="1" data-bbox="703 1007 1189 1294"> <thead> <tr> <th data-bbox="703 1007 949 1126">Wire Size</th> <th data-bbox="949 1007 1189 1126">Resistance (<math>\text{m}\Omega / 75\text{mm}</math>)</th> </tr> </thead> <tbody> <tr> <td data-bbox="703 1126 949 1182">0.5</td> <td data-bbox="949 1126 1189 1182">2.45</td> </tr> <tr> <td data-bbox="703 1182 949 1238">0.85</td> <td data-bbox="949 1182 1189 1238">1.56</td> </tr> <tr> <td data-bbox="703 1238 949 1294">1.25</td> <td data-bbox="949 1238 1189 1294">1.07</td> </tr> </tbody> </table>	Wire Size	Resistance ( $\text{m}\Omega / 75\text{mm}$ )	0.5	2.45	0.85	1.56	1.25	1.07	<p>Initial : <math>5\text{m}\Omega</math> Max.            After Durability Test : <math>10\text{m}\Omega</math> Max.</p>
Wire Size	Resistance ( $\text{m}\Omega / 75\text{mm}$ )										
0.5	2.45										
0.85	1.56										
1.25	1.07										

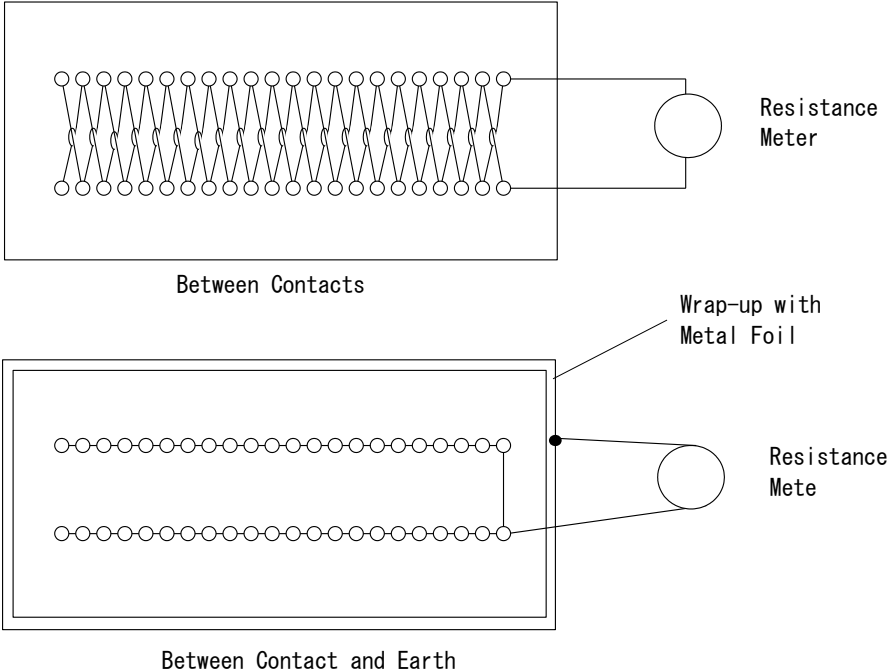
No.	ITEM	MEASUREMENT METHOD	PERFORMANCE
4.6	Insulation Resistance	<p>As shown in Fig.2 the connector is mated and insulation resistances between neighboring contacts and between contact and earth are measured with insulation resistance meter of DC 500V.</p> <p style="text-align: center;">Fig. 2</p> 	100MΩ Min.
4.7	Dielectric Withstanding Voltage	<p>As shown in Fig.2 while the connector is mated, 1000VAC or 1600V DC voltage of commercial power frequency is applied of duration of 1 minute between contacts and between contact and earth.</p>	Insulation breakdown does not develop.

No.	ITEM	MEASUREMENT METHOD	PERFORMANCE
4.8	Leak Current	<p>Peak value of leak current and integrated quantity are measured while DC 28 volt is applied with the circuit shown in Fig.3. The wire used for testing should be minimum size.</p> <p style="text-align: center;">Fig. 3</p>	<p>Peak Value : 100 <math>\mu</math> A Max.</p>

No.	ITEM	MEASUREMENT METHOD	PERFORMANCE										
4.9	Contact Solderability	Matte Tin plating only Solder bath : Sn-3Ag-0.5Cu Solder Temperature : 250±5°C Immersion Duration : 5±0.5sec. Flux : ULF-300R	Wet Solder Coverage : (Plated area only) 95% Min.										
4.10	Contact Insertion Characteristic (Between Contact and Housing)	Contact crimped on free-length of wire is inserted into the proper location of the plug housing. Holding position of the wire is 20mm apart from the crimp barrel. Insertion speed is 100mm/min. or Max.	Contact can be inserted without bending of wire.										
4.11	Contact Withdrawal Characteristic (Between Contact and Housing)	Withdraw the contact inserted under the condition of 4.10.	There shall be no detrimental binding, crack and deformation.										
4.12	Contact Retention Force (Between Contact and Housing)	About 100mm long wire is crimped with the plug housing connector and the receptacle contact is fastened and then the load that causes separation of contact from the housing with the wire pulled toward the axis at a constant speed of approx.100mm/min. is measured.	58.8N Min.										
4.13	Strength of Crimp Connection (Between Contact and Wire)	After the receptacle contact with wire crimped is fastened and then the load that causes wire breakage or separation of the wire from the crimped barrel with the wire pulled toward the axis at a constant speed of approx. 100mm/min. is measured.	<table border="0"> <tr> <td>Wire Size</td> <td></td> </tr> <tr> <td>0.5</td> <td>88.2N Min.</td> </tr> <tr> <td>0.75</td> <td>117.6N Min.</td> </tr> <tr> <td>0.85</td> <td>127.4N Min.</td> </tr> <tr> <td>1.25</td> <td>176.4N Min.</td> </tr> </table>	Wire Size		0.5	88.2N Min.	0.75	117.6N Min.	0.85	127.4N Min.	1.25	176.4N Min.
Wire Size													
0.5	88.2N Min.												
0.75	117.6N Min.												
0.85	127.4N Min.												
1.25	176.4N Min.												

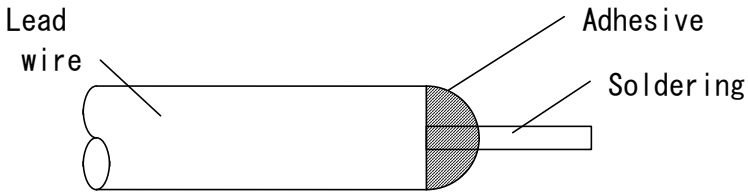
No.	ITEM	MEASUREMENT METHOD	PERFORMANCE
4. 14	Housing Retention Force (Housing Locking Strength)	After the cap housing is fastened, mated plug housing is pulled at a constant speed of approx. 100mm/min.	The lock mechanism shall not get released or broken less than 98N.
4. 15	Seal Ability	<p>Seal Ability is measured with compressed air fed into the water-proof section of the connector. Before running the test, the tip of the wire is soldered and then sealed with adhesives. (Fig. 4)</p> <p>Measurement is taken with 9.8KPa(gage) compressed air fed into the connector submerged for duration of 30 seconds. If the air does not leak for 30 seconds, the pressure is raised each time by an increment of 9.8KPa(gage).</p> <p style="text-align: center;">Fig. 4</p> 	<p>Initial : 98KPa(gage) Min.</p> <p>After Durability Test : 49KPa(gage) Min.</p>

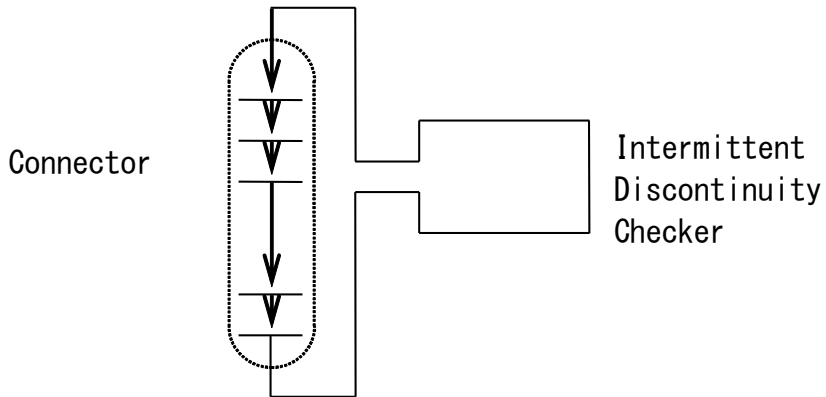
No.	ITEM	MEASUREMENT METHOD	PERFORMANCE
4.16	Temperature Rise Magnitude	<p>“Temperature Rise Test” of item No.8.16 is made and temperature of connector surface near the mated interface of the contact, is measured when the temperature has saturated.</p>	Temperature rise: 60°C Max.
4.17	Intermittent Discontinuity	<p>Power of 12V or less open voltage and 1A or less short circuit current is applied to the mated connector with the contacts in all positions connected in series and then intermittent discontinuity is monitored with an intermittent discontinuity detector. (Fig.5)</p> <p>Fig. 5</p>  <p>Connector</p> <p>Intermittent Discontinuity Checker</p>	Intermittent discontinuity shall not last for 10μsec Min.



5. TEST STRUCTURE AND SEQUENCE

5.1 Characteristic Test

The test is made basically in line with the sequence shown in the Table 3.

Table 3

Test Sample Sequence	Contact	Housing	Connector
1	External Appearance	External Appearance	External Appearance
2	Insertion Force	Insertion Force	Contact Insertion Characteristic
3	Withdrawal Force	Withdrawal Force	Insertion Force
4	Feeling on mating/unmating	Feeling on mating/unmating	Withdrawal Force
5	Contact Force	Housing Retention Force	Feeling on mating/unmating
6	—	—	Contact Withdrawal Characteristic
7	—	—	Contact Retention Force
8	—	—	Contact Solderability

5. 2 Durability Test

The test is made basically according to the Table 4.

Table 4

Sequence Group Designation	BEFORE TEST	TEST I	TEST II	TEST III
A	—	“Kojiri” durability	Vibration	Current cycle
	Low level voltage and current resistance	Low level voltage and current resistance External Appearance	Intermittent※ discontinuity※ External Appearance※ Low level voltage and current resistance	Low level voltage and current resistance External Appearance
B	—	“Kojiri” durability	Temperature rise	—
	Low level voltage and current resistance	Low level voltage and current resistance External Appearance	Temperature rise※ Low level voltage and current resistance	—
C	—	High temperature exposure	Low temperature exposure	—
	Insertion force Low level voltage and current resistance Seal ability Withdrawal force	Low level voltage and current resistance Seal ability Withdrawal force Insertion force	Low level voltage and current resistance Seal ability Withdrawal force Insertion force	—
D	—	Thermal shock	Water-Proof	—
	Insertion force Low level voltage and current resistance Seal ability Withdrawal force	Low level voltage and current resistance Seal ability Withdrawal force Insertion force	Leak current※ Low level voltage and current resistance Seal ability Withdrawal force Insertion force	—
E	—	Over-current	—	—
	External appearance	External appearance	—	—
F	—	“Kojiri” durability	Dust-proof	Oil-proof, Solvent-proof
	Insertion force Low level voltage and current resistance Insulation resistance Withdrawal force	Low level voltage and current resistance External appearance	Low level voltage and current resistance	Low level voltage and current resistance Insulation resistance Withdrawal force Insertion force External appearance
G	—	Freezing	Corrosion gas	Ozone deterioration
	Low level voltage and current resistance Insulation resistance Seal ability	Leak current	Low level voltage and current resistance Seal ability	Low level voltage and current resistance Insulation resistance Seal ability External appearance
H	—	Salt Spray	—	—
	Low level voltage and current resistance	Leak current※ Low level voltage and current resistance	—	—

Sequence Group Designation	BEFORE TEST	TEST I	TEST II	TEST III
I	—	Weather-proof	—	—
	insertion force Low level voltage and current resistance Insulation resistance Withstanding voltage Withdrawal force	Low level voltage and current resistance Insulation resistance Withstanding voltage Withdrawal force Insertion force	—	—
J	—	High pressure cleaning	—	—
	External appearance	Leak current※ External appearance	—	—

Note※: This measurement item is continually measured thru the test.

- Remark :
1. The test subject and item to be measure are shown above and below the dotted line respectively in the Table 4.
  2. The measurement items shall be measured one after another sequentially in each item.

6. TEST METHOD

6.1 “Kojiri”\*(Rocking motion) Durability Test

After the cap housing connector is fastened, the plug housing is mated in the regular manner and then 78.4N (8kgf) force is applied to-and-fro twice as shown in Fig.6. This test is repeated with the connector half if pulled from other half with slide distance stepped up by an increment of 1mm each time until the connector is fully unmated. These test procedure is defined as one cycle and is repeated 25 cycles. Test with the force applied towards right and left, is also made in the same manner. (Test with the force applied towards combined direction of to/fro and right/left is also acceptable.)

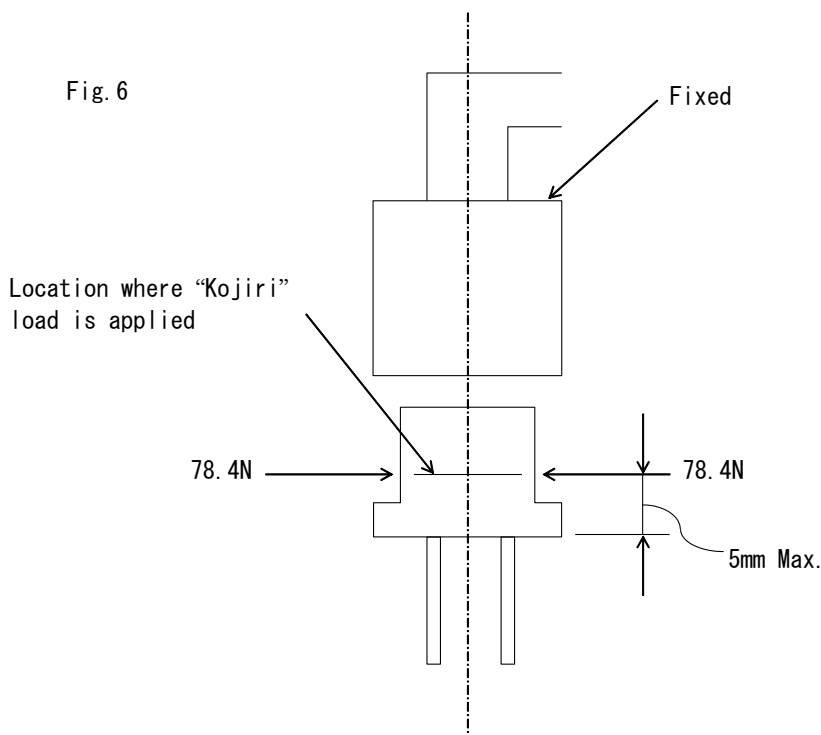

9.2 High Temperature Exposure Test

The connector is kept in a thermostatic chamber for 1000 hours and then taken out to be exposed to the normal temperature until it cools off to the temperature. The chamber temperature is set at 125°C.

9.3 Low Temperature Exposure Test

The same test procedure as above is made except that the exposure time is 150 hours and the chamber temperature is set at -40°C.



### 6.6 Oil-Proof, Solvent-Proof Test

The connector is dipped in various oil. Oil temperature is set at  $50\pm 2^{\circ}\text{C}$ .

Test is made in the sequence shown below.

- |   |   |
|---|---|
| Torq. Con. Oil<br>(Castle Auto Fluid Special) | Dipping for 1hour → Dipping in kerosene for 5min. |
| → Transmission Oil (SAE 90)                   | Dipping for 1hour → Dipping in kerosene for 5min. |
| → Engine Oil (SAE 10W-30)                     | Dipping for 1hour → Dipping in kerosene for 5min. |
| → Clutch oil<br>(Toyota Standard SHD)         | Dipping for 1hour → Dipping in kerosene for 5min. |
| → Brake Oil<br>(Toyota Standard SHF)          | Dipping for 1hour → Dipping in kerosene for 5min. |

Another dipping test is also made on other sample in the following sequence with oil temperature set at  $50\pm 2^{\circ}\text{C}$ .

Washer liquid (available in the market) Dipping for 1hour

- Rinsing and dipping with or in tap water for 5min.
- Antifreezing solution (Castle Long Life Coolant) Dipping for 1hour
- Rinsing and dipping with/or in tap water 5min.
- Drying while left in room temperature

### 6.7 Water-Proof Test

The connector is placed in the thermostatic chamber, heated up 40min. and then immediately sprayed with water of normal temp. for 20min. in an water-proof test chamber. This is defined as 1cycle. The cycle is repeated 48 times for the test. The spray is made according to S2 of JIS D0203. Potential of 28 volt is applied across each contact of the connector during the water spray by the circuit shown in the Fig. 3 and leak current is monitored. At running the test, the leading end of the lead wire shall be pulled out from the test chamber after having been soldered and then sealed with adhesives. The thermostatic chamber is set at 125°C.

### 6.8 Freezing Test

The conector is put in a thermostatic chamber set at  $-30 \pm 5^{\circ}\text{C}$  immediately after dipped in boiling water for 1hour and then taken out of the chamber after the water stuck on the connector has freezed. Potential of 28 volts is applied across each contact of the conector during the test with the circuit shown in Fig.3, and leak current is monitored.

### 6.9 Corrosion Gas Test

The connector is left in the test chamber for 24hours. The chamber is fed with 10ppmSO<sub>2</sub> gas with 90% or more humidity and set at normal temperature.

### 6.10 Ozone Deterioration Test

The connector is left in the test chamber for 24hours. The chamber is fed with  $50 \pm 5$ ppm ozone gas and set at 40°C.

6.11 Vibration Test at High Temperature

The connector is fastened to vibration stand and vibrated on each of the 3 mutually perpendicular axis (X, Y, Z) in 125°C atmosphere. Other condition of the vibration is set by the Table 5. During the test, electrical current is turned on as shown in Fig. 8 and intermittent discontinuity is monitored.

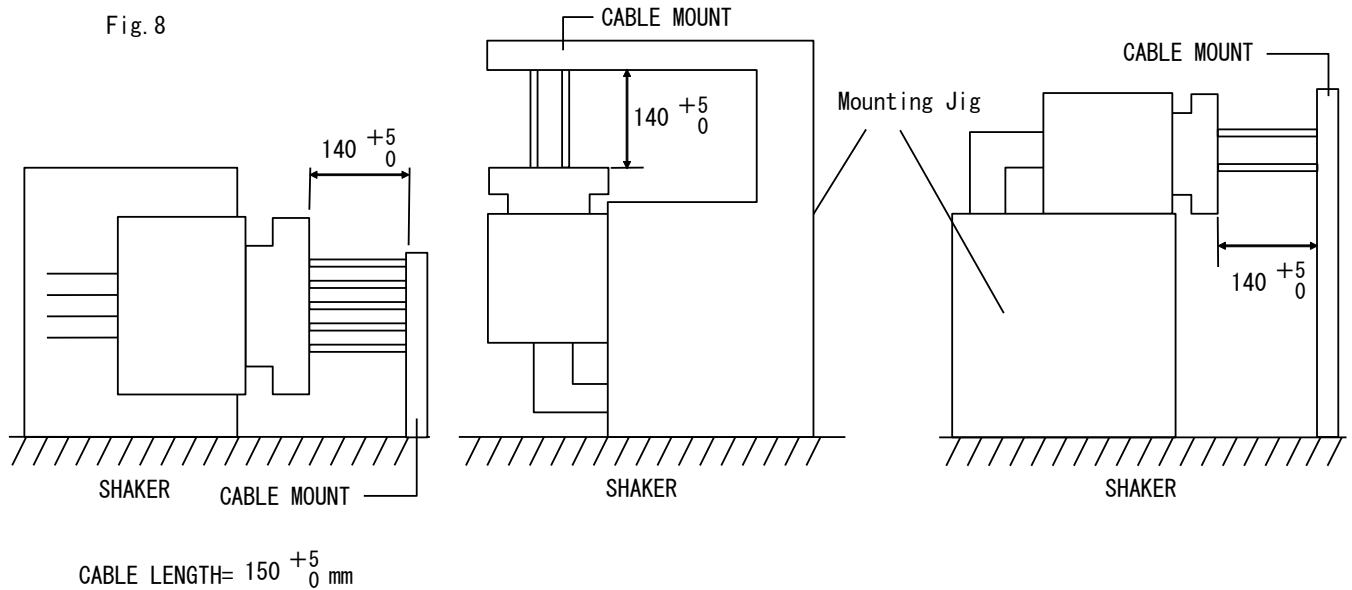
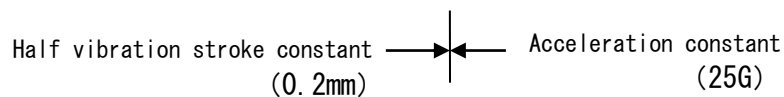

Table 5

Acceleration (m/s <sup>2</sup> )	Vibration Duration (h)	Vibration Frequency (Hz)
98~245 (10~25G)	3 hours per direction, Total of 9 hours	50~100 ... 98m/s <sup>2</sup> (10G) constant 100~250* ... Half vibration stroke of 0.2mm constant ~245m/s <sup>2</sup> (25G) constant Sweep Time 3min. (Log Sweep)

\* 100~176~250Hz





6.12 Weather-Proof Test

The connector is left in sunny outdoors for 12 months.

6.13 Current Cycle Test

① Contacts of signal positions of the connector are turned on with the current of 3 Ampere, and power positions with the current of 4 Ampere. Turning on current for 45 min. and then turning off for 15 min. are defined here as one cycle of test. The connector is tested with 200 cycles.

② Contacts of signal positions of the connector are turned on with the current of 3 Ampere and power positions with the current of 8 Ampere shown in fig. 9 at 120°C atmosphere. This test cycle is repeated 50 times with vibration applied in draft free chamber according to the condition specified in the Table 5. The connector is vibrated perpendicular to the terminal axis.

Fig. 9

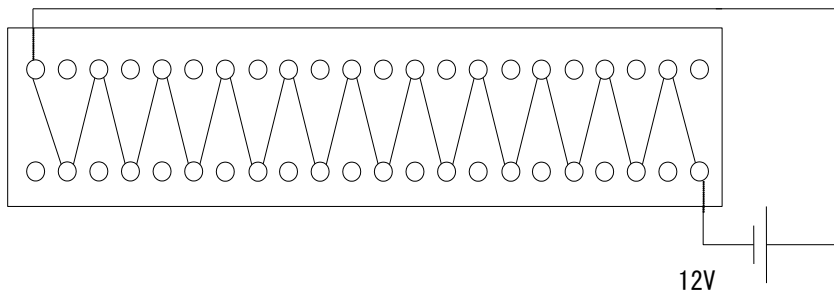

6.14 Over-current Test

While the connector is held horizontally in a draft free chamber, current is turned on thru one circuit arbitrarily chosen. Current magnitude and time length for the over-current test are selected per the Table 6

Table 6

Wire Size	Test ①		Test ②	
	Current Value (A)	Conduction Time (min.)	Current Value (A)	Conduction Time (sec.)
0.5	30	5	80	5
0.85	40		110	
1.25	50		170	

6.15 Dust-Proof Test

Hang the mated connector in the chamber of 900~1200mm each sides. Jet 10 seconds the 1.5Kg of powder specified by JIS Z8901-6 in every 15 minutes. This test cycle is repeated 8 cycles. Unmated and mate the connector in every 2 cycles.

6.16 Temperature Rise Test

Conduct the current of 15 Ampere on an optional contact of the connector, then conduct the current of 6 Ampere on all of the contact. Measurement is based on per temperature rise magnitude 6.16.

6.17 High-Pressure Cleaning Test

Conduct the test accordance with condition specified by Fig. 7 immediate after keeping in 100°C thermostatic chamber for 10 or more minutes. 10 times repeat this test after cooling in room temperature for one minute for each. The cleaning is made around at portion A and B from 60° against the fixed sample. See Fig. 10

- A: Cable sealing area
- B: Connector dealing area

Do not reuse the samples for cleaning for A or B.

Fig.10

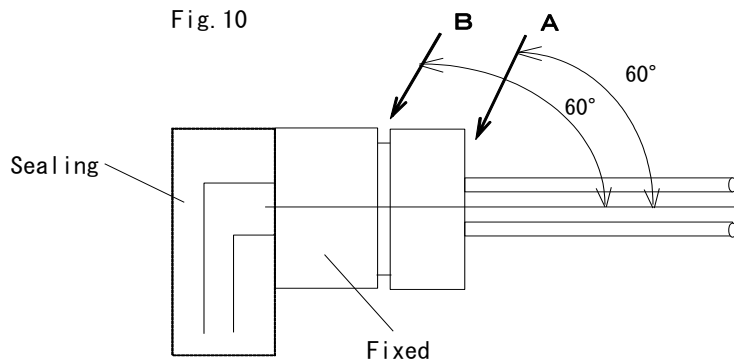

Leak current is measured during the cleaning para 4.8.

Table 7

Item	Requirement
Discharge water pressure	7840 KPa (80 Kgf/cm <sup>2</sup> ) (Default of washer)
Discharge water volume	600ℓ/h以上
Distance from the nozzle	300mm
Cleaning time	30 sec

## 7. TEST CONDITION

- (1) Contact and housing to be tested are to be selected randomly.
- (2) Contact and housing to be tested are to be crimped with wire of the maximum size except when otherwise noted. Wire length shall be decided each time.
- (3) Wire used in the tests should have enough performance of Heatstability and Solvent-resistance.
- (4) Test is to be made in the normal temperature and humidity except when otherwise noted.
- (5) Test is to be made with the connector mated except when otherwise noted.
- (6) Tolerance of the test conditions is  $\pm 10\%$  except when otherwise noted.
- (7) Quantity of test sample will be adjusted depending on situation.
- (8) Measurement for each test is to be made on 2 positions or more.

8. TEST RESULT

8.1 Characteristic Test

Unit : N

Test Sample		Contact			
Test		n	max.	$\bar{x}$	min.
External Appearance / There shall be no detrimental Crack, rust, play, scratch Deformation. (Visual, Feeling)		10	OK		
Insertion Force / 4.9N Max.		10	2.50	1.83	1.27
Withdrawal Force / 4.9N Max.		10	2.16	1.66	1.37
Feeling on Mating/Unmating / There should be no Detrimental binding		10	OK		
Crimp Strength	0.5      88.2N Min.	10	129	120	116
	0.85      127.4N Min.	8	184	162	138
	1.25      176.4N Min.	9	221	203	186



Test	Test Sample		Connector				Housing							
			n	max.	ave.	min.	n	max.	ave.	min.				
External Appearance	There shall be no detrimental Crack, rust, play, scratch Deformation. (Visual, Feeling)		5	OK			5	OK						
Contact Insertion Characteristic	Contact can be inserted without bending of wire		44	Inserted with no bending			/							
Insertion Force (N)	137.2N (14kgf) Max.		12	116	110	106					Omit			
Low Level Voltage and Current Resistance (mΩ)	5 mΩ Max.		792	2.3	2.0	1.8								
Insulation Resistance (MΩ)	100 MΩ Min. (DC500V)	Between contact	8	6.1E+05	3.4E+05	5.1E+04								
			8	9.3E+06	1.3E+06	1.6E+04								
Dielectric Withstanding Voltage	Insulation breakdown does not develop (AC1000V)	Between earth	8	OK										
			8	OK										
Seal Ability	98K Pa(1kg/cm2) Min.		44	OK										
Withdrawal Force (N)	137.2N(14kgf)以下		12	119	115	107					Omit			
Feeling on Mating/Unmating	There should be no Detrimental binding		5	OK							5	OK		
Contact Withdrawal Characteristic	There shall be no detrimental binding, crack and deformation		44	OK										
Contact Retention Force (N)	58.8N (6kgf) Min.		8	108	87	71								
Contact Solderbility			44	OK										

8.2 ENDURANCE TEST

A Group

		Initial	“Kojiri” Durability	Vibration	Current Cycle 1	Current Cycle 2
Low Level Voltage and Current Resistance Unit : mΩ ( n=88ピン )	Spec.	5mΩ Max.	10mΩ Max.	10mΩ Max.	10mΩ Max.	10mΩ Max.
	Max.	2.3	2.7	7.4	6.3	7.6
	Ave.	2.0	2.1	2.3	2.8	3.2
	Min.	1.6	1.7	1.5	1.7	2.4
External Appearance ( n=2 Set )		/	OK	OK	OK	OK
Instantaneous Interruption ( n=2 Set )	Spec.	/	/	1 Max.	/	/
	10μ sec Max.	/	/		/	/

B Group

		Initial	“Kojiri” Durability	Temperature Rise
Low Level Voltage and Current Resistance Unit : mΩ ( n=44 Pin )	Spec.	5mΩ Max.	10mΩ Max.	10mΩ Max.
	Max.	2.2	2.7	2.8
	Ave.	1.9	2.1	2.3
	Min.	1.6	1.6	1.6
External Appearance ( n=1 Set )		/	OK	OK
Temperature Rise Unit : °C ( n=6 Pin ) Spec: 60°C Max.	15A Single Circuit	Max.	/	33.4
		Ave.	/	30.5
		Min.	/	27.8
	6A All Circuit	Max.	/	49.2
		Ave.	/	41.7
		Min.	/	28.3

C. Group

		Initial	High Temperature Exposure	Low Temperature Storage
Low Level Voltage and Current Resistance Unit : mΩ ( n=132 Pin )	Spec.	5mΩ 以下	10mΩ 以下	10mΩ 以下
	Max.	2.1	2.4	2.8
	Ave.	1.8	1.9	2.0
	Min.	1.5	1.7	1.7
Insertion Force Unit: N ( n=4 Set ) Spec.: 137N Max.	Max.	116	108	111
	Ave.	114	102	102
	Min.	111	97	96
Withdrawal Force Unit: N ( n=4 Set ) Spec: 137N Max.	Max.	118	71	77
	Ave.	117	66	66
	Min.	116	62	54
Seal Ability ( n=5 Set )	Spec.	98Kpa Min.	49Kpa Min.	49Kpa Min.
		OK	OK	OK

D. Group

		Initial	Thermal Shock	Water Proof
Low Voltage Current Resistance Unit : mΩ ( n=132 Pin )	Spec.	5mΩ Max.	10mΩ Max.	10mΩ Max.
	Max.	2.1	2.7	2.2
	Ave.	1.8	2.0	1.8
	Min.	1.5	1.6	1.5
Insertion Force Unit: N ( n=4 Set ) Spec: 137.2 N Max.	Max.	110	84	134
	Abe.	109	81	121
	Min.	106	79	106
Withdrawal Force Unit: N ( n=4 Set ) Spec: 137.2 N Max.	Max.	118	81	98
	Abe.	116	78	90
	Min.	114	77	83
Seal Ability ( n=5 Set )	Spec.	98Kpa Min.	49Kpa Min.	49Kpa Min.
		OK	OK	OK
Leak Current Unit: μA ( n=5 Set ) Spec : 100 μA Max.		/	/	1 Max.

E. Group

Wire 0.5 (n=2)	No ignition on housing
Wire 0.85 (n=2)	No ignition on housing
Wire 1.25 (n=2)	No ignition on housing

F Group

		Initial	“Kojiri” Durability	Dust Proof	Oil Proof	Solvent Proof
Low Voltage Current Resistance Unit : mΩ ( n=132 Pin )	Spec.	5mΩ Max.	10mΩ Max.	10mΩ Max.	10mΩ Max.	10mΩ Max.
	Max.	2.2	2.5	2.5	2.1	2.8
	Ave.	1.9	1.9	1.9	1.9	2.0
	Min.	1.7	1.5	1.6	1.7	1.6
Insertion Force Unit : N ( n=4 Set ) Spec : 137.2 N Max.	Max.	108	/	/	131	132
	Ave.	107			126	126
	Min.	106			121	121
Withdrawal Force Unit : N ( n=4 Set ) Spec. : 137.2 N Max.	Max.	119	/	/	133	131
	Ave.	112			128	127
	Min.	107			123	124
Insulation Resistance (Between pins) Unit : MΩ ( n=4 Set ) Spec : 100MΩ Min.	Max.	6.1E+05	/	/	2.4E+05	1.5E+07
	Ave.	4.8E+05			1.2E+05	1.1E+07
	Min.	2.0E+05			3.6E+02	7.7E+06
Insulation Resistance (Between pin and ground) Unit : MΩ (n=4 Set) Spec. : 100MΩ Min.	Max.	9.3E+06	/	/	6.8E+05	6.9E+06
	Ave.	2.5E+06			5.2E+05	5.6E+06
	Min.	8.3E+04			3.6E+05	4.3E+06

G Group

		Initial	Freeze	Corrosion Gas	Ozone Deterioration
Low Voltage Current Resistance Unit : mΩ ( n=132 Pin )	Spec.	5mΩ Max.	10mΩ Max.	10mΩ Max.	10mΩ Max.
	Max.	2.1	2.2	2.2	2.3
	Ave.	1.9	1.9	1.9	1.9
	Min.	1.6	1.6	1.6	1.6
Seal Ability ( n=5 Set )	Spec.	98Kpa Min.	/	49Kpa Min.	49Kpa Min.
		OK		OK	OK
Insulation Resistance (Between pins) Unit : MΩ (n=4 Set) Spec. : 100MΩ Min.	Max.	5.0E+05	/	/	1.8E+07
	Ave.	2.1E+05			5.4E+06
	Min.	5.1E+04			2.3E+04
Insulation Resistance (Between pin and ground) Unit : MΩ (n=4 Set) Spec. : 100MΩ Min.	Max.	1.1E+05	/	/	7.8E+07
	Ave.	6.1E+04			3.5E+07
	Min.	1.6E+04			1.8E+06
Leak Current Unit : μA ( n=5 Set ) Spec. : 100 μA Max.		/	1 Max.	/	/



H Group

		Initial	Salt Spray
Low Voltage Current resistance Unit : $m\Omega$ ( n=132 Pin )	Spec.	5m $\Omega$ Max.	10m $\Omega$ Max.
	Max.	2.2	2.6
	Ave.	1.9	2.0
	Min.	1.7	1.8
Leak Current Unit : $\mu A$ ( n=5 Set) Spec : 100 $\mu A$ Max.		/	1 Max.

I Group  
Under Examination

J Group

	High pressure cleaning
Leak Current (Wire Seal Area) Unit : $\mu A$ ( n=5 Set) Spec : 100 $\mu A$ Max.	1 Max.
Leak Current (Connector Seal Area) Unit : $\mu A$ ( n=5 Set ) Spec. : 100 $\mu A$ Max.	1 Max.