

Part Number	Description	Cable
1408149-1	MMCX Right-Angle Cable Plug Connector	RG178/196
1408149-2	MMCX Right-Angle Cable Plug Connector	RG316
1408149-3	MMCX Right-Angle Cable Plug Connector	RD316
1408149-4	MMCX Right-Angle Cable Plug Connector	OMNI-FLEX 200

Figure 1

1. INTRODUCTION

This instruction sheet contains the assembly procedure for the MMCX Right-Angle Cable Plug Connectors listed in Figure 1. These connectors are crimp attachment type connectors that attach to the flexible cable listed in Figure 1.

The table in Figure 2 references the crimp tooling used to apply these connectors. The table includes tool descriptions, the part number, and the crimp configuration for the tooling.

Tool Description	Part Number	Crimp Configuration Ferrule (Hex)
PRO-CRIMPER* III Hand Tool Frame	354940-1	--
Crimp Die (RG178, RG196)	1583696-1	2.67 [.105]
Crimp Die (RG316)		3.25 [.128]
Crimp Die (RD316)		3.86 [.151]
Crimp Die for OMNI-FLEX 200		2.67 [.105]

Figure 2

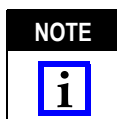

Dimensions in this instruction sheet are in metric units [with U.S. customary units in brackets]. Figures are not drawn to scale.

Reasons for revision can be found in Section 4.

2. DESCRIPTION

Each MMCX Right-Angle Cable Plug Connector consists of a housing assembly, a crimp ferrule, and a cap. See Figure 1. Also included is shrink tubing (for use with OMNI-FLEX 200 cable only.)

3. ASSEMBLY PROCEDURE

- Slide the crimp ferrule onto the cable.

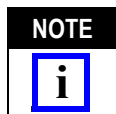

To avoid personal injury, be sure to use appropriate safety equipment, including gloves, when using cable stripping tools.

- Strip the cable according to the dimensions in Figure 3.



Do NOT damage the cable braid, dielectric, or inner conductor of the cable.

- Flare the cable braid and push the housing assembly over the inner conductor (under the cable braid). See Figure 4.

- Slide the crimp ferrule back over the cable braid and housing assembly until the inner conductor is positioned in the center contact slot. See Figure 4.

- Crimp using the tooling listed in Figure 2. See Figure 5.

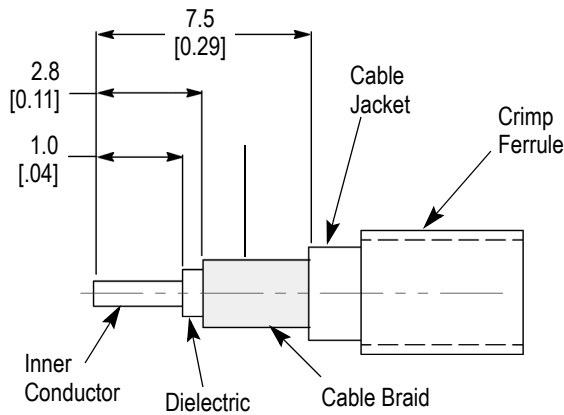
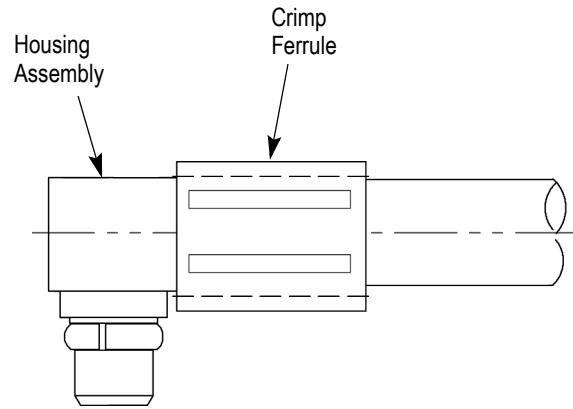

Figure 3



Crimp Using the Tooling in Figure 2

Figure 5

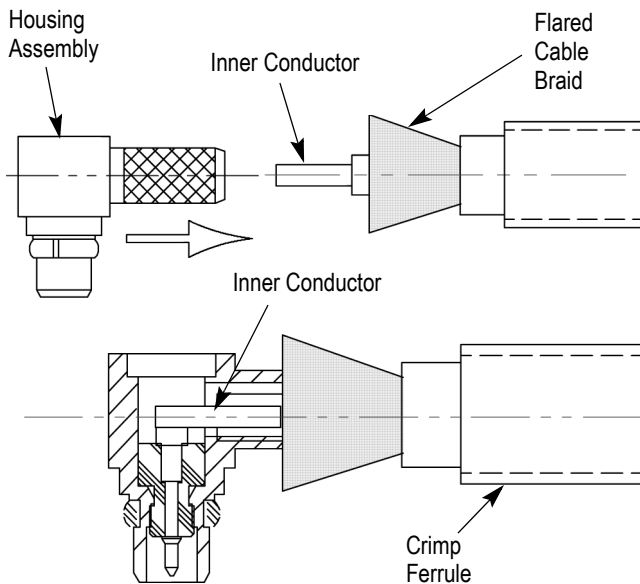

Figure 4

6. Solder the cable inner conductor to the center contact in the housing assembly.



To avoid personal injury, be sure to exercise caution when handling hot soldering equipment.

7. Place cap on top of the housing assembly as shown in Figure 6. Press the cap firmly in place.

8. For OMNI-FLEX 200 cable only -- Slide shrink tubing over the cable and crimped ferrule. Heat the shrink tubing and shrink it into place. See Figure 7.

4. REVISION SUMMARY

- Updated document to corporate requirements.

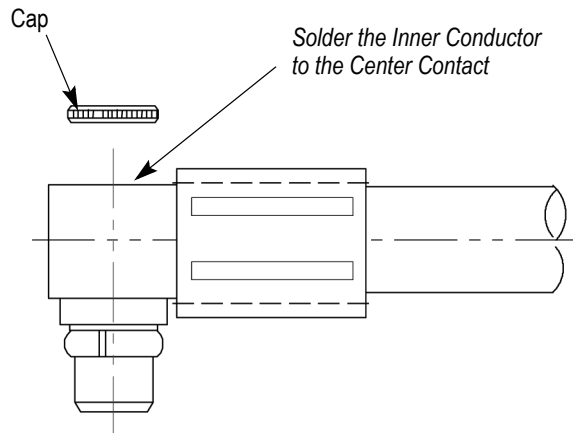

Figure 6

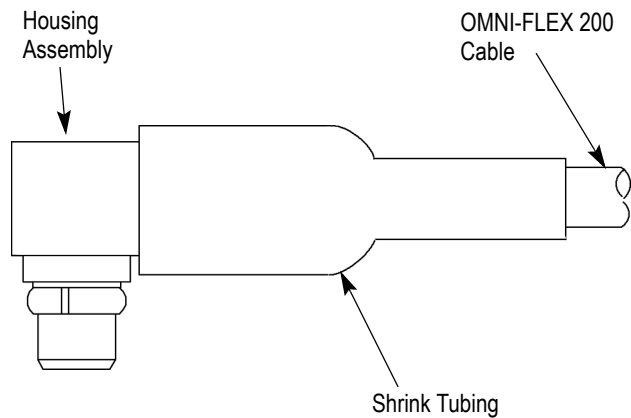

Figure 7