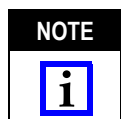

Figure 1

1. INTRODUCTION

This TE Connectivity instruction sheet covers the assembly procedures for Metal Shell CPC (Circular Plastic Connectors) listed in Selection Charts 1 through 4. Typical connector configurations are shown in Figure 1.

Read this sheet carefully, and applicable referenced material, before assembling connector or installing hardware.



Dimensions in this instruction sheet are in metric units [with U.S. customary units in brackets]. Figures are not drawn to scale.

Reasons for revision are shown in Section 7, REVISION SUMMARY.

2. DESCRIPTION

Each connector consists of a circular plastic contact housing and metal shell. The connector series number is an indicator of the size and/or type of contacts specified for the connector. See Selection Charts 1 through 4 for the four connector series.

Series 1 connectors (Selection Chart 1) are available in three shell sizes (14, 22, and 28) and accept a mixture of TYPE III+ and Subminiature COAXICON* contacts.

Series 2 connectors (Selection Chart 2) are available in two shell sizes (22 and 28) and accept 20 DM and 20 DF contacts.

Series 3 connectors (Selection Chart 3) are available in two shell sizes (22 and 28) and accept Type XII Power contacts.

Series 4 connectors (Selection Chart 4) are available in one shell size (28) and accept a mixture of Type XII Power contacts from Series 3 and size 16 contacts previously mentioned for Series 1 connectors.

The connector designator indicates the industry standard size and contact positions of the connector. For example, 22/14 means size 22, which is the outside diameter in 16ths of an inch as measured across the coupling threads, and contact positions 14, meaning the number of contact cavities in the connector.

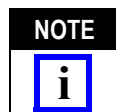

The industry standard connectors are measured across machined threads, whereas the CPC connectors are measured across molded quick-connect/disconnect threads. They are exact equivalents of each other. See Figure 2.

3. CONNECTOR SELECTION

Using the Selection Charts and Paragraph 2, DESCRIPTION, determine the appropriate connectors to be used by the following method. Determine: application requirements(series 1, 2, 3 and 4); number of required contact positions; connector style (standard or reverse); and receptacle and plug housings.

Series 1 Connectors				Recommended Contacts
Des	Sex	Housing		
		Descr	Part No.	
14/7	Std	Plug	208714-1	Type III+, and Subminiature COAXICON Contacts; (See Fig. 3) (See 408-1379 and Catalog CPC/CMC 73-204)
		Rcpt	208715-1	
	Rvs	Plug	208716-1	
		Rcpt	208717-1	
14/5	Std	Plug	208718-1	
		Rcpt	208719-1	
	Rvs	Plug	208720-1	
		Rcpt	208721-1	
22/14	Rvs	Plug	208486-1	
	Rvs	Rcpt	208487-1	
22/16	Std	Plug	208488-1	
		Rcpt	208489-1	
28/24	Std	Plug	208457-1	
		Rcpt	208459-1	
28/37	Std	Plug	208470-1	
		Rcpt	208471-1	
	Rvs	Plug	208472-1	
		Rcpt	208473-1	

Selection Chart 1

Series 2 Connectors				Recommended Contacts
Des	Sex	Housing		
		Descr	Part No.	
22/28	Std	Plug	208490-1	Size 20 DM and DF (See Fig. 4) (See 408-1379 and Catalog CPC/CMC 73-204)
		Rcpt	208491-1	
	Rvs	Plug	208492-1	
		Rcpt	208493-1	
28/57	Rvs	Plug	208474-1	
		Rcpt	208475-1	
28/63	Std	Plug	208476-1	
		Rcpt	208477-1	

Selection Chart 2

Series 3 Connectors				Recommended Contacts
Des	Sex	Housing		
		Descr	Part No.	
22/3	Std	Plug	208494-1	Type XII (See Fig. 5) (See 408-1379 and Catalog CPC/CMC 73-204)
		Rcpt	208495-1	
	Rvs	Plug	208496-1	
		Rcpt	208497-1	
28/7	Std	Plug	208482-1	
		Rcpt	208483-1	
	Rvs	Plug	208484-1	
		Rcpt	208485-1	

Selection Chart 3

Series 4 Connectors				Recommended Contacts
Des	Sex	Housing		
		Descr	Part No.	
28/16	Std	Plug	208478-1	Multimate Contacts and Type XII Power Contacts (See 408-1379 and Catalog CPC/CMC 73-204)
		Rcpt	208479-1	
28/22		Plug	208480-1	
		Rcpt	208481-1	
28/13	Std	Plug	211822-1	
		Rcpt	211823-1	

Selection Chart 4

4. CONTACTS

Selection - When selecting contacts, according to the connector Selection Charts on this sheet, refer to Catalog CPC/CMC 73-204. For visual identification of the proper contacts to be used in the various connector series, see Figures 2, 3, 4, and 5.

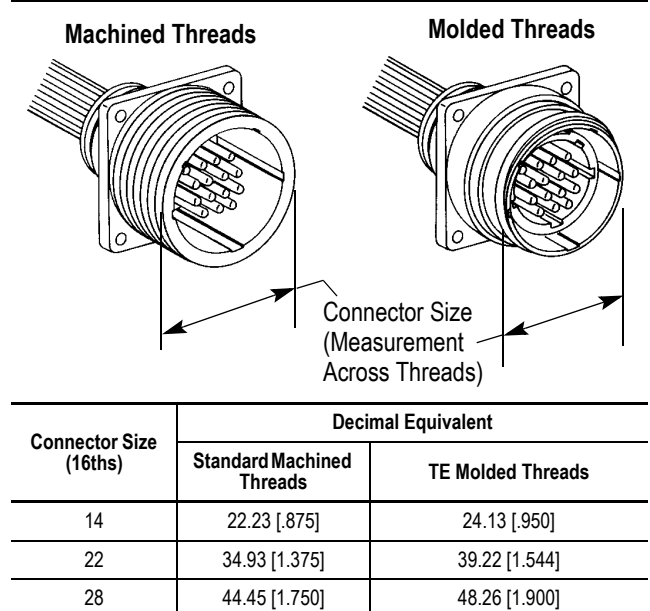
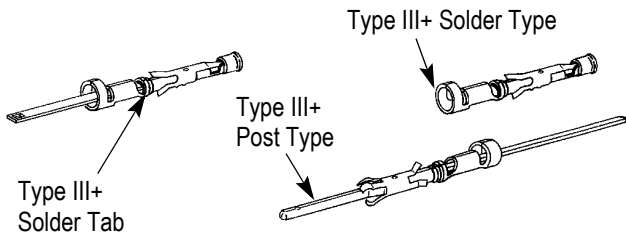

Figure 2

Multimate Contacts



Crimp-Type Contacts (Typ)

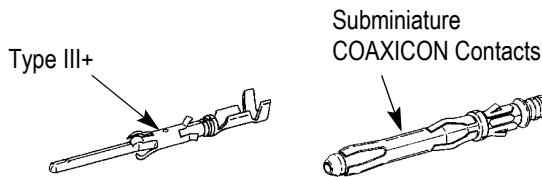

Figure 3

For contacts used in Series 1 connectors, Multimate Contacts, see Figure 3. Due to the large selection available for crimp type contacts and hand crimping tools, refer to instruction sheet 408-1379.

For contacts used in Series 2 connectors, size 20 DM and 20 DF Contacts, see Figure 4.

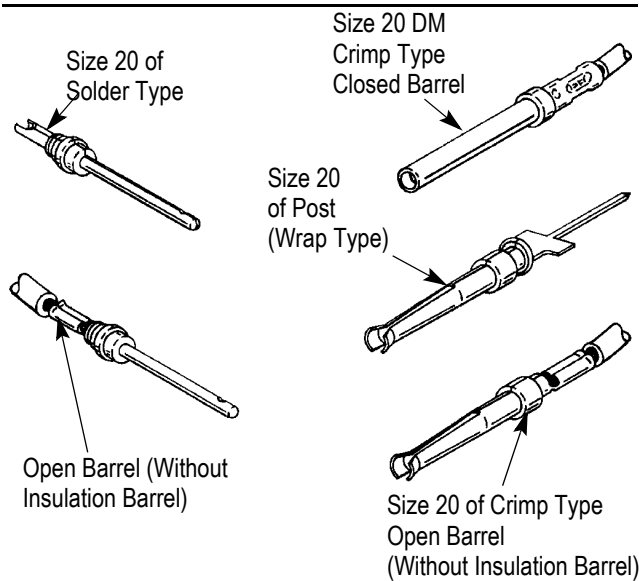

Figure 4

For contacts used in Series 3 connectors, Type XII Contacts, see Figure 5.

For contacts used in Series 4 connectors, Multimate and Type XII Contacts, see Figures 3 and 5.

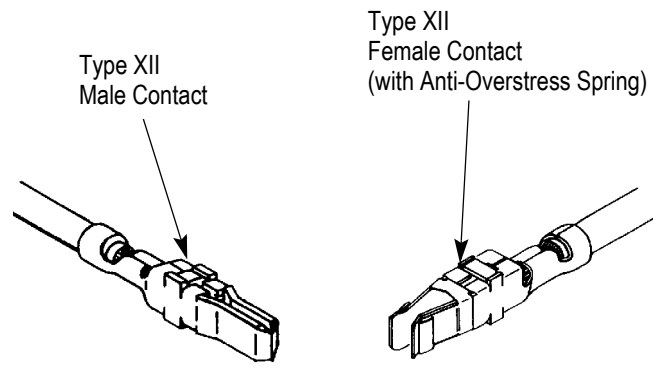

Figure 5

Recommendation - Socket contacts should be attached to wires leading to power source, and installed in housing that has flush mating surface. This procedure provides maximum protection for both the pin and the socket contact, and minimizes the possibility of electrical shock.

Crimping - Strip form contacts are designed to be crimped with a TE semi-automatic or automatic machine. Consult your local TE representative for assistance in selecting the machine that will best suit your needs.

Loose piece contacts are designed to be crimped with TE crimp tooling (hand tools, die assemblies, or crimping heads). The applicable crimp tooling for the contacts is listed on 408-1379. Read the material packaged with the crimp tooling for the proper crimping procedure.

Insertion - Normally, an insertion tool is not required to insert contacts into the housings. However, if the wire bundle is large, or if the wire is fragile, an insertion tool is recommended. Refer to 408-1379 for the appropriate insertion tool.

To insert a contact, grip insulation of wire (directly behind contact) and align contact with BACK of desired contact cavity. Insert contact straight into cavity until it bottoms. Pull back lightly on wire to be sure contact is locked in place. See Figure 6.

Extraction - TE extraction tools (refer to 408-1379) are designed for removing pin and socket contacts from the connectors. Refer to the instruction material packaged with the tool for the proper extraction procedure.

Release the contact from the FRONT of Series 1, 3, and 4 connectors, and from the BACK of series 2 connectors (See Figure 7).

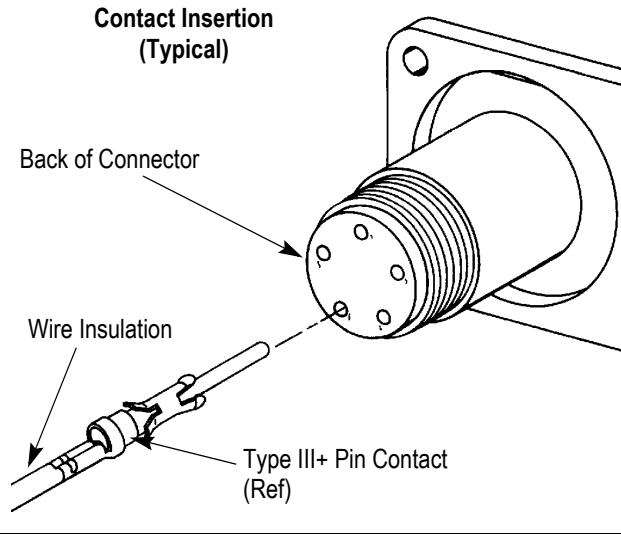

Figure 6

5. PANEL MOUNTING

The receptacle may be either FRONT or REAR panel mounted. When REAR mounted, the panel thickness must not exceed 3.18mm [1/8 in.], otherwise plug will bottom on panel before it is secure.

Determine size of connector to be mounted. Refer to the applicable dimensions provided in Figure 8 and make the panel cutout. Secure connector to panel using commercially available hardware (No. 4 screws).

Contact Insertion

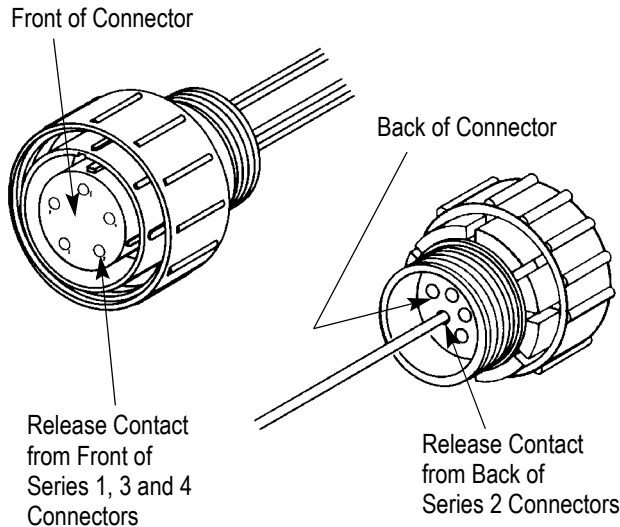
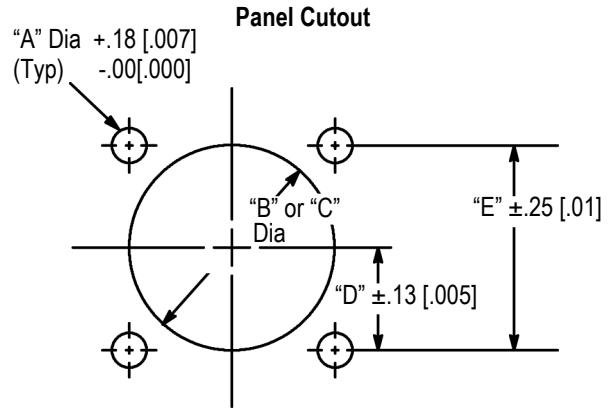

Figure 7

6. MATING CONNECTORS

These connectors have a positive lock feature which prevents accidental disengagement. Align polarizing keys and keyways and start plug into receptacle. Rotate coupling ring CLOCKWISE until positive lock snaps into position.



Connector Size	Dimensions				
	A	B (Front Mount)	C (Rear Mount)	D	E
14	3.18 [.125]	27.18 [1.070]	27.18 [1.070]	11.51 [.453]	23.01 [.906]
22	3.05 [.120]	29.36 [1.156]	39.34 [1.549]	15.88 [.625]	31.75 [1.250]
28	3.68 [.145]	40.89 [1.610]	50.04 [1.970]	19.84 [.781]	39.67 [1.562]

Figure 8

7. REVISION SUMMARY

Since the previous release of this document, the following has been changed:

- Updated document to corporate requirements
- Added dual dimensions
- Updated external document references