

Figure 1

1. INTRODUCTION

These low-profile 38999-style jam-nut receptacle connectors are designed to be installed onto 900-µm buffered optical fiber with a length less than 1 meter.

NOTE
 Dimensions in this instruction sheet are in metric units. Figures are not drawn to scale.

The connector must be assembled using a jam-nut receptacle connector shell kit, an EB insert assembly kit, and ferrule assembly kit (one for each fiber or channel). Sample part numbers are given in Figure 1. The combination of the kits selected is based on the mode and quantity of fibers, and the operating wavelength of the system.

CAUTION
 To avoid poor optical performance or permanent damage to the lens of the EB insert, use **ONLY** TE Connectivity ferrule assembly kits. Other manufacturers' ferrule assemblies **ARE NOT** compatible with the EB insert assembly kit.

Reasons for reissue of this instruction sheet are provided in Section 7, REVISION SUMMARY.

2. DESCRIPTION

Each kit contains the components shown in Figure 1.

The EB insert assembly kit is shipped with a white protective label on the back (end opposite the lens) of

the EB insert which is installed immediately after final testing to keep the channel cavities clean. The EB insert is ready for assembly as shipped.

3. HANDLING

DANGER
 To avoid personal injury, **NEVER** look into the end of terminated or unterminated optical fibers. Laser radiation is invisible but can damage eye tissue.

- Do not touch the lens of the EB insert with your fingers or with any tools

NOTE
 If the lens is touched or otherwise contaminated, clean the lens according to Instruction Sheet 408-8828.

- After assembly, re-install the protective cap or mate the connector immediately after the cap has been removed to prevent contamination to the EB insert assembly

4. TOOLS AND MATERIALS

The following tools and materials are necessary for preparation, assembly, inspection, and maintenance of the connector and cable assembly. Follow the operating instructions packaged with the tools and safety guidelines packaged with the materials.

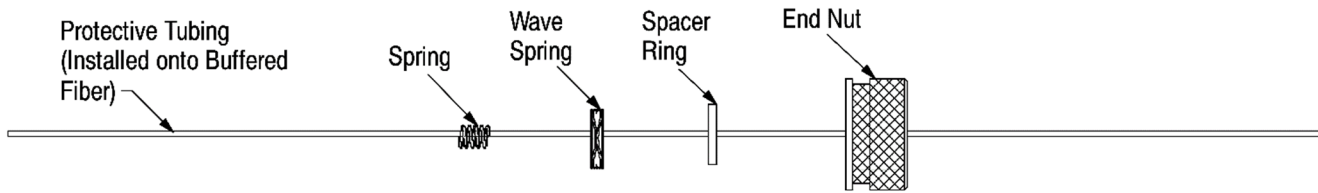

Figure 2

NOTE



Items without a part number or supplier are customer supplied.

4.1. Tools

- environmental test oven
- Heat Cure Oven Assembly 502134-1 (120 Vac) or -2 (240 Vac) includes universal heat cure block (408-9460)
- Fiber Stripping Tool 1278947-1 (408-4577)
- Fiber Jacket Stripper 1278531-1
- Curing Fixture 1754122-1 (408-8857)
- Sapphire Scribe Tool 504064-1 (408-4293)
- polishing machine (recommended) or Polishing Bushing 503337-1 (for hand polishing)
- 200x Microscope Kit 1754767-1
- Ferrule Insertion Tool 1693820-1
- 2-mm hex wrench
- keyed adapter tool with handle or bench-mount fixture, strap wrench or soft-jawed pliers, and torque wrench or torque stand†
- 27-mm jam-nut socket

4.2. Materials

- Buffer Protective Tubing 492667-1 (bulk reel)
- lint-free tissues or cloths
- isopropyl alcohol (99%) or acetone
- EPO-TEK 353ND-T epoxy
- Epoxy Applicator Kit 501473-3

For hand polishing only:

- 5- μ m Aluminum Oxide Polishing Film 228433-8
- 1mm Rubber Polishing Pad 501858-1 (green)
- 0.3- μ m Diamond Polishing Film 228433-5
- Final Polishing Film 502748-2
- lint-free applicator swabs
- Loctite 243 medium-strength threadlocker
- Dow Corning Molykote 55 O-ring grease

Loctite and 243 are trademarks of Henkel Corporation.

Dow Corning and Molykote are registered trademarks of Dow Corning Corporation.

†BETA backshell assembly tools from Daniels Manufacturing Corporation are recommended. For catalog, visit: https://files.dmctools.com/public/catalogues/beta_backshell_tooling_guide_o3Vr6l3.pdf

5. ASSEMBLY PROCEDURE

IMPORTANT: Assemble the connector using a laminar flow table in a clean environment meeting the requirements of International Organization for Standardization (ISO) 14644-1 (Class 5), “Cleanrooms and Associated Controlled Environments, Part 1.” Make sure that all components are free from contamination.

Proceed as follows:

NOTE



These instructions are for single-channel connectors. For multi-channel connectors, perform the same assembly procedure for each channel.

5.1. Prepare and Terminate the Fiber

1. If a protective tubing *is not installed* on the buffered fiber, proceed with the following:
 - a. Pre-heat the environmental test oven to a temperature between 100°C and 105°C.
 - b. Cut the protective tubing to a length of approximately 10% longer than the length of the buffered fiber.
 - c. Stress-relieve the protective tubing by placing it in the environmental test oven for 45 to 60 minutes.

CAUTION



The protective tubing must be stress-relieved; otherwise, it could shrink during application and cause the fiber to buckle.

- d. Slide the prepared protective tubing over the buffered fiber, allowing approximately 100 mm of the buffered fiber to be exposed.
- e. Pre-heat the heat cure oven to 100°C.
- f. Slide the components shown in Figure 2 over the buffered fiber and onto the protective tubing. Make sure to orient each component as shown.

g. Using the fiber stripping tool, strip the buffered fiber to the dimension shown in Figure 3, exposing the bare fiber. Using a lint-free tissue or cloth dampened with isopropyl alcohol or acetone, clean the bare fiber.

h. Prepare the ferrule assembly according to Paragraph 5.2.

i. Carefully insert the bare fiber into the back of the ferrule assembly. Simultaneously slide and rotate the ferrule assembly on the fiber (to prevent any air pockets from being trapped in the epoxy) until it bottoms. Make sure that the bare fiber is protruding from the end face of the ferrule assembly. If it is not, re-strip the fiber.

j. Apply a *thin film* of epoxy around the outside edge of the protective tubing to the width given in Figure 3.

k. Insert the protective tubing into the back of the ferrule assembly until the tubing bottoms.

l. Proceed to Step 3.

2. If a protective tubing *is installed* (and secured) to the buffered fiber, proceed with the following:



CAUTION MAKE SURE THAT THE PROTECTIVE TUBING IS STRESS-RELIEVED; otherwise, it could shrink during application and cause the fiber to buckle.

- a. Pre-heat the heat cure oven to 100°C.
- b. Slide the components shown in Figure 2 onto the protective tubing, allowing 23±1 mm at the end of the tubing for stripping. Make sure to orient each component as shown.
- c. Mark the protective tubing to the dimension shown in Figure 4. Using Slot 22 of the fiber jacket stripper, strip the tubing to the marking.
- d. Using the fiber stripping tool, strip the buffered fiber to the dimension shown in Figure 4, exposing the bare fiber. Using a lint-free tissue or cloth dampened with the isopropyl alcohol or acetone, clean the bare fiber.
- e. Prepare the ferrule assembly according to Paragraph 5.2.
- f. Apply a *thin film* of epoxy around the outside edge of the tubing to the width given in Figure 4.

If Protective Tubing is Not Installed

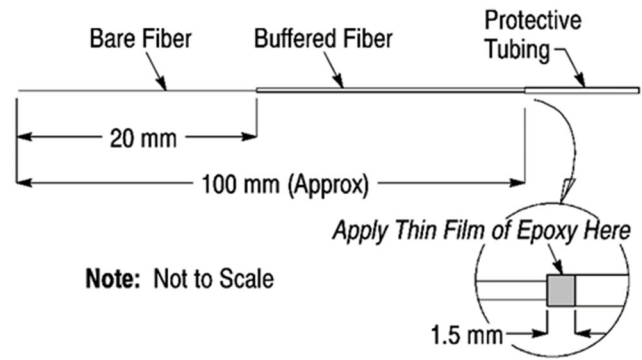

Note: Not to Scale

Figure 3

If Protective Tubing is Installed (and Secured)

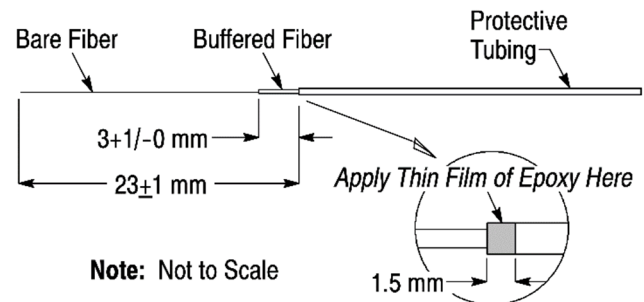

Note: Not to Scale

Figure 4

g. Carefully insert the bare fiber and protective tubing into the back of the ferrule assembly. Simultaneously slide and rotate the ferrule assembly on the fiber (to prevent any air pockets from being trapped in the epoxy) until it bottoms. Make sure that the tubing enters and adheres to the base. Make sure that the bare fiber is protruding from the end face of the ferrule assembly. If it is not, re-strip the fiber.

h. Proceed to Step 3.

3. Place the assembly in the curing fixture according to the instructions included with the curing fixture.

4. Cure the assembly in the heat cure oven at 100°C for 20 minutes. Remove the assembly from the oven, and allow the assembly to cool to room temperature.

5.2. Prepare the Ferrule Assembly

1. Prepare the epoxy according to the following:

- a. Remove the separating clip from the epoxy package. Mix the two components together thoroughly for 20 to 30 seconds.

- b. Install the needle tip on the applicator from the epoxy applicator kit. Make sure it is secure. Remove the plunger.
- c. Cut the epoxy packet open and squeeze the epoxy into the back of the applicator. Re-assemble the plunger. Hold the applicator vertically, and slowly push on the plunger until the entrapped air escapes and a bead of epoxy appears at the needle tip.
- d. Using a lint-free tissue or cloth dampened with the isopropyl alcohol or acetone, clean the tip of the applicator.

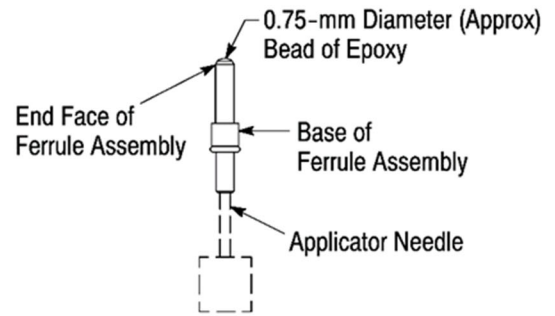

Figure 5

2. Hold the ferrule assembly vertically, and insert the needle tip into the base of the ferrule assembly until it is against the back (end closest to the base) of the ferrule assembly. Refer to Figure 5.
3. While holding the ferrule assembly *firmly* against the needle tip, *slowly* inject the epoxy until a small bead of epoxy (approximately 0.75 mm in diameter) forms at the end face of the ferrule assembly. DO NOT allow the bead to get too large or smear.
4. Withdraw the needle slightly (approximately 2 to 3 mm), and inject an additional small amount of epoxy so that the cavity at the base of the ferrule assembly is no more than one-third full.



Make sure the cavity is no more than one-third full. Excess epoxy at the base of the ferrule assembly will wick into the protective tubing and cause the fiber to break during use.



To avoid personal injury, remember that epoxy is a hazardous material, and pay particular attention to the following:

- ALWAYS follow manufacturer's safety guidelines.
- ALWAYS wear protective gloves when using epoxy.
- ALWAYS use epoxy in a well-ventilated area.
- AVOID prolonged and frequent contact with skin.
- AVOID inhaling fumes from epoxy.

5.3 Cleave the Fiber

Firmly support the ferrule assembly, and draw the beveled edge of the scribe tool across the fiber as shown in Figure 6. After scoring the fiber, pull the fiber straight away from the ferrule assembly.



Safely dispose of excess fiber.

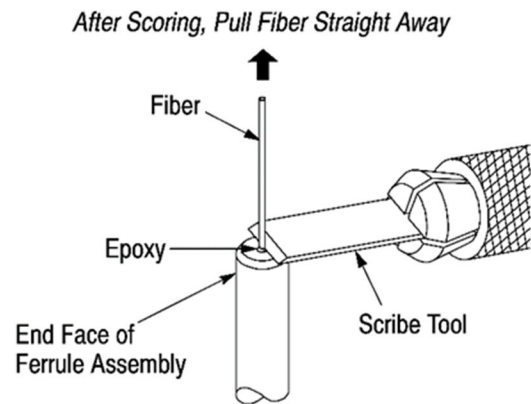

Figure 6



To avoid damage to the tip of the scribe tool, DO NOT allow the scribe tool to contact the epoxy.

5.4 Polish the Fiber

It is recommended polishing the fibers using a polishing machine. Machine polishing will usually produce the best results. Polish the fibers according to the machine manufacturer's instructions. For best performance, as a minimum the polish should be an SPC (super physical contact) end finish for multimode, and a UPC (ultra physical contact) end finish for singlemode.

If machine polishing is not possible, hand polish the fiber according to the following:

1. Using a small piece of the 5- μ m polishing film, remove the fiber stub to the level of the epoxy.

2. Install the ferrule assembly onto the polishing bushing.
3. Place the green polishing pad on a hard, flat surface. Place the 5- μ m polishing film on the polishing pad.
4. Hold the ferrule assembly and rest the tips of your index finger, middle finger, and thumb on the top of the polishing bushing. Starting with very light pressure, polish the tip of the fiber in a figure-8 pattern. Refer to Figure 7. Polish the fiber until the epoxy turns a very light yellow.

NOTE *DO NOT remove all the epoxy. As the epoxy gets lighter, check the tip of the fiber frequently.*

5. Clean the end face of the ferrule assembly and polishing bushing with isopropyl alcohol or acetone and a lint-free tissue.
6. Place the 0.3- μ m polishing film on the polishing pad. Polish in a figure-8 pattern. Stop polishing as soon as all the epoxy is removed.
7. Clean the end face of the ferrule assembly and polishing bushing with isopropyl alcohol or acetone and a lint-free tissue.
8. Place the final polishing film on the polishing pad. Apply several drops of water to an unused area of the film. Move the ferrule assembly in 20-mm circles on the water for 25 seconds.

NOTE *One sheet of final polishing film will be enough to polish 10 to 20 ferrule assemblies.*

9. Remove the ferrule assembly from the polishing bushing. Clean the end face and sides of the ferrule assembly with isopropyl alcohol or acetone and a lint-free tissue.

5.5. Inspect the Ferrule Assembly and Fiber

DANGER *Never inspect or look into the end of a fiber when optical power is applied to the fiber. The infrared light used, although it cannot be seen, can cause injury to the eyes.*

1. Using the microscope kit, inspect the ferrule assembly and fiber according to the following criteria (refer to Figure 8):
 - Make sure that any epoxy is removed from the ferrule assembly
 - Dirt may be mistaken for small pits. If dirt is evident on the ferrule assembly or fiber, clean with isopropyl alcohol or acetone and a lint-free tissue, then dry

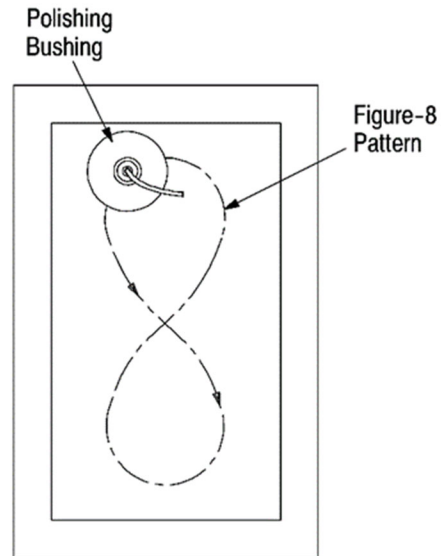

Figure 7

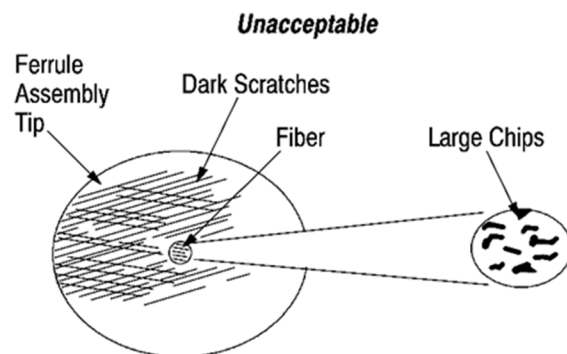
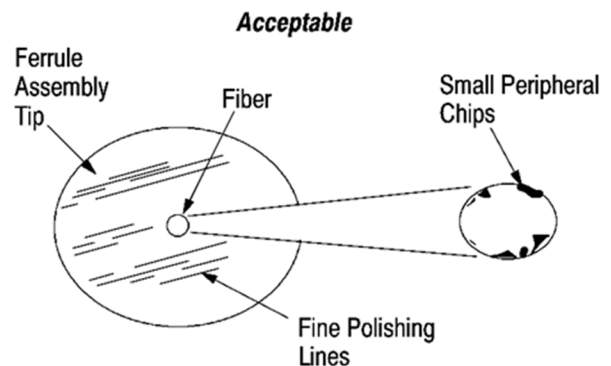

Figure 8

- Fine polishing lines are acceptable
- Small peripheral chips (at the outer rim) on the fiber are acceptable
- Large chips in the center of the fiber and dark scratches are unacceptable, and the fiber must be re-terminated

2. If necessary, install the dust cover onto ferrule assembly to prevent contamination to the end face.

5.6. Complete the Assembly

1. Remove the protective label from the back (end opposite the lens) of the EB insert.
2. Align the end of the ferrule assembly with the appropriate channel cavity of the EB insert and insert the ferrule assembly into the channel cavity until the o-ring is against the back of the insert. See Figure 9, Detail A. To avoid damage to the fiber, DO NOT push on the fiber to install the ferrule assembly.
3. Slide the spring over the fiber until it is against the O-ring of the ferrule assembly. See Figure 9, Detail B.
4. Using the ferrule insertion tool, **push on the spring** until the ferrule assembly bottoms in the channel cavity (the spring will protrude slightly from the cavity). See Figure 9, Detail C.

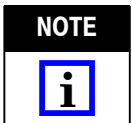

If necessary, to remove the ferrule assembly from the channel cavity, firmly grasp the end of the ferrule assembly (but not the spring) with the needle-nose pliers, and pull it out of the cavity.

5. Align the index pin hole of the ferrule plate with the index pin at the back of the EB insert, and slip the fiber into the closest slotted hole in the ferrule plate. See Figure 9, Detail D.

6. Hold the ferrule plate against the EB insert, making sure that the index pin enters the index hole. Thread the screw through the screw hole in the ferrule plate and into the hole in the EB insert. See Figure 9, Detail E. Using the 2-mm hex wrench and torque wrench or torque stand, tighten the screw to a torque between 0.8 and 1 N·m. Check to make sure that the ferrule plate is flush with the EB insert.

7. Using an applicator swab, apply a *thin film* of the grease around the O-ring of the EB insert. Refer to Figure 9, Detail F.



To avoid contaminating optical components, DO NOT use heavy deposits of the grease.

Detail A

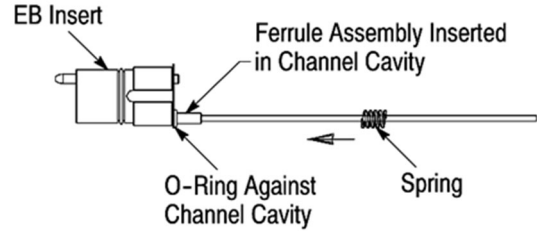

Detail B

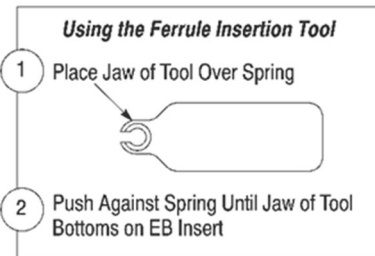
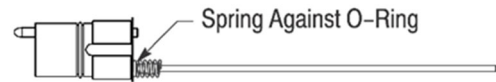

Detail C

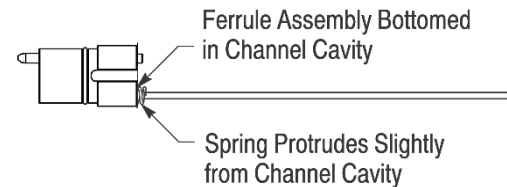

Detail D

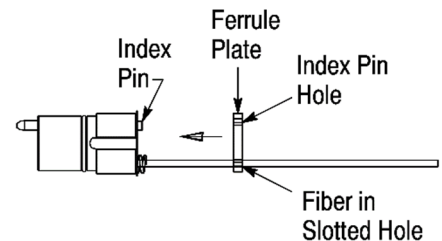

Detail E

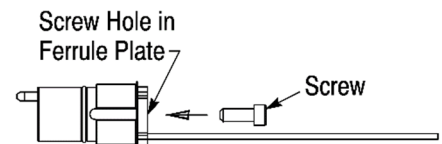

Detail F

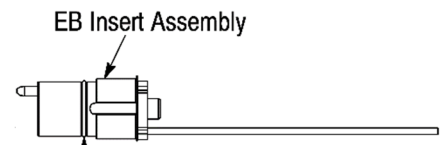

Apply Thin Film of Grease Here
O-Ring of EB Insert

Figure 9

8. Mount the housing onto the keyed adapter tool or bench-mount fixture. Align the internal key (small bar inside) of the housing with the keyway (slot along the side) of the EB insert, and slide the EB insert partially into the housing. See Figure 10, Detail A.

9. Using the 2-mm hex wrench, push the EB insert assembly into the housing until it bottoms (there will be a tactile “click” as the O-ring of the EB insert compresses and the insert assembly seats into place in the housing).

To avoid damage to the fiber, DO NOT push on the fiber or cable to install the EB insert assembly.

10. Slide the wave spring and spacer ring into the housing. See Figure 10, Detail B.

11. Apply several drops of the threadlocker to the threads at the back of the flange of the housing. See Figure 10, Detail C.

12. Thread the end nut onto the housing. See Figure 10, Detail C. Using the strap wrench or soft-jawed pliers and torque wrench or torque stand, tighten the end nut to a torque between 5 and 6 N·m.

13. Remove the housing from the keyed adapter tool or bench-mount fixture.

Detail A

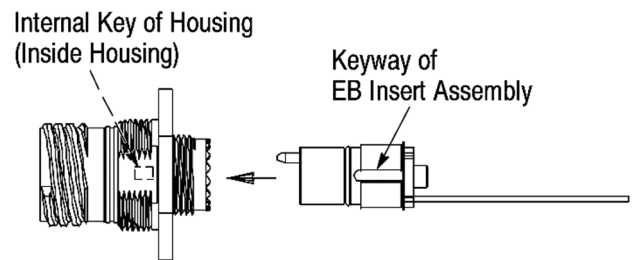

Detail B

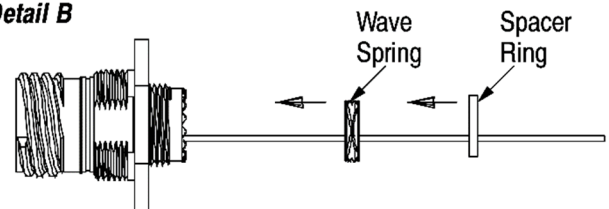

Detail C

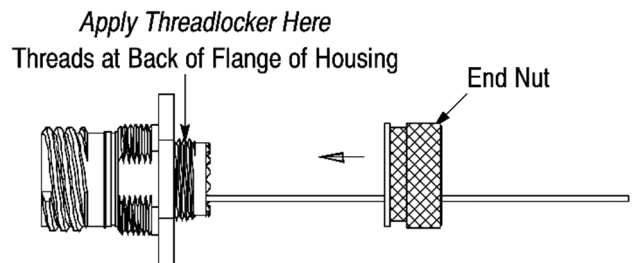

Figure 10

5.7. Mount the Connector onto the Panel and Install the Protective Cap

1. Cut the panel using the dimensions provided in Figure 11.

NOTE



Make sure that the flat edge is located in position to match the established rotational orientation.

Panel Thickness Range 1.58–3.2 mm

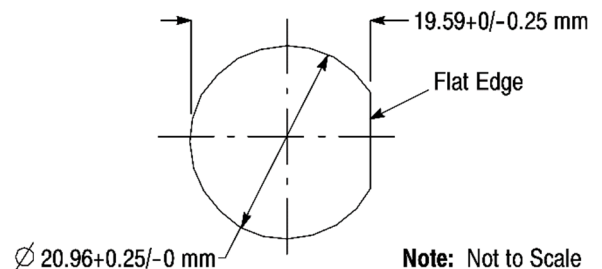

Figure 11

2. Make sure that the flange O-ring is installed in the groove of the housing flange (refer to Figure 1). Then, install the connector through the back of the panel so that the O-ring on the shoulder of the housing is flat against the panel. See Figure 12, Detail A.

3. Slide the loop of the tether of the protective cover over the threads at the front of the flange of the housing. See Figure 12, Detail A.

4. Thread the jam nut onto the housing. See Figure 11, Detail A. Using the jam-nut socket and torque wrench, tighten the jam nut to a torque between 4.5 to 5.2 N·m (40 to 46 in·lb.). The O-ring should now be compressed.

5. Thread the protective cap onto the housing. Hand-tighten the protective cap. See Figure 12, Detail B.

6. REPLACEMENT AND REPAIR

Kit components are not repairable. DO NOT use any damaged or defective components. DO NOT attempt to re-use the crimp support, crimp sleeve, or ferrule assembly by removing the fiber.

Order replacement parts through your TE Connectivity representative, or call 1-800-522-6752, or use the LIVE CHAT on the www.te.com website.

7. REVISION SUMMARY

Revisions to this instruction sheet include:

- Updated document to current corporate requirements
- Section 4.1: updated fiber stripping tool and polishing bushing p/n's, removed epoxy p/n and replaced with recommended epoxy type, removed polishing plate, added ferrule insertion tool
- Section 5.4: revised singlemode/multimode polish requirements and Steps 3, 6, and 8
- Revised and added to the Detail illustrations in Figure 9 to add the use of the ferrule insertion tool for ferrule installation in Section 5.6. Steps 1 through 4.

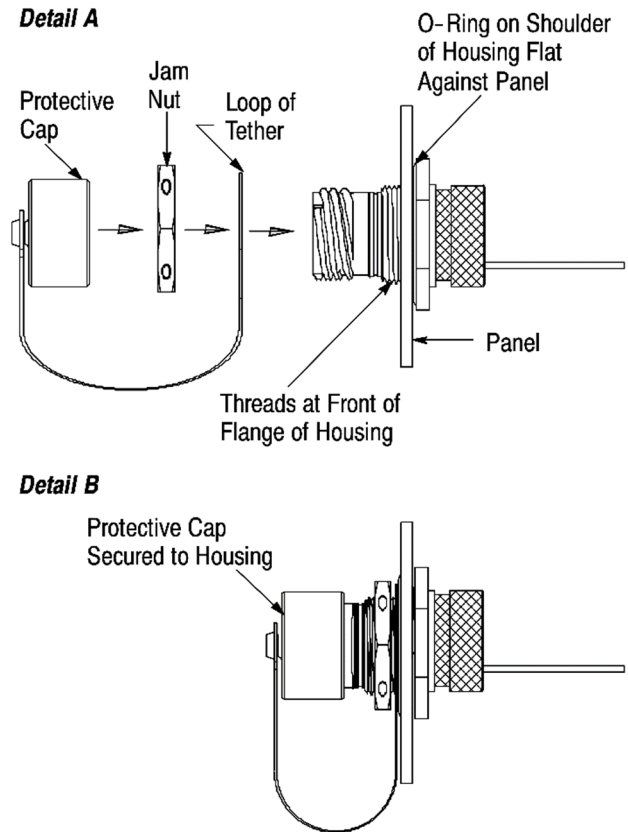

Figure 12