

THIS DRAWING IS UNPUBLISHED. RELEASED FOR PUBLICATION 2002
 © COPYRIGHT 2002 BY TYCO ELECTRONICS CORPORATION. ALL RIGHTS RESERVED.

POSITION OPEN CAVITIES
(POSIZIONE CAVITA' APERTE)
 8, 9, 17, 25, 28, 30, 31, 38,
 42, 45, 46, 48, 52, 54, 56, 57,
 58, 61, 62, 68, 69, 70, 71, 72,
 75, 77, 78, 80, 90, 91, 92, 93.

POSITION CLOSED CAVITIES
(POSIZIONE CAVITA' CHIUSE)
 7, 10, 11, 12, 13, 14, 15, 16, 18,
 19, 20, 21, 22, 23, 24, 26, 27, 29,
 32, 33, 34, 35, 36, 37, 39, 40, 41,
 43, 44, 47, 49, 50, 51, 53, 55, 59,
 60, 63, 64, 65, 66, 67, 73, 74, 76,
 79, 81, 82, 83, 84, 85, 86, 87, 88,
 89, 94.

LOC		DIST		REVISIONS			
P	LTR	DESCRIPTION	DATE	DWN	APVD		
B33		REVISED PER ECO-19-000969	16JAN2019	AP	VN		
B34		REVISED PER ECO-20-003218	05JUN2020	AP	VN		
B35		REVISED PER ECO-20-013820	30SEP2020	AP	VN		
B36		REVISED PER ECN-22-159897	21JUN2022	V. N.	V. N.		

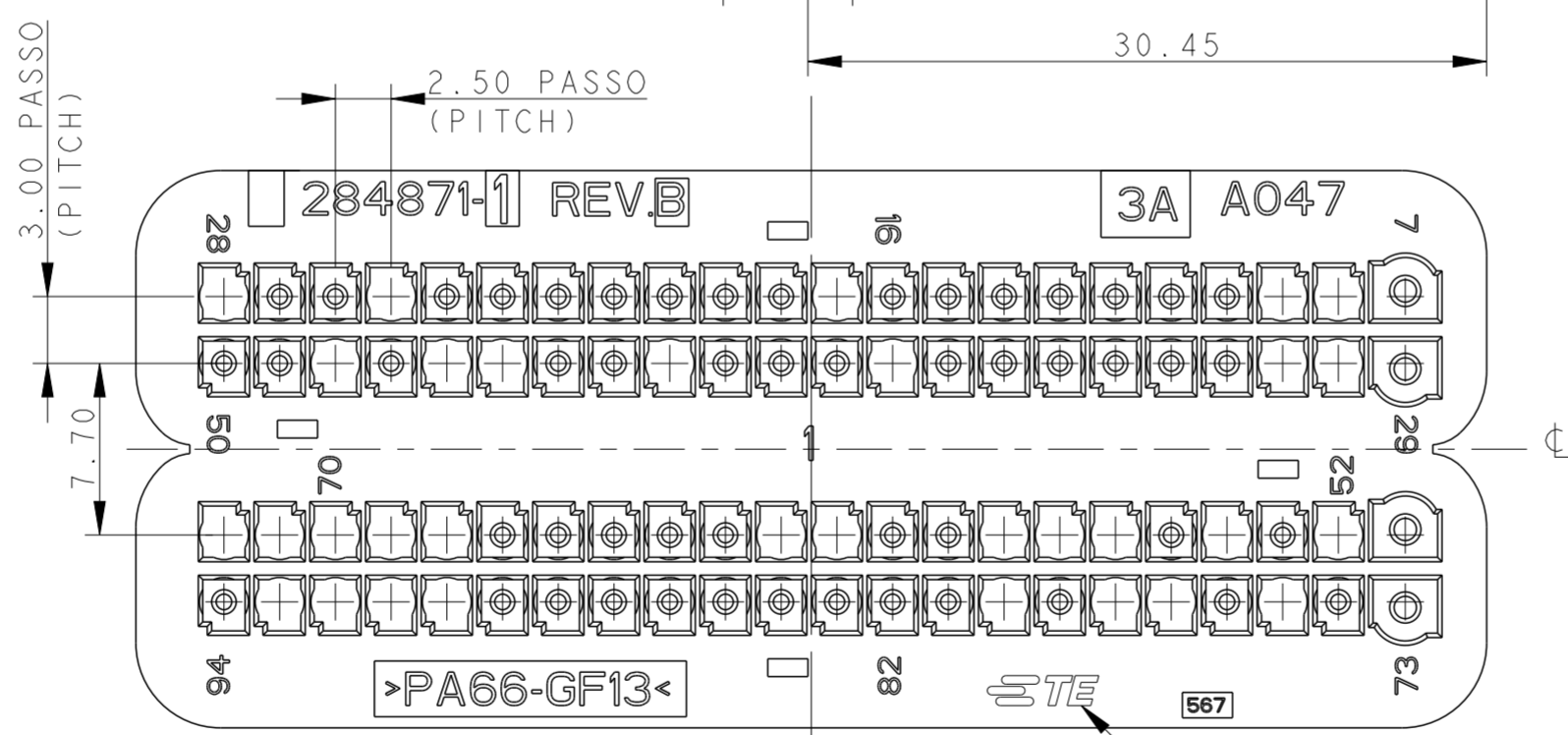
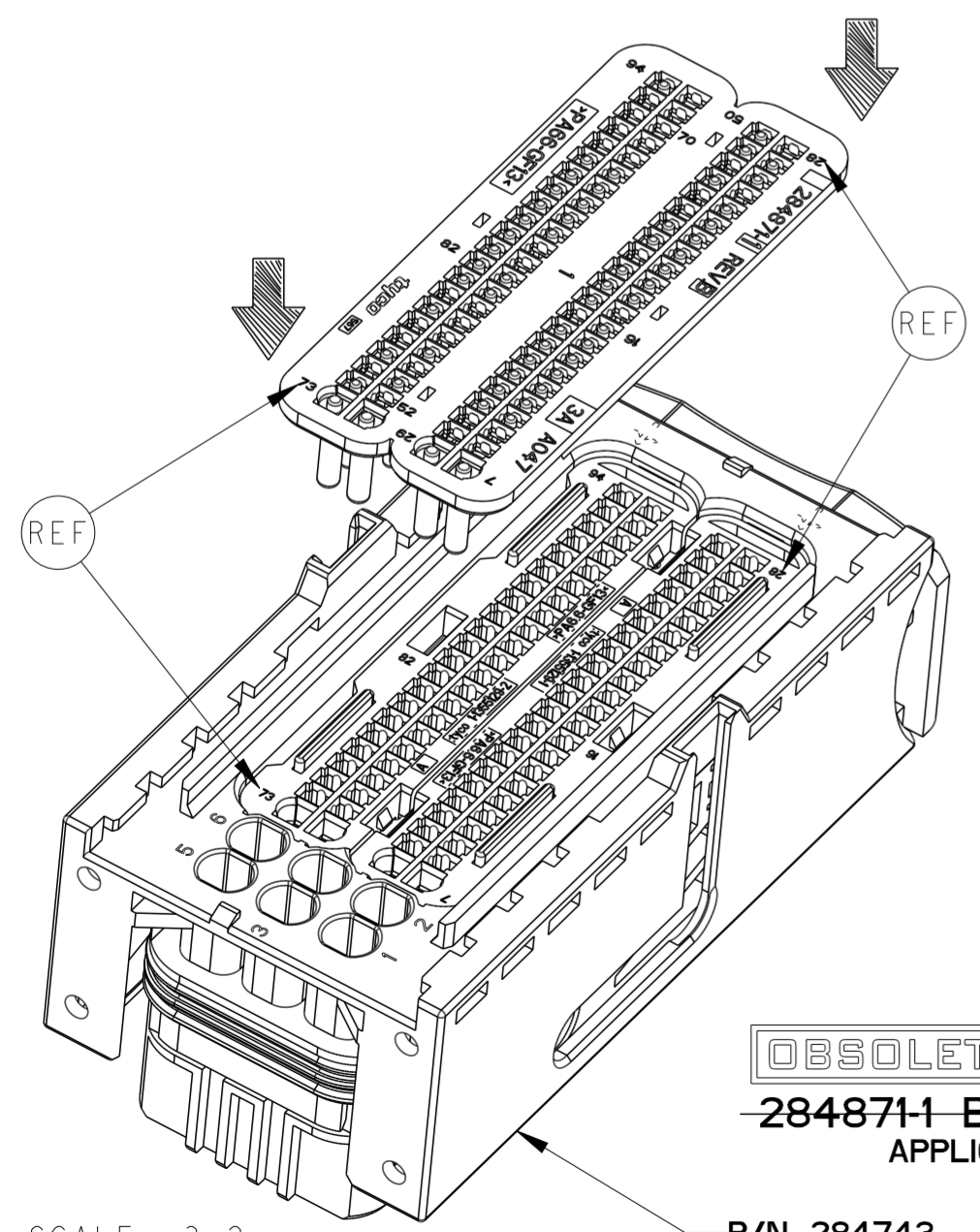
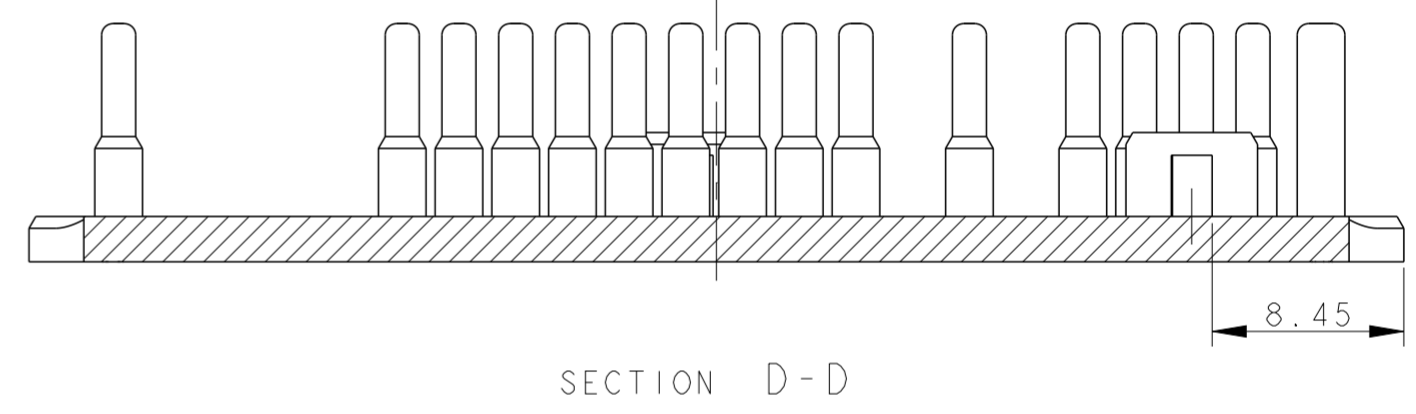
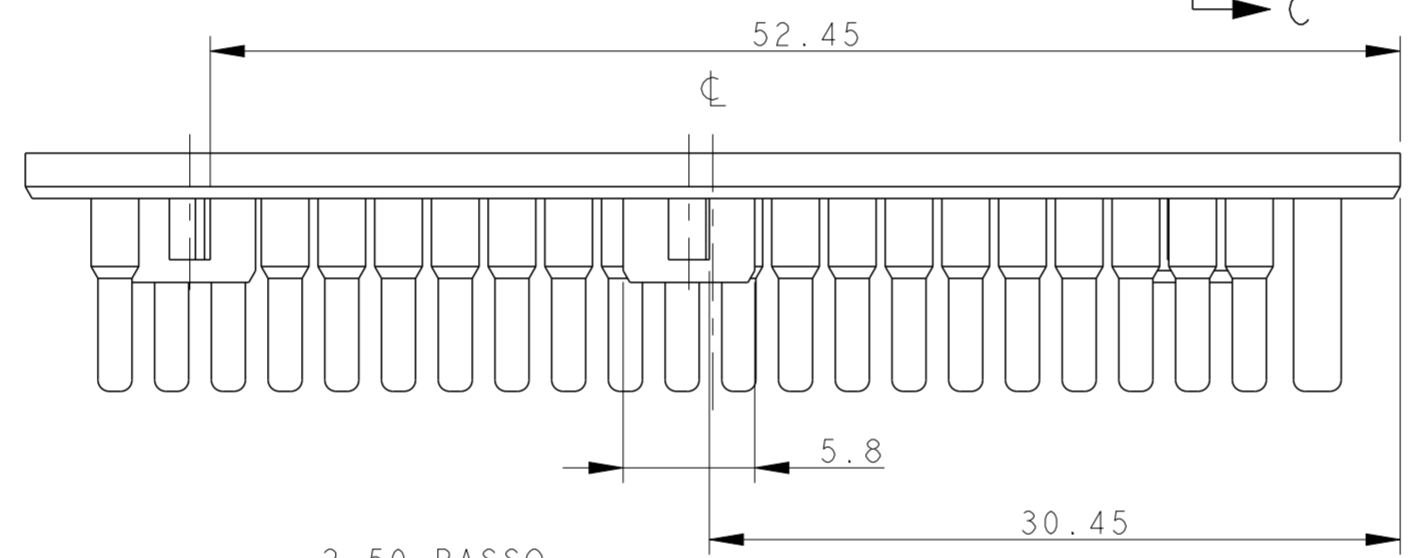
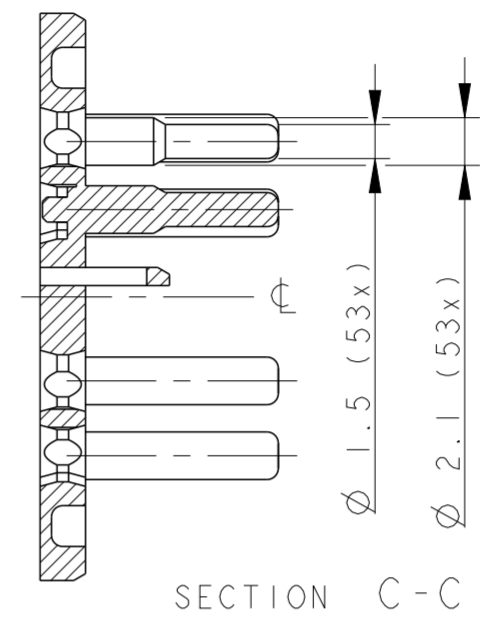
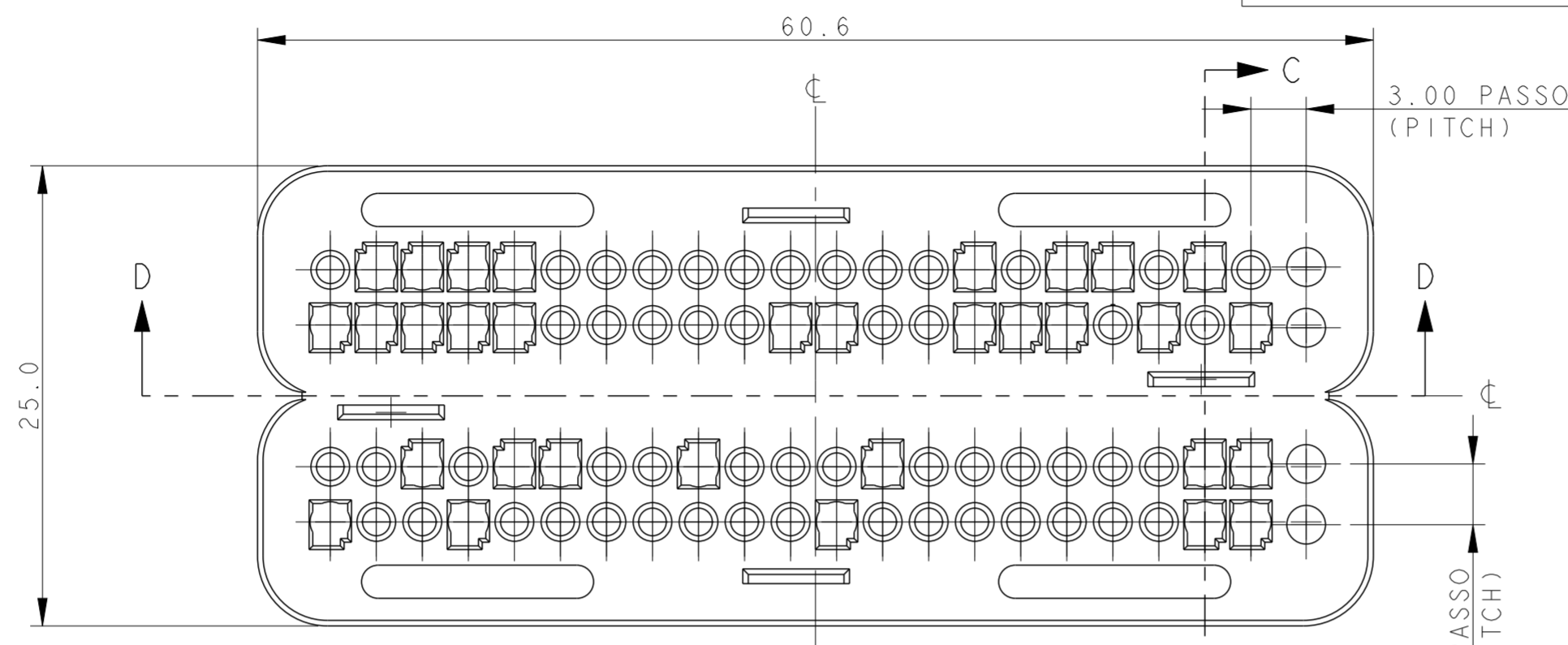
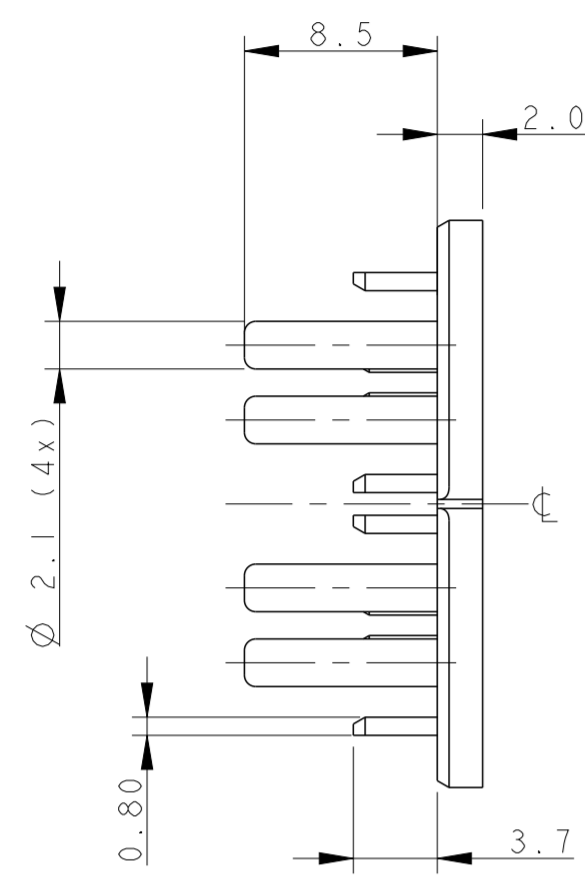

- ASSEMBLY OPERATIONS (REF. I.S. 411-20067):
OPERAZIONI DI ASSEMBLAGGIO (VEDERE I.S. 411-20067):
PLACE THE CAVITY MASK IN ORDER TO HAVE THE RIGHT CORRESPONDENCE BETWEEN ITS CAVITY NUMBER AND THE ONE PRINTED ON THE SEALING HOLDER (SEE "REF" INDICATION)
POSIZIONARE IL COPERCHIO TAPPA CAVITA' IN MODO DA FAR CORRISPONDERE IL NUMERO DI CAVITA' CON LO STESSO NUMERO PRESENTE SUL COPERCHIO GUARNIZIONE (VEDI L'INDICAZIONE "REF")
- PUSH THE CAVITY MASK UNTIL THE FOUR LANCES FIRMLY LOCK
SPINGERE IL COPERCHIO TAPPA CAVITA' FINO AD AGGANCIARE LE QUATTRO LANCETTE DI RITENZIONE

NOTES
 1) POLYAMIDE 6.6 GLASS FILLED BLACK COLOUR)
 PA 66 CARICATO VETRO COLORE NERO
 2) THE CAVITY MASKS MUST BE ASSEMBLED ON CONNECTOR P/N 284743-1/-2
 I COPERCHI TAPPA CAVITA' VANNO ASSEMBLATI CON IL PORTA CONTATTI COMPLETO P/N 284743-1/-2
 3) TE CONNECTIVITY LOGO IN ALTERNATIVE LOGO OR LOGO (MARCHIO TE CONNECTIVITY IN ALTERNATIVA MARCHIO OPPURE)

OBSOLETE
 284871-1 BLACK AS SHOWN
 APPLICATION : IVECO
 P/N 284743

SCALE 3:2

DIMENSIONS: mm		TOLERANCES UNLESS OTHERWISE SPECIFIED:		DWN 05DEC2002	TE Connectivity	NAME		
MATERIAL		FINISH		CHK 05DEC2002		CAVITY MASK FOR 94 POS. CONNECTOR (COPERCHIO CAVITA' PER CONNETTORE 94 POSIZIONI)		
APVD		PRODUCT SPEC		APVD 05DEC2002		SIZE	CAGE CODE	DRAWING NO
MATERIAL		FINISH		108-20254		A2	00779	C-284871
CUSTOMER DRAWING				411-20067	WEIGHT	RESTRICTED TO		
				-	SCALE 3:1		SHEET 1 OF 11	
						REV B36		

LOC	DIST	REVISIONS			
P	LTR	DESCRIPTION	DATE	DWN	APVD
-	-	SEE SHEET 1	-	-	-

OBSOLETE P/N 284871-2 GREY AS SHOWN

△ POLYAMIDE 6.6 GLASS FILLED GREY COLOUR
PA 66 CARICATO VETRO COLORE GRIGIO

POSITION OPEN CAVITIES (POSIZIONE CAVITA' APERTE)	POSITION CLOSED CAVITIES (POSIZIONE CAVITA' CHIUSE)
8, 9, 10, 11, 12, 13, 17, 22, 25, 28, 29, 30, 31, 38, 45, 46, 47, 51, 52, 54, 56, 61, 62, 64, 65, 68, 69, 71, 72, 74, 77, 78, 79, 80, 83, 84, 86, 87, 90, 91, 93	7, 14, 15, 16, 18, 19, 20, 21, 23, 24, 26, 27, 32, 33, 34, 35, 36, 37, 39, 40, 41, 42, 43, 44, 48, 49, 50, 53, 55, 57, 58, 59, 60, 63, 66, 67, 70, 73, 75, 76, 81, 82, 85, 88, 89, 92, 94

P/N 284871-3 BROWN AS SHOWN

△ POLYAMIDE 6.6 GLASS FILLED BROWN COLOUR
PA 66 CARICATO VETRO COLORE MARRONE

POSITION OPEN CAVITIES (POSIZIONE CAVITA' APERTE)	POSITION CLOSED CAVITIES (POSIZIONE CAVITA' CHIUSE)
7, 8, 10, 13, 15, 23, 28, 29, 32, 35, 37, 40, 41, 50, 58, 59, 61, 64, 65, 66, 68, 70, 74, 75, 76, 78, 79, 80, 83, 87, 88, 90, 92, 93	9, 11, 12, 14, 16, 17, 18, 19, 20, 21, 22, 24, 25, 26, 27, 30, 31, 33, 34, 36, 38, 39, 42, 43, 44, 45, 46, 47, 48, 49, 51, 52, 53, 54, 55, 56, 57, 60, 62, 63, 67, 69, 71, 72, 73, 77, 81, 82, 84, 85, 86, 89, 91, 94

OBSOLETE P/N 284871-4 GREEN AS SHOWN

△ POLYAMIDE 6.6 GLASS FILLED GREEN COLOUR
PA 66 CARICATO VETRO COLORE VERDE

POSITION OPEN CAVITIES (POSIZIONE CAVITA' APERTE)	POSITION CLOSED CAVITIES (POSIZIONE CAVITA' CHIUSE)
7, 8, 13, 15, 23, 26, 27, 28, 32, 35, 41, 50, 58, 59, 61, 65, 68, 70, 74, 75, 76, 79, 80, 83, 88, 90, 92, 93	9, 10, 11, 12, 14, 16, 17, 18, 19, 20, 21, 22, 24, 25, 29, 30, 31, 33, 34, 36, 37, 38, 39, 40, 42, 43, 44, 45, 46, 47, 48, 49, 51, 52, 53, 54, 55, 56, 57, 60, 62, 63, 64, 66, 67, 69, 71, 72, 73, 77, 78, 81, 82, 84, 85, 86, 87, 89, 91, 94

OBSOLETE P/N 284871-5 BLUE AS SHOWN

△ POLYAMIDE 6.6 GLASS FILLED BLUE COLOUR
PA 66 CARICATO VETRO COLORE BLU

POSITION OPEN CAVITIES (POSIZIONE CAVITA' APERTE)	POSITION CLOSED CAVITIES (POSIZIONE CAVITA' CHIUSE)
7, 8, 10, 13, 15, 18, 19, 20, 21, 22, 23, 28, 29, 32, 35, 37, 40, 41, 50, 61, 64, 65, 66, 68, 70, 74, 75, 76, 78, 79, 80, 83, 86, 87, 88, 90, 92, 93	9, 11, 12, 14, 16, 17, 24, 25, 26, 27, 30, 31, 33, 34, 36, 38, 39, 42, 43, 44, 45, 46, 47, 48, 49, 51, 52, 53, 54, 55, 56, 57, 58, 59, 60, 62, 63, 67, 69, 71, 72, 73, 77, 81, 82, 84, 85, 89, 91, 94

P/N 284871-6 BLACK AS SHOWN

△ POLYAMIDE 6.6 GLASS FILLED BLACK COLOUR
PA 66 CARICATO VETRO COLORE NERO

POSITION OPEN CAVITIES (POSIZIONE CAVITA' APERTE)	POSITION CLOSED CAVITIES (POSIZIONE CAVITA' CHIUSE)
7, 8, 10, 11, 12, 13, 14, 15, 22, 23, 26, 30, 32, 33, 35, 37, 40, 41, 44, 45, 46, 47, 49, 50, 61, 64, 65, 70, 71, 73, 74, 76, 78, 79, 80, 81, 83, 85, 87, 89, 90, 91, 94	9, 16, 17, 18, 19, 20, 21, 24, 25, 27, 28, 29, 31, 34, 36, 38, 39, 42, 43, 48, 51, 52, 53, 54, 55, 56, 57, 58, 59, 60, 62, 63, 66, 67, 68, 69, 72, 75, 77, 82, 84, 86, 88, 92, 93

P/N 284871-9 GREEN AS SHOWN

△ POLYAMIDE 6.6 GLASS FILLED GREEN COLOUR
PA 66 CARICATO VETRO COLORE VERDE

POSITION OPEN CAVITIES (POSIZIONE CAVITA' APERTE)	POSITION CLOSED CAVITIES (POSIZIONE CAVITA' CHIUSE)
7, 8, 9, 10, 11, 12, 13, 17, 19, 20, 22, 28, 29, 30, 31, 32, 33, 34, 35, 36, 37, 40, 44, 45, 46, 51, 52, 55, 57, 64, 65, 68, 69, 71, 72, 74, 83, 84, 86, 87, 90, 93, 94	14, 15, 16, 18, 21, 23, 24, 25, 26, 27, 38, 39, 41, 42, 43, 47, 48, 49, 50, 53, 54, 56, 58, 59, 60, 61, 62, 63, 66, 67, 70, 73, 75, 76, 77, 78, 79, 80, 81, 82, 85, 88, 89, 91, 92

CAVITY MASK APPLICATIONS (APPLICAZIONE COPERCHIO CAVITA')						
P/N	284871-2	284871-3	284871-4	284871-5	284871-6	284871-9
APPLICATION (APPLICAZIONE)	350 8v F4 192 F3 E0BD 188 FL N.KAPPA 843	169 188	178 223 1.3 JTD 223 70 HP	350 848 843 1.3 JTD 843 70 HP	199 1.3 sde Marelli 16v 75/90cv sonda lambda riscaldato condizionato trappola particolato	199 1.9 JTD Bosch 8v condizionato

THIS DRAWING IS A CONTROLLED DOCUMENT FOR TYCO ELECTRONICS CORPORATION. IT IS SUBJECT TO CHANGE AND THE CONTROLLING ENGINEERING ORGANIZATION SHOULD BE CONTACTED FOR THE LATEST REVISION.

DIMENSIONS: mm

TOLERANCES UNLESS OTHERWISE SPECIFIED:
 0 PLC ±0.3
 1 PLC ±0.3
 2 PLC ±0.2
 3 PLC ±
 4 PLC ±
 ANGLES ±°
 FINISH

MATERIAL

DWN: M. POLIZZI 05DEC2002
 CHK: O. CANUTO 05DEC2002
 APVD: A. GENIA 05DEC2002

PRODUCT SPEC: 108-20254
 APPLICATION SPEC: 411-20067
 WEIGHT: -
 CUSTOMER DRAWING

NAME: CAVITY MASK FOR 94 POS. CONNECTOR (COPERCHIO CAVITA' PER CONNETTORE 94 POSIZIONI)

SIZE: A2 CAGE CODE: 00779 DRAWING NO: C-284871 RESTRICTED TO: -

SCALE: 3:1 SHEET: 2 OF 11 REV: B36

LOC		DIST		REVISIONS			
P	LTR	DESCRIPTION	DATE	DWN	APVD		
-	-	SEE SHEET 1	-	-	-		

P/N 1-284871-0 BLUE AS SHOWN

△ POLYAMIDE 6.6 GLASS FILLED BLUE COLOUR
 PA 66 CARICATO VETRO COLORE BLU

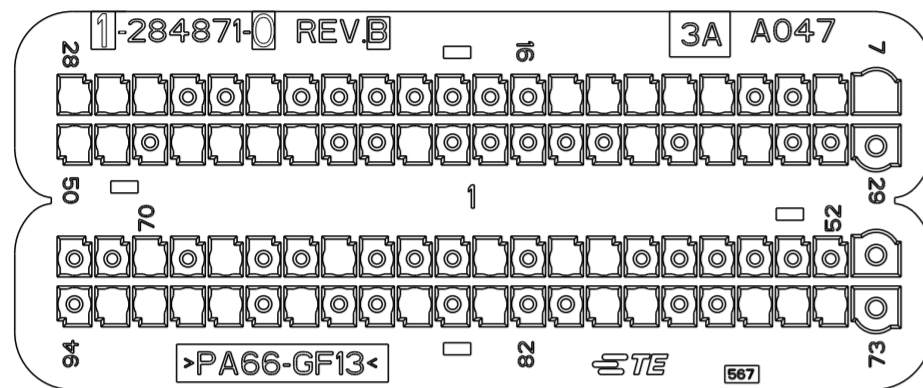

P/N 1-284871-1 BLACK AS SHOWN

△ POLYAMIDE 6.6 GLASS FILLED BLACK COLOUR
 PA 66 CARICATO VETRO COLORE NERO

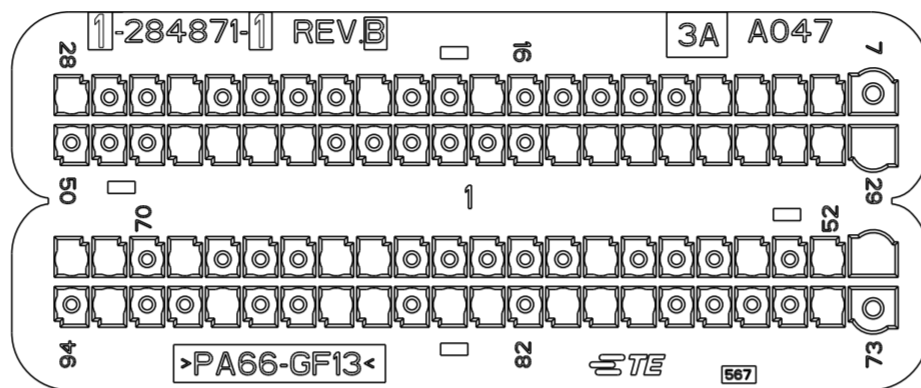

P/N 1-284871-2 GREY AS SHOWN

△ POLYAMIDE 6.6 GLASS FILLED GREY COLOUR
 PA 66 CARICATO VETRO COLORE GRIGIO

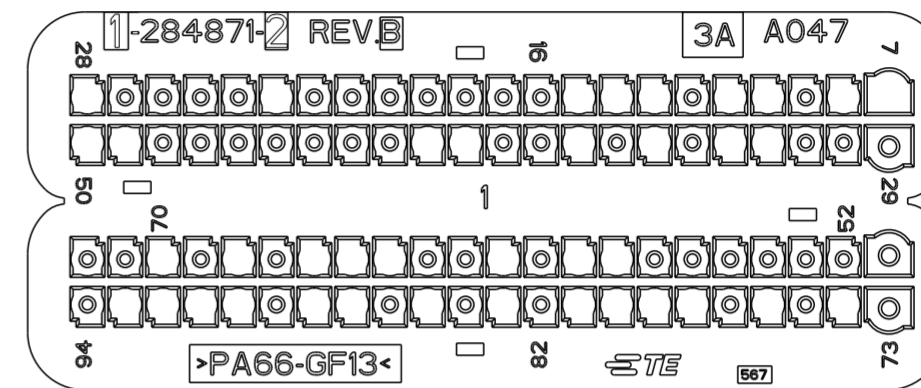

POSITION OPEN CAVITIES (POSIZIONE CAVITA' APERTE)	POSITION CLOSED CAVITIES (POSIZIONE CAVITA' CHIUSE)
7, 8, 11, 12, 13, 14, 15, 23, 26, 27, 28, 32, 33, 35, 41, 44, 45, 46, 47, 49, 50, 58, 59, 61, 65, 68, 70, 74, 75, 76, 79, 80, 83, 85, 88, 90, 91, 92, 93	9, 10, 16, 17, 18, 19, 20, 21, 22, 24, 25, 29, 30, 31, 34, 36, 37, 38, 39, 40, 42, 43, 48, 51, 52, 53, 54, 55, 56, 57, 60, 62, 63, 64, 66, 67, 69, 71, 72, 73, 77, 78, 81, 82, 84, 86, 87, 89, 94

POSITION OPEN CAVITIES (POSIZIONE CAVITA' APERTE)	POSITION CLOSED CAVITIES (POSIZIONE CAVITA' CHIUSE)
8, 9, 10, 11, 17, 20, 25, 28, 29, 30, 31, 32, 33, 34, 35, 36, 37, 44, 45, 46, 47, 51, 52, 54, 58, 64, 65, 69, 71, 72, 74, 79, 80, 81, 83, 84, 86, 87, 90, 93	7, 12, 13, 14, 15, 16, 18, 19, 21, 22, 23, 24, 26, 27, 38, 39, 40, 41, 42, 43, 48, 49, 50, 53, 55, 56, 57, 59, 60, 61, 62, 63, 66, 67, 68, 70, 73, 75, 76, 77, 78, 82, 85, 88, 89, 91, 92, 94

POSITION OPEN CAVITIES (POSIZIONE CAVITA' APERTE)	POSITION CLOSED CAVITIES (POSIZIONE CAVITA' CHIUSE)
7, 8, 10, 11, 13, 14, 15, 23, 28, 32, 33, 35, 37, 40, 41, 49, 50, 58, 59, 61, 64, 65, 66, 68, 70, 74, 76, 78, 79, 80, 81, 83, 85, 87, 88, 90, 91, 92, 93	9, 12, 16, 17, 18, 19, 20, 21, 22, 24, 25, 26, 27, 29, 30, 31, 34, 36, 38, 39, 42, 43, 44, 45, 46, 47, 48, 51, 52, 53, 54, 55, 56, 57, 60, 62, 63, 67, 69, 71, 72, 73, 75, 77, 82, 84, 86, 89, 94

P/N 1-284871-3 BROWN AS SHOWN

△ POLYAMIDE 6.6 GLASS FILLED BROWN COLOUR
 PA 66 CARICATO VETRO COLORE MARRONE

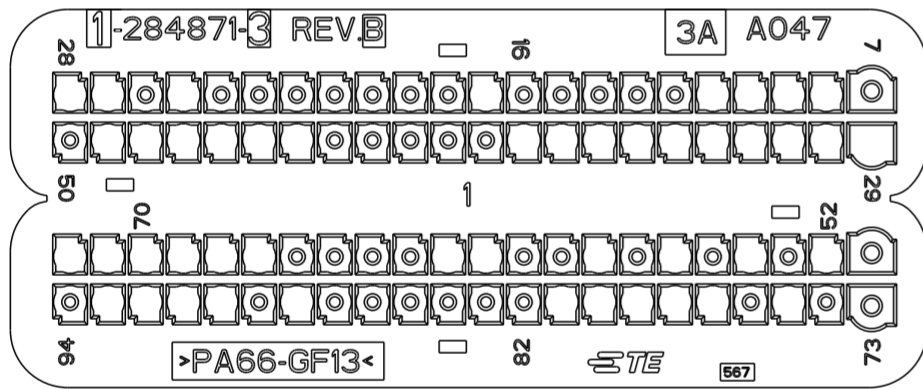

P/N 1-284871-4 GREEN AS SHOWN

△ POLYAMIDE 6.6 GLASS FILLED GREEN COLOUR
 PA 66 CARICATO VETRO COLORE VERDE

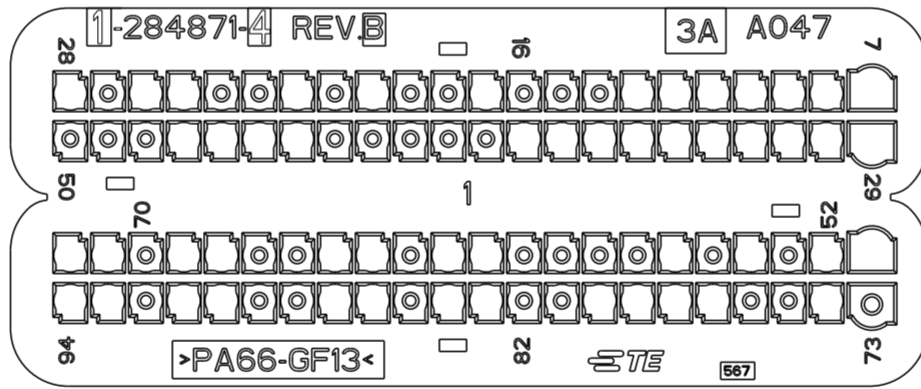

P/N 1-284871-5 BLUE AS SHOWN

△ POLYAMIDE 6.6 GLASS FILLED BLUE COLOUR
 PA 66 CARICATO VETRO COLORE BLU

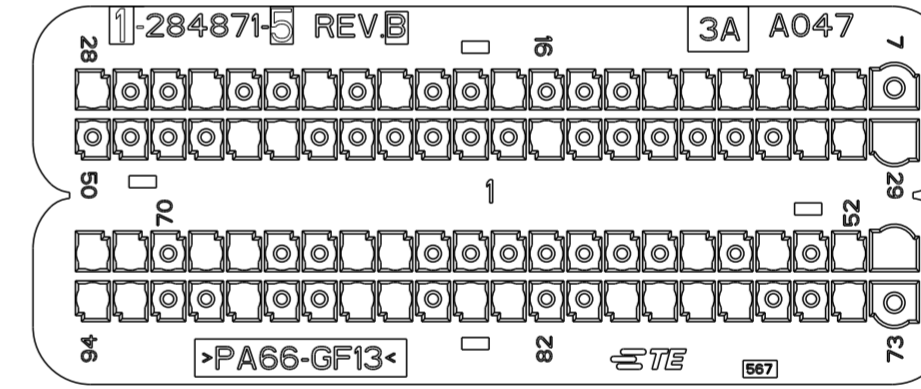

POSITION OPEN CAVITIES (POSIZIONE CAVITA' APERTE)	POSITION CLOSED CAVITIES (POSIZIONE CAVITA' CHIUSE)
8, 9, 10, 11, 17, 25, 27, 28, 29, 30, 31, 32, 33, 34, 35, 36, 37, 38, 44, 45, 46, 47, 48, 49, 52, 54, 56, 58, 61, 62, 67, 68, 69, 70, 71, 72, 75, 77, 78, 79, 80, 81, 88, 90, 91, 92, 93	7, 12, 13, 14, 15, 16, 18, 19, 20, 21, 22, 23, 24, 26, 39, 40, 41, 42, 43, 50, 51, 53, 55, 57, 59, 60, 63, 64, 65, 66, 73, 74, 76, 82, 83, 84, 85, 86, 87, 89, 94

POSITION OPEN CAVITIES (POSIZIONE CAVITA' APERTE)	POSITION CLOSED CAVITIES (POSIZIONE CAVITA' CHIUSE)
7, 8, 9, 10, 11, 12, 13, 17, 20, 22, 25, 26, 28, 29, 30, 31, 32, 33, 34, 35, 36, 37, 38, 44, 45, 46, 47, 51, 52, 54, 56, 61, 62, 64, 65, 68, 69, 71, 72, 74, 77, 78, 79, 80, 83, 84, 86, 87, 90, 91, 93, 94	14, 15, 16, 18, 19, 21, 23, 24, 27, 39, 40, 41, 42, 43, 48, 49, 50, 53, 55, 57, 58, 59, 60, 63, 66, 67, 70, 73, 75, 76, 81, 82, 85, 88, 89, 92

POSITION OPEN CAVITIES (POSIZIONE CAVITA' APERTE)	POSITION CLOSED CAVITIES (POSIZIONE CAVITA' CHIUSE)
8, 9, 10, 11, 12, 13, 17, 20, 22, 25, 28, 29, 30, 31, 38, 45, 46, 51, 52, 54, 56, 64, 65, 68, 69, 71, 72, 74, 77, 78, 79, 80, 83, 84, 86, 87, 90, 93, 94	7, 14, 15, 16, 18, 19, 21, 23, 24, 26, 27, 32, 33, 34, 35, 36, 37, 39, 40, 41, 42, 43, 44, 47, 48, 49, 50, 53, 55, 57, 58, 59, 60, 61, 62, 63, 66, 67, 70, 73, 75, 76, 81, 82, 85, 88, 89, 91, 92

CAVITY MASK APPLICATIONS (APPLICAZIONE COPERCHIO CAVITA')

P/N	1-284871-0	1-284871-1	1-284871-2	1-284871-3	1-284871-4	1-284871-5
APPLICATION (APPLICAZIONE)	178 1.3 223 Doblò RST 2005 Motore Diesel	1910 JTD Fase 4 223 Restyling	169 1.3 JTD	186	192 1.9 E4 194 198 939 F4 841 20v F4 937 947	250 2.3 MJ 250 3.0 MJ FULL OPTIONALS + FILTRO GASOLIO RISCALDATO

THIS DRAWING IS A CONTROLLED DOCUMENT FOR TYCO ELECTRONICS CORPORATION. IT IS SUBJECT TO CHANGE AND THE CONTROLLING ENGINEERING ORGANIZATION SHOULD BE CONTACTED FOR THE LATEST REVISION.

DIMENSIONS: mm	TOLERANCES UNLESS OTHERWISE SPECIFIED:	DWN: M. POLIZZI 05DEC2002	
	0 PLC ±0.3	CHK: O. CANUTO 05DEC2002	
	1 PLC ±0.3	APVD: A. GENTA 05DEC2002	
	2 PLC ±0.2	PRODUCT SPEC: 108-20254	
MATERIAL	FINISH	APPLICATION SPEC: 411-20067	RESTRICTED TO
CUSTOMER DRAWING		WEIGHT: -	SIZE: A2
SCALE: 2:1		CAGE CODE: 00779	DRAWING NO: C-284871
SHEET 3 OF 11		REV: B36	

LOC	DIST	REVISIONS			
P	LTR	DESCRIPTION	DATE	DWN	APVD
-	-	SEE SHEET 1	-	-	-

OBSOLETE P/N 1-284871-6 BLACK AS SHOWN

⚠ POLYAMIDE 6.6 GLASS FILLED BLACK COLOUR
 PA 66 CARICATO VETRO COLORE NERO

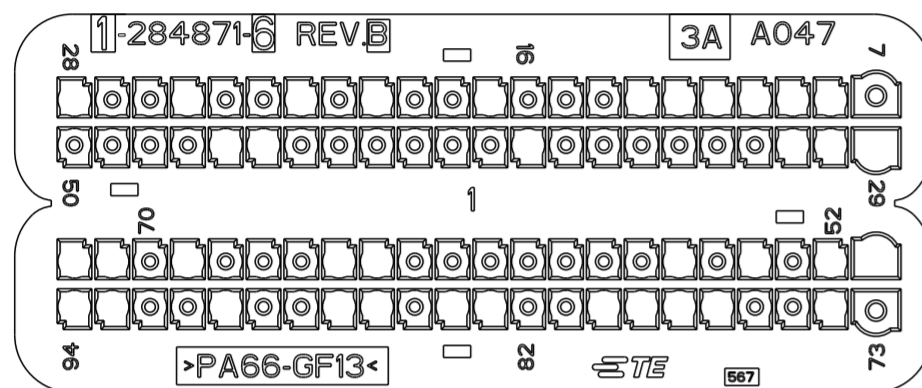

POSITION OPEN CAVITIES
 (POSIZIONE CAVITA' APERTE)

- 8, 9, 10, 11, 12, 13, 17, 20, 22, 25, 28, 29, 30, 31, 38, 45, 46, 51, 52, 54, 56, 64, 65, 69, 71, 72, 74, 77, 78, 79, 80, 83, 84, 86, 87, 90, 93, 94

POSITION CLOSED CAVITIES
 (POSIZIONE CAVITA' CHIUSE)

- 7, 14, 15, 16, 18, 19, 21, 23, 24, 26, 27, 32, 33, 34, 35, 36, 37, 39, 40, 41, 42, 43, 44, 47, 48, 49, 50, 53, 55, 57, 58, 59, 60, 61, 62, 63, 66, 67, 68, 70, 73, 75, 76, 81, 82, 85, 88, 89, 91, 92

OBSOLETE P/N 1-284871-7 GREY AS SHOWN

⚠ POLYAMIDE 6.6 GLASS FILLED GREY COLOUR
 PA 66 CARICATO VETRO COLORE GRIGIO

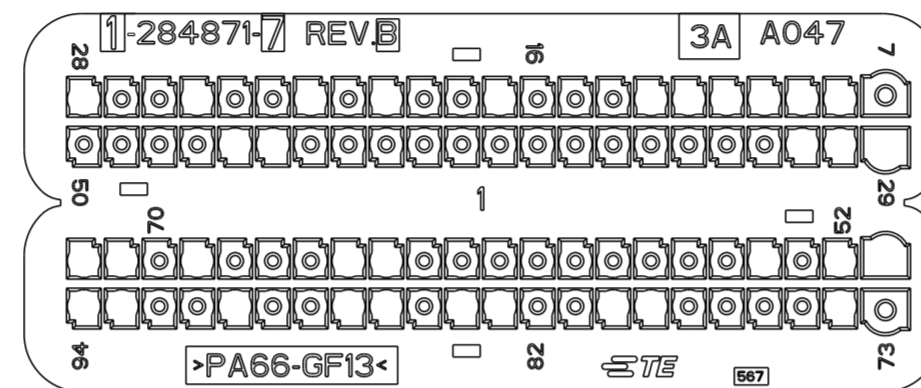

POSITION OPEN CAVITIES
 (POSIZIONE CAVITA' APERTE)

- 8, 9, 10, 11, 12, 13, 17, 20, 22, 25, 28, 29, 30, 31, 45, 46, 51, 52, 54, 64, 65, 69, 71, 72, 74, 79, 80, 83, 84, 86, 87, 90, 93, 94

POSITION CLOSED CAVITIES
 (POSIZIONE CAVITA' CHIUSE)

- 7, 14, 15, 16, 18, 19, 21, 23, 24, 26, 27, 32, 33, 34, 35, 36, 37, 38, 39, 40, 41, 42, 43, 44, 47, 48, 49, 50, 53, 55, 56, 57, 58, 59, 60, 61, 62, 63, 66, 67, 68, 70, 73, 75, 76, 77, 78, 81, 82, 85, 88, 89, 91, 92

OBSOLETE P/N 1-284871-8 BROWN AS SHOWN

⚠ POLYAMIDE 6.6 GLASS FILLED BROWN COLOUR
 PA 66 CARICATO VETRO COLORE MARRONE

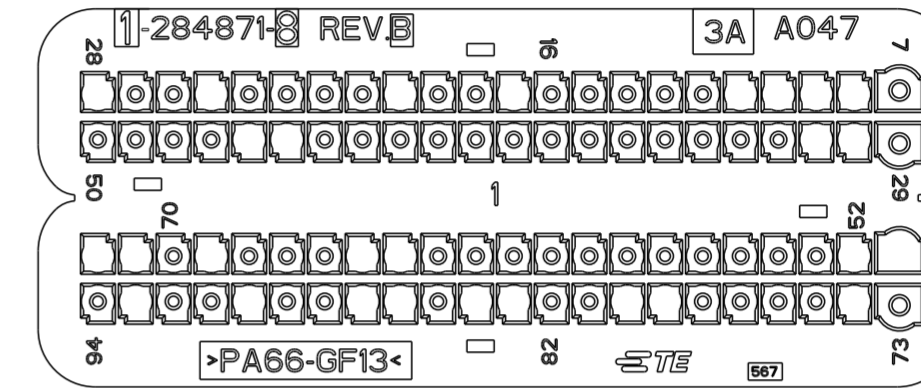

POSITION OPEN CAVITIES
 (POSIZIONE CAVITA' APERTE)

- 8, 9, 10, 11, 17, 20, 25, 28, 30, 31, 45, 46, 51, 52, 64, 65, 69, 71, 72, 74, 79, 80, 83, 84, 86, 87, 90, 93

POSITION CLOSED CAVITIES
 (POSIZIONE CAVITA' CHIUSE)

- 7, 12, 13, 14, 15, 16, 18, 19, 21, 22, 23, 24, 26, 27, 29, 32, 33, 34, 35, 36, 37, 38, 39, 40, 41, 42, 43, 44, 47, 48, 49, 50, 53, 54, 55, 56, 57, 58, 59, 60, 61, 62, 63, 66, 67, 68, 70, 73, 75, 76, 77, 78, 81, 82, 85, 88, 89, 91, 92, 94

P/N 1-284871-9 GREEN AS SHOWN

⚠ POLYAMIDE 6.6 GLASS FILLED GREEN COLOUR
 PA 66 CARICATO VETRO COLORE VERDE

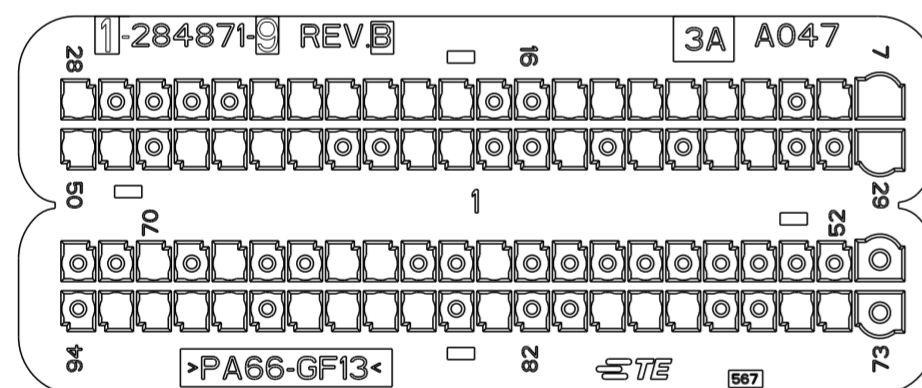

POSITION OPEN CAVITIES
 (POSIZIONE CAVITA' APERTE)

- 7, 8, 10, 11, 12, 13, 14, 15, 18, 19, 20, 21, 22, 23, 28, 29, 32, 33, 35, 37, 40, 41, 44, 45, 46, 47, 49, 50, 61, 64, 65, 68, 70, 74, 75, 78, 79, 80, 83, 85, 86, 87, 88, 90, 91, 92, 93

POSITION CLOSED CAVITIES
 (POSIZIONE CAVITA' CHIUSE)

- 9, 16, 17, 24, 25, 26, 27, 30, 31, 34, 36, 38, 39, 42, 43, 48, 51, 52, 53, 54, 55, 56, 57, 58, 59, 60, 62, 63, 66, 67, 69, 71, 72, 73, 76, 77, 81, 82, 84, 89, 94

P/N 2-284871-0 BLUE AS SHOWN

⚠ POLYAMIDE 6.6 GLASS FILLED BLUE COLOUR
 PA 66 CARICATO VETRO COLORE BLU

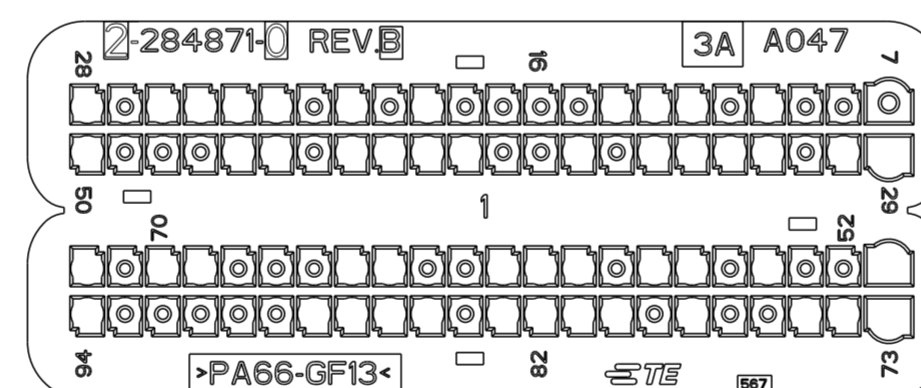

POSITION OPEN CAVITIES
 (POSIZIONE CAVITA' APERTE)

- 10, 12, 13, 14, 19, 21, 23, 24, 25, 26, 28, 29, 30, 32, 33, 34, 35, 37, 40, 41, 42, 43, 45, 46, 50, 51, 54, 56, 57, 59, 60, 61, 64, 65, 69, 70, 72, 73, 74, 75, 78, 80, 81, 82, 83, 85, 86, 87, 88, 94

POSITION CLOSED CAVITIES
 (POSIZIONE CAVITA' CHIUSE)

- 7, 8, 9, 11, 15, 16, 17, 18, 20, 22, 27, 31, 36, 38, 39, 44, 47, 48, 49, 52, 53, 55, 58, 62, 63, 66, 67, 68, 71, 76, 77, 79, 84, 89, 90, 91, 92, 93

P/N 2-284871-1 BLACK AS SHOWN

⚠ POLYAMIDE 6.6 GLASS FILLED BLACK COLOUR
 PA 66 CARICATO VETRO COLORE NERO

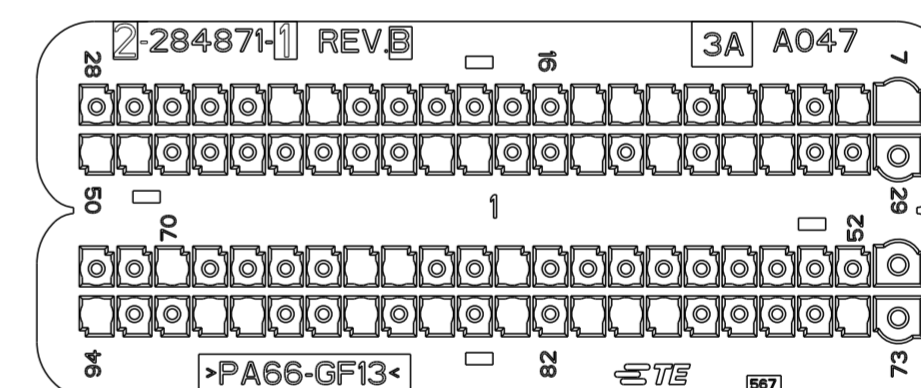

POSITION OPEN CAVITIES
 (POSIZIONE CAVITA' APERTE)

- 7, 8, 10, 11, 13, 14, 15, 22, 23, 32, 33, 35, 37, 40, 41, 49, 50, 61, 64, 65, 70, 74, 79, 80, 81, 83, 85, 87, 90, 91, 94

POSITION CLOSED CAVITIES
 (POSIZIONE CAVITA' CHIUSE)

- 9, 12, 16, 17, 18, 19, 20, 21, 24, 25, 26, 27, 28, 29, 30, 31, 34, 36, 38, 39, 42, 43, 44, 45, 46, 47, 48, 51, 52, 53, 54, 55, 56, 57, 58, 59, 60, 62, 63, 66, 67, 68, 69, 71, 72, 73, 75, 76, 77, 78, 82, 84, 86, 88, 89, 92, 93

CAVITY MASK APPLICATIONS (APPLICAZIONE COPERCHIO CAVITA')

P/N	1-284871-6	1-284871-7	1-284871-8	1-284871-9	2-284871-0	2-284871-1
APPLICATION (APPLICAZIONE)	250 2.3 MJ 250 3.0 MJ FULL OPTIONALS	250 2.3 MJ 250 3.0 MJ SONDA LAMBDA CONDIZIONATO	250 2.3 MJ 250 3.0 MJ SONDA LAMBDA	843 FL (1.3 SDE 75CV) 843FL/350/848 (1.3 SDE 90CV)	263 1.3 Euro 5 S&S (Filtro risc. + blow by diagnostico)	312 (1.3 SDE)

THIS DRAWING IS A CONTROLLED DOCUMENT FOR TYCO ELECTRONICS CORPORATION. IT IS SUBJECT TO CHANGE AND THE CONTROLLING ENGINEERING ORGANIZATION SHOULD BE CONTACTED FOR THE LATEST REVISION.

DIMENSIONS: mm

TOLERANCES UNLESS OTHERWISE SPECIFIED:
 0 PLC ±0.3
 1 PLC ±0.3
 2 PLC ±0.2
 3 PLC ±
 4 PLC ±
 ANGLES ±1°
 FINISH

MATERIAL

DWN M. POLIZZI 05DEC2002
 CHK O. CANUTO 05DEC2002
 APVD A. GENTA 05DEC2002

PRODUCT SPEC 108-20254
 APPLICATION SPEC 411-20067
 WEIGHT -
 CUSTOMER DRAWING

TE Connectivity

NAME CAVITY MASK FOR 94 POS. CONNECTOR (COPERCHIO CAVITA' PER CONNETTORE 94 POSIZIONI)

SIZE A2 CAGE CODE 00779 DRAWING NO C-284871 RESTRICTED TO -

SCALE 3:1 SHEET 4 OF 11 REV B36

LOC	DIST	REVISIONS					
		P	LTR	DESCRIPTION	DATE	DWN	APVD
		-		SEE SHEET 1			

P/N 2-284871-2 GREY AS SHOWN

⚠ POLYAMIDE 6.6 GLASS FILLED GREY COLOUR
 PA 66 CARICATO VETRO COLORE GRIGIO

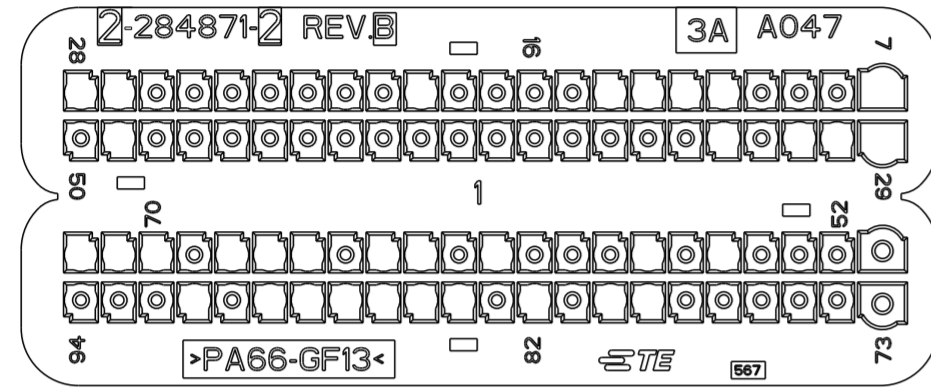

P/N 2-284871-3 BROWN AS SHOWN

⚠ POLYAMIDE 6.6 GLASS FILLED BROWN COLOUR
 PA 66 CARICATO VETRO COLORE MARRONE

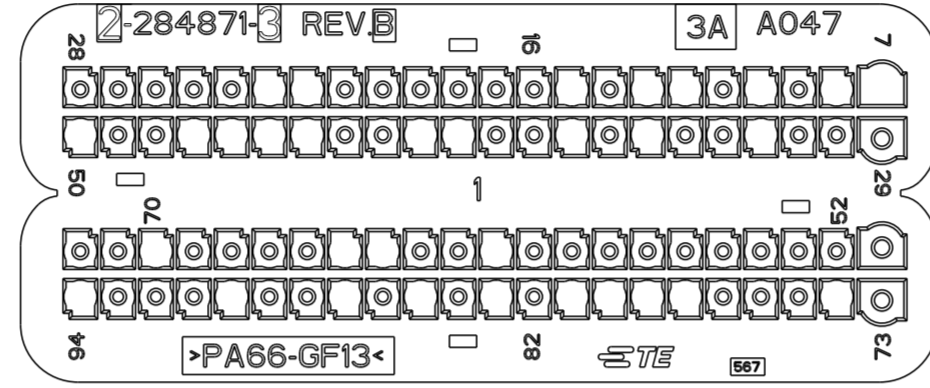

~~OBSOLETE~~ P/N 2-284871-4 GREEN AS SHOWN

⚠ POLYAMIDE 6.6 GLASS FILLED GREEN COLOUR
 PA 66 CARICATO VETRO COLORE VERDE

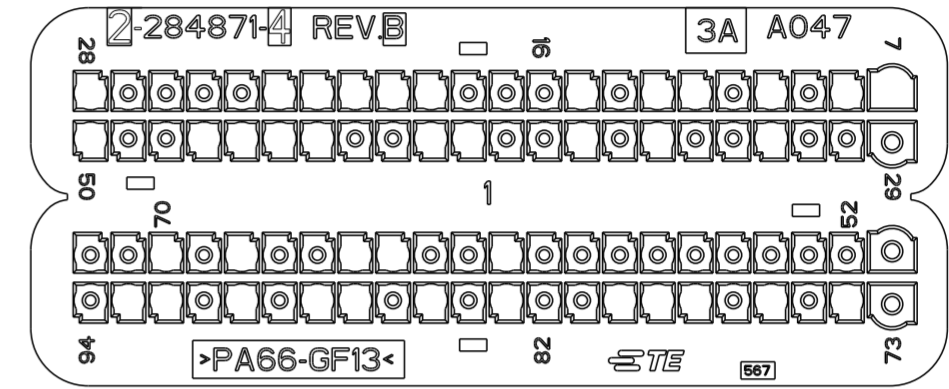

POSITION OPEN CAVITIES (POSIZIONE CAVITA' APERTE) 7, 11, 12, 13, 14, 19, 27, 28, 29, 30, 31, 33, 49, 55, 57, 61, 63, 64, 66, 67, 68, 70, 71, 72, 79, 80, 82, 84, 85, 86, 87, 88, 89, 91	POSITION CLOSED CAVITIES (POSIZIONE CAVITA' CHIUSE) 8, 9, 10, 15, 16, 17, 18, 20, 21, 22, 23, 24, 25, 26, 32, 34, 35, 36, 37, 38, 39, 40, 41, 42, 43, 44, 45, 46, 47, 48, 50, 51, 52, 53, 54, 56, 58, 59, 60, 62, 65, 69, 73, 74, 75, 76, 77, 78, 81, 83, 90, 92, 93, 94
--	---

POSITION OPEN CAVITIES (POSIZIONE CAVITA' APERTE) 7, 8, 10, 12, 13, 15, 22, 23, 32, 35, 37, 40, 41, 44, 45, 46, 47, 50, 61, 64, 65, 70, 74, 78, 79, 80, 81, 83, 85, 87, 90, 94	POSITION CLOSED CAVITIES (POSIZIONE CAVITA' CHIUSE) 9, 11, 14, 16, 17, 18, 19, 20, 21, 24, 25, 26, 27, 28, 29, 30, 31, 33, 34, 36, 38, 39, 42, 43, 48, 49, 51, 52, 53, 54, 55, 56, 57, 58, 59, 60, 62, 63, 66, 67, 68, 69, 71, 72, 73, 75, 76, 77, 82, 84, 86, 88, 89, 91, 92, 93
---	--

POSITION OPEN CAVITIES (POSIZIONE CAVITA' APERTE) 7, 8, 10, 12, 13, 15, 19, 20, 21, 22, 23, 28, 32, 35, 37, 40, 41, 44, 45, 46, 47, 50, 61, 64, 65, 68, 70, 74, 76, 78, 79, 80, 83, 85, 87, 88, 90, 92, 93	POSITION CLOSED CAVITIES (POSIZIONE CAVITA' CHIUSE) 9, 11, 14, 16, 17, 18, 24, 25, 26, 27, 29, 30, 31, 33, 34, 36, 38, 39, 42, 43, 48, 49, 51, 52, 53, 54, 55, 56, 57, 58, 59, 60, 62, 63, 66, 67, 69, 71, 72, 73, 75, 77, 81, 82, 84, 86, 89, 91, 94
--	--

P/N 2-284871-5 BLUE AS SHOWN

⚠ POLYAMIDE 6.6 GLASS FILLED BLUE COLOUR
 PA 66 CARICATO VETRO COLORE BLU

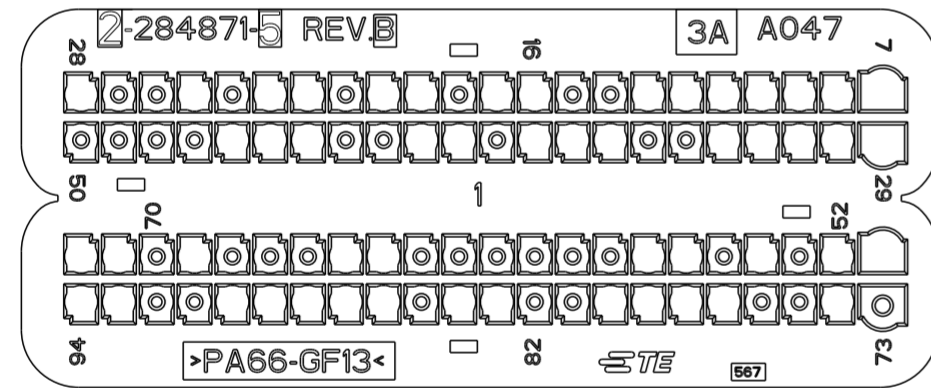

P/N 2-284871-6 BLACK AS SHOWN

⚠ POLYAMIDE 6.6 GLASS FILLED BLACK COLOUR
 PA 66 CARICATO VETRO COLORE NERO

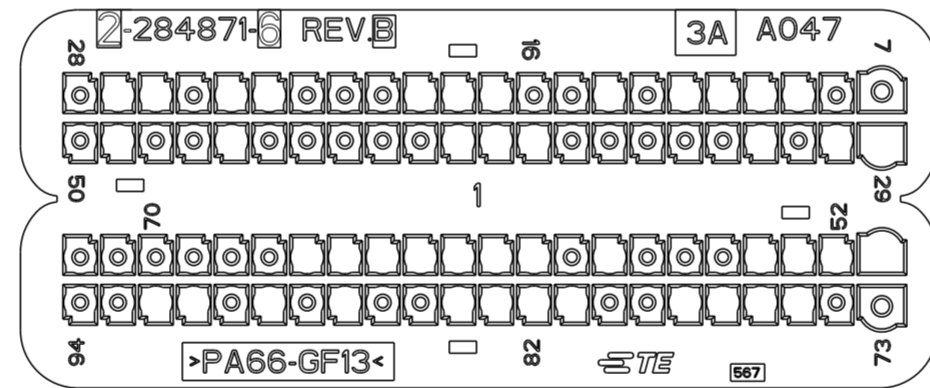

P/N 2-284871-7 GREY AS SHOWN

⚠ POLYAMIDE 6.6 GLASS FILLED GREY COLOUR
 PA 66 CARICATO VETRO COLORE GRIGIO

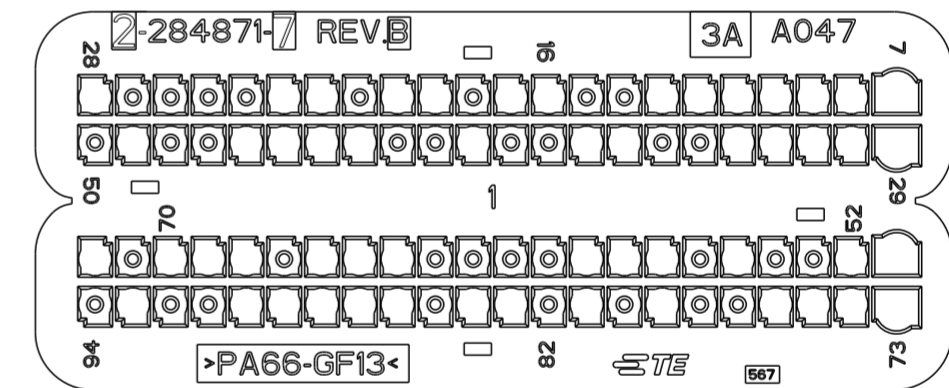

POSITION OPEN CAVITIES (POSIZIONE CAVITA' APERTE) 7, 8, 9, 10, 11, 12, 13, 16, 17, 19, 20, 22, 23, 25, 28, 29, 30, 31, 32, 33, 36, 37, 38, 40, 41, 44, 45, 46, 51, 52, 54, 56, 57, 64, 65, 69, 71, 72, 74, 77, 78, 79, 80, 83, 84, 86, 87, 88, 89, 90, 93, 94	POSITION CLOSED CAVITIES (POSIZIONE CAVITA' CHIUSE) 14, 15, 18, 21, 24, 26, 27, 34, 35, 39, 42, 43, 47, 48, 49, 50, 53, 55, 58, 59, 60, 61, 62, 63, 66, 67, 68, 70, 73, 75, 76, 81, 82, 85, 91, 92
--	---

POSITION OPEN CAVITIES (POSIZIONE CAVITA' APERTE) 9, 10, 11, 12, 14, 17, 18, 19, 23, 24, 26, 27, 29, 30, 32, 38, 39, 40, 46, 49, 51, 52, 53, 54, 58, 60, 61, 62, 63, 64, 65, 66, 75, 76, 77, 78, 81, 82, 83, 84, 87, 89, 91, 92.	POSITION CLOSED CAVITIES (POSIZIONE CAVITA' CHIUSE) 7, 8, 13, 15, 16, 20, 21, 22, 25, 28, 31, 33, 34, 35, 36, 37, 41, 42, 43, 44, 45, 47, 48, 50, 55, 56, 57, 59, 67, 68, 69, 70, 71, 72, 73, 74, 79, 80, 85, 86, 88, 90, 93, 94.
--	---

POSITION OPEN CAVITIES (POSIZIONE CAVITA' APERTE) 7, 8, 9, 10, 11, 12, 13, 16, 17, 19, 20, 22, 23, 28, 29, 30, 31, 32, 33, 36, 37, 40, 43, 44, 45, 46, 49, 51, 52, 55, 57, 58, 59, 64, 65, 66, 68, 69, 70, 72, 73, 74, 75, 76, 79, 81, 83, 84, 86, 87, 88, 89, 90, 93	POSITION CLOSED CAVITIES (POSIZIONE CAVITA' CHIUSE) 14, 15, 18, 21, 24, 25, 26, 27, 34, 35, 38, 39, 41, 42, 47, 48, 50, 53, 54, 56, 60, 61, 62, 63, 67, 71, 77, 78, 80, 82, 85, 91, 92, 94
--	---

CAVITY MASK APPLICATIONS (APPLICAZIONE COPERCHIO CAVITA')

P/N	2-284871-2	2-284871-3	2-284871-4	2-284871-5	2-284871-6	2-284871-7
APPLICATION (APPLICAZIONE)	1.4 16v bz ASPIRATO/BENZINA	225 (1.3 SDE)	310-323 (1.3 SDE)	844-198-199 955 1.6 JTD	DAIMLER CHRYSLER DODGE JC49	940 1.6 / 2.0 (MDE Filtro riscaldato)

THIS DRAWING IS A CONTROLLED DOCUMENT FOR TYCO ELECTRONICS CORPORATION. IT IS SUBJECT TO CHANGE AND THE CONTROLLING ENGINEERING ORGANIZATION SHOULD BE CONTACTED FOR THE LATEST REVISION.

DIMENSIONS: mm

TOLERANCES UNLESS OTHERWISE SPECIFIED:
 0 PLC ±0.3
 1 PLC ±0.3
 2 PLC ±0.2
 3 PLC ±
 4 PLC ±
 ANGLES ±°

MATERIAL:

DWN: M. POLIZZI 05DEC2002
 CHK: O. CANUTO 05DEC2002
 APVD: A. GENIA 05DEC2002

PRODUCT SPEC: 108-20254
 APPLICATION SPEC: 411-20067

WEIGHT: -

CUSTOMER DRAWING

SCALE: 3:1

SHEET 5 OF 11

REV: B36

NAME: CAVITY MASK FOR 94 POS. CONNECTOR (COPERCHIO CAVITA' PER CONNETTORE 94 POSIZIONI)

SIZE: A2 CAGE CODE: 00779 DRAWING NO: C-284871 RESTRICTED TO: -

TE Connectivity

LOC		DIST		REVISIONS			
P	LTR	DESCRIPTION	DATE	DWN	APVD		
-	-	SEE SHEET 1	-	-	-		

P/N 2-284871-8 BROWN AS SHOWN

△ POLYAMIDE 6.6 GLASS FILLED BROWN COLOUR
 PA 66 CARICATO VETRO COLORE MARRONE

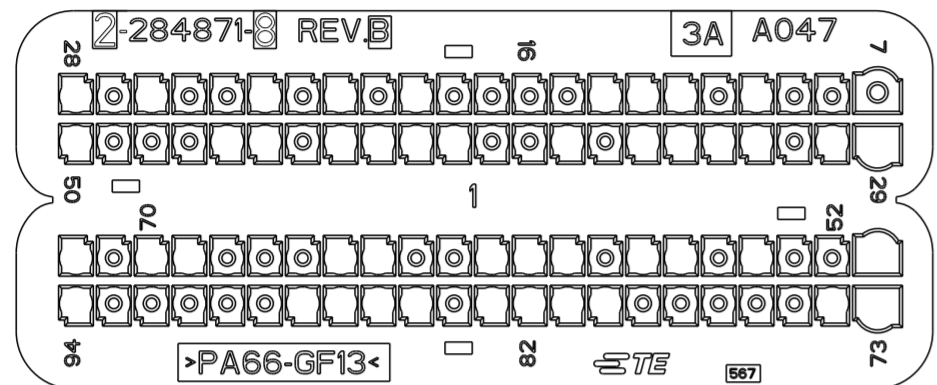

POSITION OPEN CAVITIES (POSIZIONE CAVITA' APERTE)	POSITION CLOSED CAVITIES (POSIZIONE CAVITA' CHIUSE)
10, 12, 13, 14, 19, 21, 23, 26, 28, 29, 30, 32, 33, 34, 35, 37, 40, 41, 42, 43, 45, 46, 50, 51, 54, 56, 57, 59, 60, 61, 64, 65, 69, 70, 72, 73, 74, 80, 81, 82, 83, 85, 86, 87, 88, 94	7, 8, 9, 11, 15, 16, 17, 18, 20, 22, 24, 25, 27, 31, 36, 38, 39, 44, 47, 48, 49, 52, 53, 55, 58, 62, 63, 66, 67, 68, 71, 75, 76, 77, 78, 79, 84, 89, 90, 91, 92, 93

P/N 2-284871-9 GREEN AS SHOWN

△ POLYAMIDE 6.6 GLASS FILLED GREEN COLOUR
 PA 66 CARICATO VETRO COLORE VERDE

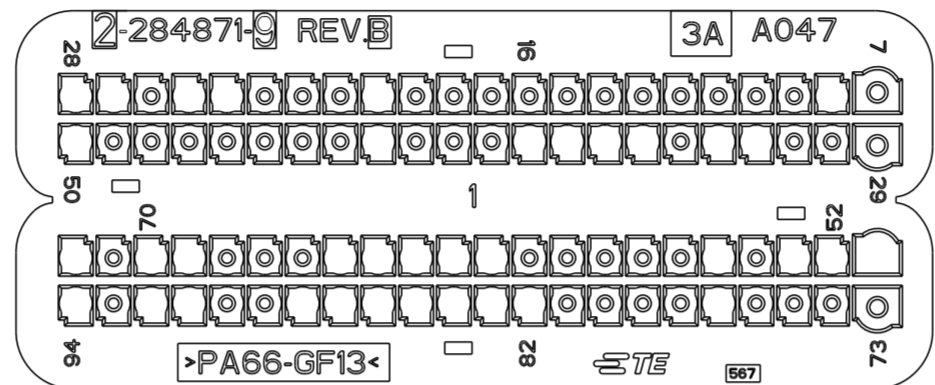

POSITION OPEN CAVITIES (POSIZIONE CAVITA' APERTE)	POSITION CLOSED CAVITIES (POSIZIONE CAVITA' CHIUSE)
8, 20, 24, 25, 27, 28, 32, 33, 35, 36, 37, 38, 42, 50, 51, 52, 53, 55, 61, 62, 63, 64, 65, 69, 70, 72, 77, 82, 83, 84, 85, 86, 87, 88, 91, 92, 94	7, 9, 10, 11, 12, 13, 14, 15, 16, 17, 18, 19, 21, 22, 23, 26, 29, 30, 31, 34, 39, 40, 41, 43, 44, 45, 46, 47, 48, 49, 54, 56, 57, 58, 59, 60, 66, 67, 68, 71, 73, 74, 75, 76, 78, 79, 80, 81, 89, 90, 93

P/N 3-284871-0 BLUE AS SHOWN

△ POLYAMIDE 6.6 GLASS FILLED BLUE COLOUR
 PA 66 CARICATO VETRO COLORE BLU

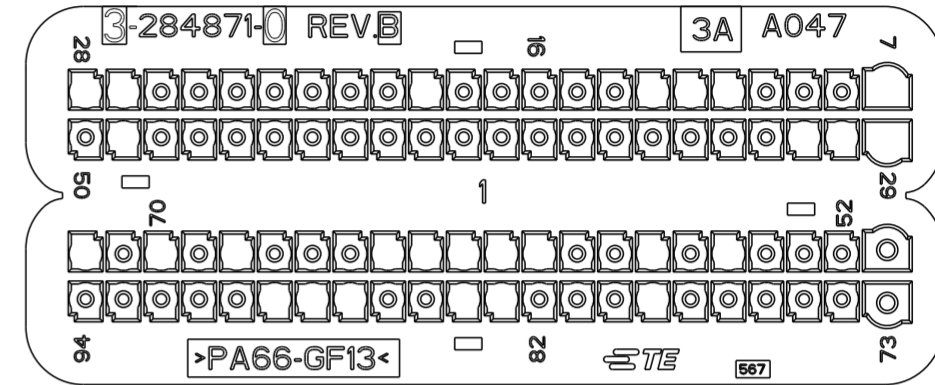

POSITION OPEN CAVITIES (POSIZIONE CAVITA' APERTE)	POSITION CLOSED CAVITIES (POSIZIONE CAVITA' CHIUSE)
7, 11, 12, 13, 19, 27, 28, 29, 30, 31, 49, 55, 57, 60, 61, 62, 63, 64, 68, 70, 72, 79, 83, 84, 87, 88, 89	8, 9, 10, 14, 15, 16, 17, 18, 20, 21, 22, 23, 24, 25, 26, 32, 33, 34, 35, 36, 37, 38, 39, 40, 41, 42, 43, 44, 45, 46, 47, 48, 50, 51, 52, 53, 54, 56, 58, 59, 65, 66, 67, 69, 71, 73, 74, 75, 76, 77, 78, 80, 81, 82, 85, 86, 90, 91, 92, 93, 94

P/N 3-284871-1 BLACK AS SHOWN

△ POLYAMIDE 6.6 GLASS FILLED BLACK COLOUR
 PA 66 CARICATO VETRO COLORE NERO

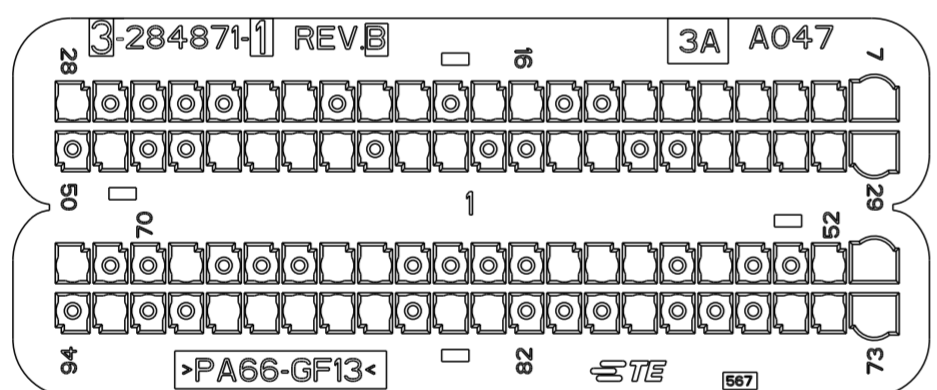

POSITION OPEN CAVITIES (POSIZIONE CAVITA' APERTE)	POSITION CLOSED CAVITIES (POSIZIONE CAVITA' CHIUSE)
7, 8, 9, 10, 11, 12, 13, 16, 17, 19, 20, 22, 23, 28, 29, 30, 31, 32, 33, 36, 37, 40, 41, 43, 44, 45, 46, 49, 51, 52, 55, 57, 58, 59, 64, 65, 69, 72, 73, 74, 75, 79, 83, 84, 86, 87, 88, 89, 90, 93	14, 15, 18, 21, 24, 25, 26, 27, 34, 35, 38, 39, 42, 47, 48, 50, 53, 54, 56, 60, 61, 62, 63, 66, 67, 68, 70, 71, 76, 77, 78, 80, 81, 82, 85, 91, 92, 94

P/N 3-284871-2 GREY AS SHOWN

△ POLYAMIDE 6.6 GLASS FILLED GREY COLOUR
 PA 66 CARICATO VETRO COLORE GRIGIO

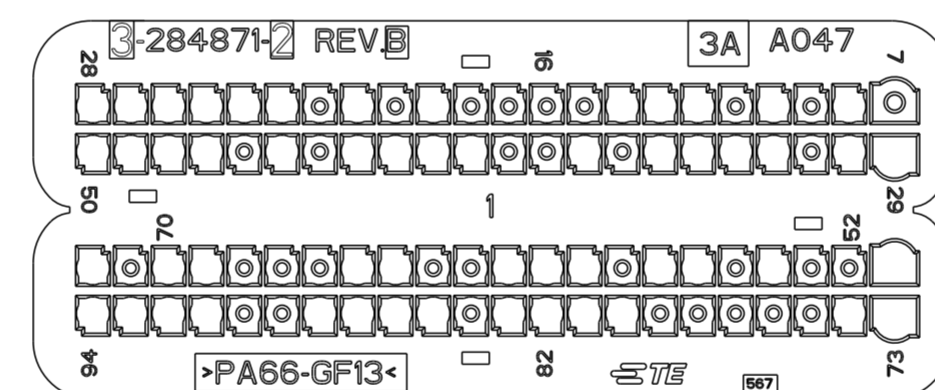

POSITION OPEN CAVITIES (POSIZIONE CAVITA' APERTE)	POSITION CLOSED CAVITIES (POSIZIONE CAVITA' CHIUSE)
8, 10, 12, 13, 14, 19, 21, 23, 24, 25, 26, 27, 28, 29, 30, 32, 33, 34, 35, 37, 40, 41, 42, 43, 45, 47, 48, 49, 50, 51, 54, 56, 57, 59, 60, 61, 64, 65, 69, 70, 72, 73, 74, 80, 81, 82, 83, 85, 86, 87, 88, 91, 92, 93, 94	7, 9, 11, 15, 16, 17, 18, 20, 22, 31, 36, 38, 39, 44, 46, 52, 53, 55, 58, 62, 63, 66, 67, 68, 71, 75, 76, 77, 78, 79, 84, 89, 90

P/N 3-284871-3 GREEN AS SHOWN

△ POLYAMIDE 6.6 GLASS FILLED GREEN COLOUR
 PA 66 CARICATO VETRO COLORE VERDE

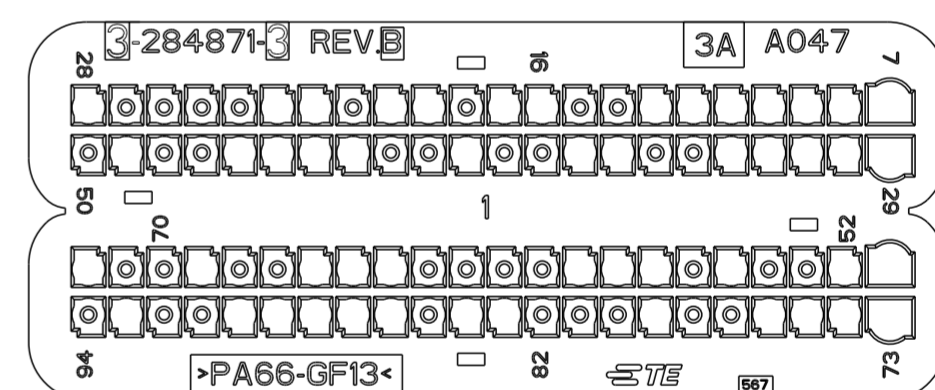

POSITION OPEN CAVITIES (POSIZIONE CAVITA' APERTE)	POSITION CLOSED CAVITIES (POSIZIONE CAVITA' CHIUSE)
7, 8, 9, 10, 11, 12, 13, 16, 17, 19, 20, 22, 23, 28, 29, 30, 31, 32, 33, 36, 37, 40, 43, 44, 45, 46, 49, 51, 52, 55, 57, 58, 59, 64, 65, 66, 69, 72, 73, 74, 75, 76, 79, 83, 84, 86, 87, 88, 89, 90, 93	14, 15, 18, 21, 24, 25, 26, 27, 34, 35, 38, 39, 41, 42, 47, 48, 50, 53, 54, 56, 60, 61, 62, 63, 67, 68, 70, 71, 77, 78, 80, 81, 82, 85, 91, 92, 94

CAVITY MASK APPLICATIONS (APPLICAZIONE COPERCHIO CAVITA')

P/N	2-284871-8	2-284871-9	3-284871-0	3-284871-1	3-284871-2	3-284871-3
APPLICATION (APPLICAZIONE)	1.3 SDE S&S 199 312 263 225 846 955	MULTI AIR S&S 199 1.4 955 1.4	1.4 BZ S&S 312 1.4 16v 263 1.4 16V 940 1.4 TJet	1.6 MDE S&S 199 263 955	1.3 SDE S&S 169 350 848 843	940 1.6 JTD S&S 940 2.0 JTD S&S

THIS DRAWING IS A CONTROLLED DOCUMENT FOR TYCO ELECTRONICS CORPORATION. IT IS SUBJECT TO CHANGE AND THE CONTROLLING ENGINEERING ORGANIZATION SHOULD BE CONTACTED FOR THE LATEST REVISION.

DWN: 05DEC2002
 M. POLIZZI
 CHK: 05DEC2002
 O. CANUO
 APVD: 05DEC2002
 A. GENIA

TE Connectivity

NAME: CAVITY MASK FOR 94 POS. CONNECTOR (COPERCHIO CAVITA' PER CONNETTORE 94 POSIZIONI)

PRODUCT SPEC: 108-20254
 APPLICATION SPEC: 411-20067

SIZE: A2 CAGE CODE: 00779 DRAWING NO: C-284871 RESTRICTED TO: -

MATERIAL: FINISH:

CUSTOMER DRAWING SCALE: 3:1 SHEET: 6 OF 11 REV: B36

LOC		DIST		REVISIONS			
P	LTR	DESCRIPTION	DATE	DWN	APVD		
-	-	SEE SHEET 1	-	-	-		

P/N 3-284871-4 BLUE AS SHOWN

△ POLYAMIDE 6.6 GLASS FILLED BLUE COLOUR
 PA 66 CARICATO VETRO COLORE BLU

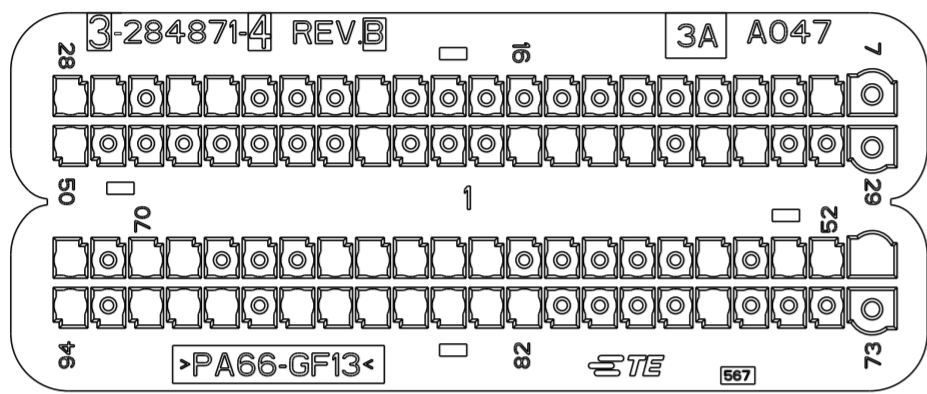

POSITION OPEN CAVITIES (POSIZIONE CAVITA' APERTE)
8, 20, 24, 25, 27, 28, 32, 33, 35, 36, 37, 38, 42, 50, 51, 52, 53, 55, 61, 62, 63, 64, 65, 69, 70, 72, 77, 82, 83, 84, 85, 86, 87, 88, 90, 91, 92, 94

POSITION CLOSED CAVITIES (POSIZIONE CAVITA' CHIUSE)
7, 9, 10, 11, 12, 13, 14, 15, 16, 17, 18, 19, 21, 22, 23, 26, 29, 30, 31, 34, 39, 40, 41, 43, 44, 45, 46, 47, 48, 49, 54, 56, 57, 58, 59, 60, 66, 67, 68, 71, 73, 74, 75, 76, 78, 79, 80, 81, 89, 93

P/N 3-284871-5 BROWN AS SHOWN

△ POLYAMIDE 6.6 GLASS FILLED BROWN COLOUR
 PA 66 CARICATO VETRO COLORE MARRONE

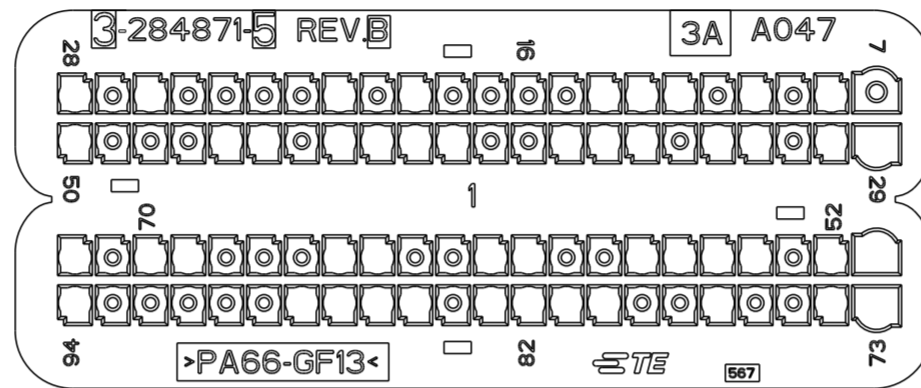

POSITION OPEN CAVITIES (POSIZIONE CAVITA' APERTE)
8, 10, 12, 13, 14, 19, 21, 26, 28, 29, 30, 32, 33, 35, 36, 37, 40, 41, 42, 43, 45, 46, 50, 51, 52, 54, 55, 56, 57, 60, 61, 64, 65, 69, 70, 72, 73, 74, 77, 80, 81, 82, 83, 85, 86, 87, 88, 94

POSITION CLOSED CAVITIES (POSIZIONE CAVITA' CHIUSE)
7, 9, 11, 15, 16, 17, 18, 20, 22, 23, 24, 25, 27, 31, 34, 38, 39, 44, 47, 48, 49, 53, 58, 59, 62, 63, 66, 67, 68, 71, 75, 76, 78, 79, 84, 89, 90, 91, 92, 93

P/N 3-284871-6 BLACK AS SHOWN

△ POLYAMIDE 6.6 GLASS FILLED BLACK COLOUR
 PA 66 CARICATO VETRO COLORE NERO

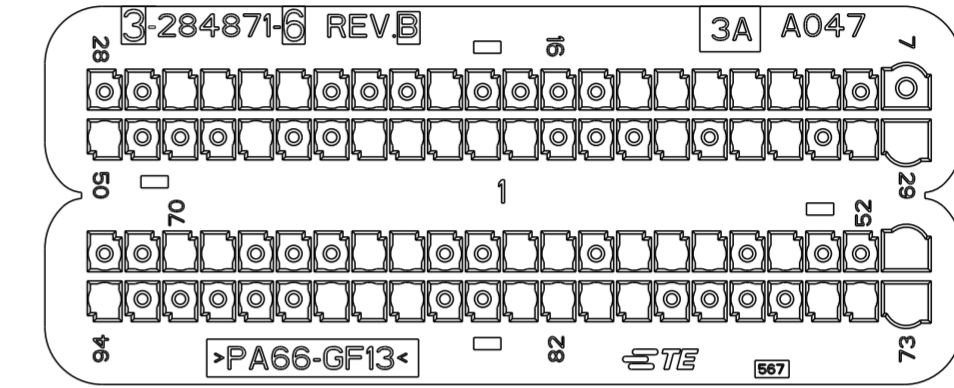

POSITION OPEN CAVITIES (POSIZIONE CAVITA' APERTE)
9, 10, 11, 12, 13, 14, 19, 23, 24, 25, 26, 29, 30, 32, 33, 35, 39, 40, 41, 42, 43, 46, 50, 51, 54, 56, 57, 58, 60, 61, 64, 65, 69, 70, 73, 74, 75, 80, 81, 82, 83, 86, 87, 88, 94

POSITION CLOSED CAVITIES (POSIZIONE CAVITA' CHIUSE)
7, 8, 15, 16, 17, 18, 20, 21, 22, 27, 28, 31, 34, 36, 37, 38, 44, 45, 47, 48, 49, 52, 53, 55, 59, 62, 63, 66, 67, 68, 71, 72, 76, 77, 78, 79, 84, 85, 89, 90, 91, 92, 93

P/N 3-284871-7 GREY AS SHOWN

△ POLYAMIDE 6.6 GLASS FILLED GREY COLOUR
 PA 66 CARICATO VETRO COLORE GRIGIO

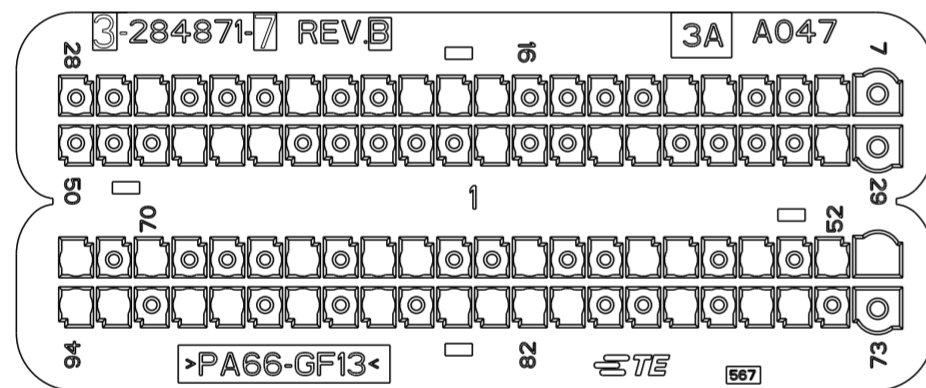

POSITION OPEN CAVITIES (POSIZIONE CAVITA' APERTE)
8, 11, 12, 17, 18, 19, 22, 26, 30, 35, 36, 39, 45, 46, 47, 51, 52, 54, 56, 57, 60, 63, 64, 66, 70, 72, 75, 76, 78, 81, 82, 83, 84, 86, 88, 90, 91, 93, 94

POSITION CLOSED CAVITIES (POSIZIONE CAVITA' CHIUSE)
7, 9, 10, 13, 14, 15, 16, 20, 21, 23, 24, 25, 27, 28, 29, 31, 32, 33, 34, 37, 38, 40, 41, 42, 43, 44, 48, 49, 50, 53, 55, 58, 59, 61, 62, 65, 67, 68, 69, 71, 73, 74, 77, 79, 80, 85, 87, 89, 92

P/N 3-284871-8 BROWN AS SHOWN

△ POLYAMIDE 6.6 GLASS FILLED BROWN COLOUR
 PA 66 CARICATO VETRO COLORE MARRONE

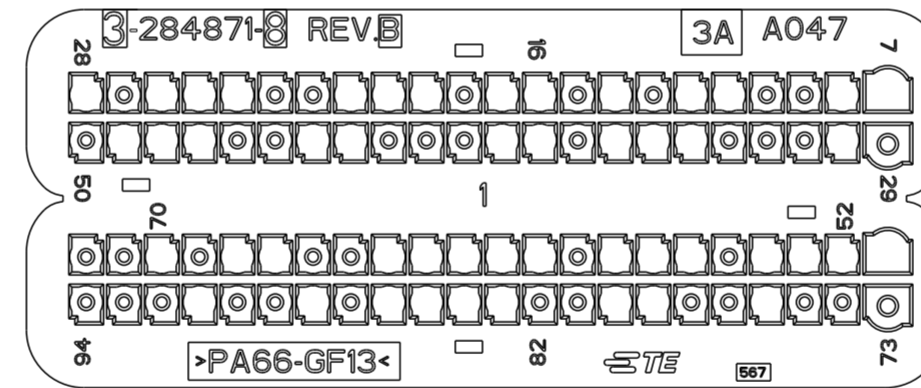

POSITION OPEN CAVITIES (POSIZIONE CAVITA' APERTE)
7, 8, 11, 12, 14, 16, 17, 19, 20, 21, 24, 25, 26, 28, 30, 34, 35, 36, 38, 39, 43, 44, 47, 48, 49, 51, 52, 53, 54, 56, 57, 58, 60, 61, 62, 63, 64, 67, 68, 70, 76, 79, 80, 83, 84, 85, 86, 88, 91

POSITION CLOSED CAVITIES (POSIZIONE CAVITA' CHIUSE)
9, 10, 13, 15, 18, 22, 23, 27, 29, 31, 32, 33, 37, 40, 41, 42, 45, 46, 50, 55, 59, 65, 66, 69, 71, 72, 73, 74, 75, 77, 78, 81, 82, 87, 89, 90, 92, 93, 94

P/N 3-284871-9 GREEN AS SHOWN

△ POLYAMIDE 6.6 GLASS FILLED GREEN COLOUR
 PA 66 CARICATO VETRO COLORE VERDE

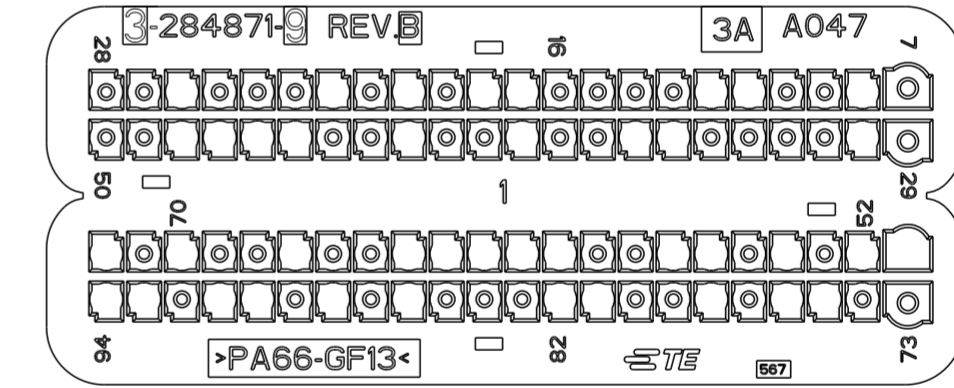

POSITION OPEN CAVITIES (POSIZIONE CAVITA' APERTE)
8, 11, 12, 17, 18, 20, 22, 26, 30, 35, 36, 39, 42, 45, 46, 47, 48, 51, 52, 54, 56, 57, 60, 61, 62, 63, 64, 67, 70, 72, 75, 76, 78, 81, 82, 86, 88, 90, 91, 93, 94

POSITION CLOSED CAVITIES (POSIZIONE CAVITA' CHIUSE)
7, 9, 10, 13, 14, 15, 16, 19, 21, 23, 24, 25, 27, 28, 29, 31, 32, 33, 34, 37, 38, 40, 41, 43, 44, 49, 50, 53, 55, 58, 59, 65, 66, 68, 69, 71, 73, 74, 77, 79, 80, 83, 84, 85, 87, 89, 92

CAVITY MASK APPLICATIONS (APPLICAZIONE COPERCHIO CAVITA')

P/N	3-284871-4	3-284871-5	3-284871-6	3-284871-7	3-284871-8	3-284871-9
APPLICATION (APPLICAZIONE)	MULTI AIR-TECH B 199 0.9 312 0.9 846 0.9 330 0.9 940 1.4 955 1.4	225 (1.3 SDE Euro5+)	DUCATO (250) MOTORE FIA	DUCATO (250) MOTORE FIC	DAILY FL 2011 FIA Motorizzazione 2.3	DAILY FL 2011 FIC Motorizzazione 3.0

THIS DRAWING IS A CONTROLLED DOCUMENT FOR TYCO ELECTRONICS CORPORATION. IT IS SUBJECT TO CHANGE AND THE CONTROLLING ENGINEERING ORGANIZATION SHOULD BE CONTACTED FOR THE LATEST REVISION.

DIMENSIONS: mm

TOLERANCES UNLESS OTHERWISE SPECIFIED:

0 PLC	±0.3
1 PLC	±0.3
2 PLC	±0.2
3 PLC	±
4 PLC	±
ANGLES	±1°
FINISH	

MATERIAL

DWN: 05DEC2002
 M. POLIZZI
 CHK: 05DEC2002
 O. CANUTO
 APVD: 05DEC2002
 A. GENTA

PRODUCT SPEC: 108-20254
 APPLICATION SPEC: 411-20067

NAME: CAVITY MASK FOR 94 POS. CONNECTOR (COPERCHIO CAVITA' PER CONNETTORE 94 POSIZIONI)

SIZE: A2 CAGE CODE: 00779 DRAWING NO: C-284871 RESTRICTED TO: -

WEIGHT: -

CUSTOMER DRAWING

SCALE: 3:1 SHEET 7 OF 11 REV: B36

LOC	DIST	REVISIONS					
		P	LTR	DESCRIPTION	DATE	DWN	APVD
	-			SEE SHEET 1			

OBSOLETE P/N 4-284871-0 BLUE AS SHOWN

△ POLYAMIDE 6.6 GLASS FILLED BLUE COLOUR
 PA 66 CARICATO VETRO COLORE BLU

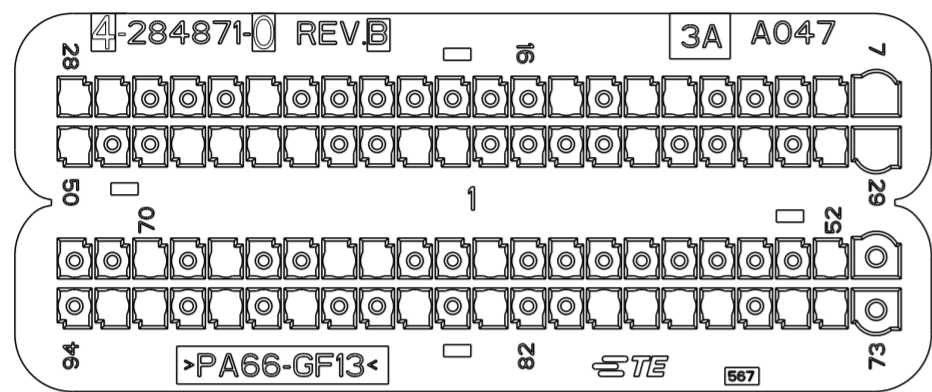

POSITION OPEN CAVITIES (POSIZIONE CAVITA' APERTE)
7, 8, 12, 13, 15, 23, 27, 28, 29, 30, 32, 35, 40, 41, 44, 45, 46, 47, 50, 52, 61, 64, 65, 68, 70, 74, 75, 77, 78, 79, 80, 83, 85, 88, 90, 92, 93

POSITION CLOSED CAVITIES (POSIZIONE CAVITA' CHIUSE)
9, 10, 11, 14, 16, 17, 18, 19, 20, 21, 22, 24, 25, 26, 31, 33, 34, 36, 37, 38, 39, 42, 43, 48, 49, 51, 53, 55, 56, 57, 58, 59, 60, 62, 63, 66, 67, 69, 71, 72, 73, 76, 81, 82, 84, 86, 87, 89, 91, 94

OBSOLETE P/N 4-284871-1 BLACK AS SHOWN

△ POLYAMIDE 6.6 GLASS FILLED BLACK COLOUR
 PA 66 CARICATO VETRO COLORE NERO

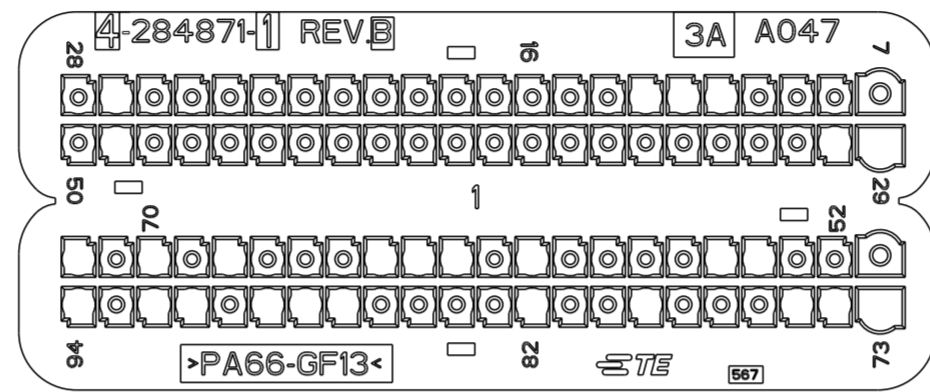

POSITION OPEN CAVITIES (POSIZIONE CAVITA' APERTE)
11, 12, 13, 27, 29, 30, 49, 54, 55, 60, 62, 63, 64, 68, 70, 72, 73, 74, 75, 79, 82, 87, 88, 89, 91, 92, 94

POSITION CLOSED CAVITIES (POSIZIONE CAVITA' CHIUSE)
7, 8, 9, 10, 14, 15, 16, 17, 18, 19, 20, 21, 22, 23, 24, 25, 26, 28, 31, 32, 33, 34, 35, 36, 37, 38, 39, 40, 41, 42, 43, 44, 45, 46, 47, 48, 50, 51, 52, 53, 56, 57, 58, 59, 61, 65, 66, 67, 69, 71, 76, 77, 78, 80, 81, 83, 84, 85, 86, 90, 93

OBSOLETE P/N 4-284871-2 GREY AS SHOWN

△ POLYAMIDE 6.6 GLASS FILLED GREY COLOUR
 PA 66 CARICATO VETRO COLORE GRIGIO

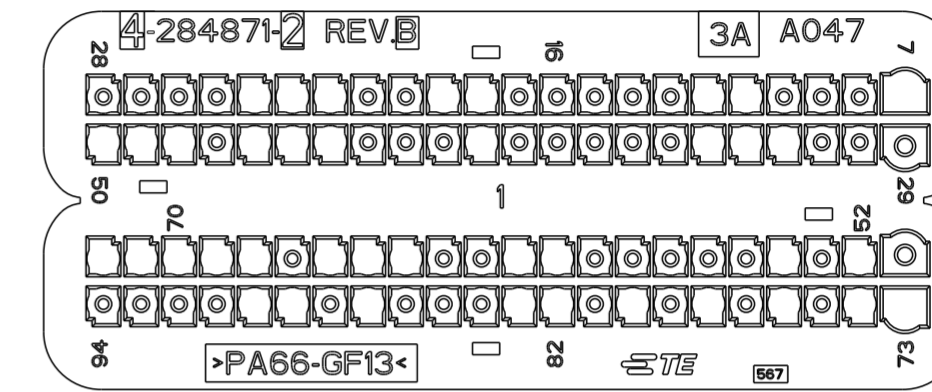

POSITION OPEN CAVITIES (POSIZIONE CAVITA' APERTE)
7, 11, 12, 18, 19, 22, 23, 24, 32, 33, 34, 40, 44, 45, 46, 48, 49, 50, 52, 54, 60, 61, 64, 65, 66, 68, 69, 70, 71, 72, 73, 74, 76, 78, 80, 82, 83, 87, 89, 90

POSITION CLOSED CAVITIES (POSIZIONE CAVITA' CHIUSE)
8, 9, 10, 13, 14, 15, 16, 17, 20, 21, 25, 26, 27, 28, 29, 30, 31, 35, 36, 37, 38, 39, 41, 42, 43, 47, 51, 53, 55, 56, 57, 58, 59, 62, 63, 67, 75, 77, 79, 81, 84, 85, 86, 88, 91, 92, 93, 94

OBSOLETE P/N 4-284871-3 BROWN AS SHOWN

△ POLYAMIDE 6.6 GLASS FILLED BROWN COLOUR
 PA 66 CARICATO VETRO COLORE MARRONE

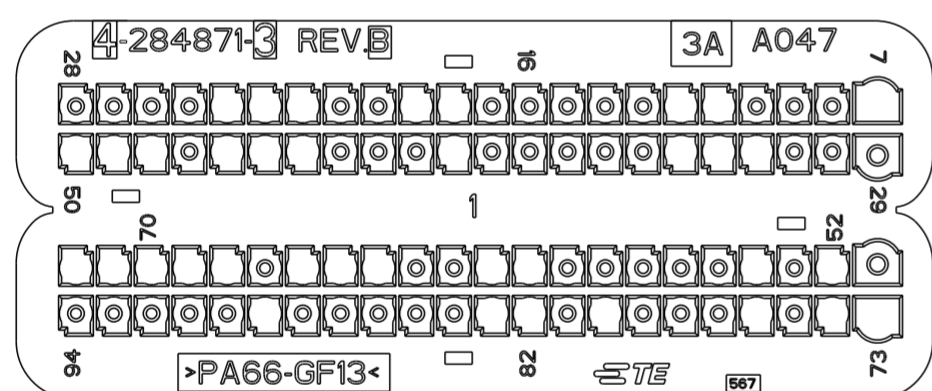

POSITION OPEN CAVITIES (POSIZIONE CAVITA' APERTE)
7, 11, 12, 18, 19, 22, 23, 24, 32, 33, 34, 40, 44, 45, 46, 48, 49, 50, 52, 54, 60, 61, 64, 65, 66, 68, 69, 70, 71, 72, 73, 74, 76, 80, 82, 83, 89

POSITION CLOSED CAVITIES (POSIZIONE CAVITA' CHIUSE)
8, 9, 10, 13, 14, 15, 16, 17, 20, 21, 25, 26, 27, 28, 29, 30, 31, 35, 36, 37, 38, 39, 41, 42, 43, 47, 51, 53, 55, 56, 57, 58, 59, 62, 63, 67, 75, 77, 78, 79, 81, 84, 85, 86, 87, 88, 90, 91, 92, 93, 94

P/N 4-284871-4 GREEN AS SHOWN

△ POLYAMIDE 6.6 GLASS FILLED GREEN COLOUR
 PA 66 CARICATO VETRO COLORE VERDE

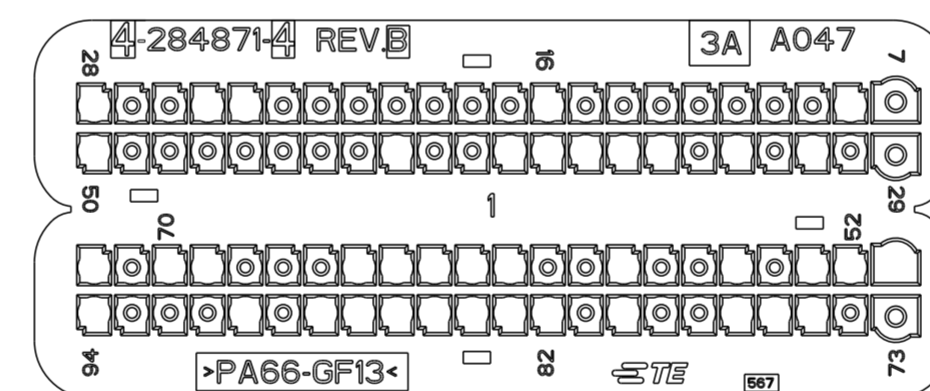

POSITION OPEN CAVITIES (POSIZIONE CAVITA' APERTE)
8, 16, 24, 25, 28, 31, 33, 35, 36, 37, 38, 39, 42, 50, 51, 52, 53, 55, 58, 61, 62, 63, 64, 65, 69, 70, 72, 75, 76, 77, 80, 82, 83, 84, 85, 86, 87, 88, 90, 94

POSITION CLOSED CAVITIES (POSIZIONE CAVITA' CHIUSE)
7, 9, 10, 11, 12, 13, 14, 15, 17, 18, 19, 20, 21, 22, 23, 26, 27, 29, 30, 32, 34, 40, 41, 43, 44, 45, 46, 47, 48, 49, 54, 56, 57, 59, 60, 66, 67, 68, 71, 73, 74, 78, 79, 81, 89, 91, 92, 93

P/N 4-284871-5 BLUE AS SHOWN

△ POLYAMIDE 6.6 GLASS FILLED BLUE COLOUR
 PA 66 CARICATO VETRO COLORE BLU

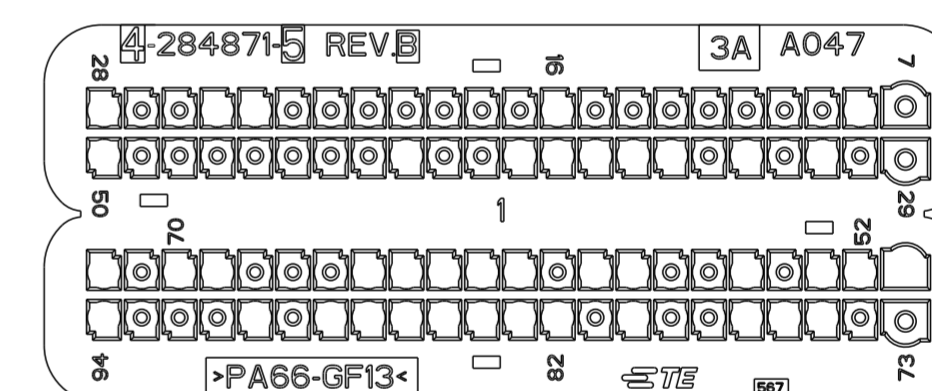

POSITION OPEN CAVITIES (POSIZIONE CAVITA' APERTE)
8, 16, 24, 25, 28, 31, 33, 35, 36, 37, 38, 39, 42, 50, 51, 52, 53, 55, 58, 59, 61, 62, 63, 64, 65, 69, 70, 72, 75, 76, 77, 80, 82, 83, 84, 85, 86, 87, 88, 90, 94

POSITION CLOSED CAVITIES (POSIZIONE CAVITA' CHIUSE)
7, 9, 10, 11, 12, 13, 14, 15, 17, 18, 19, 20, 21, 22, 23, 26, 27, 29, 30, 32, 34, 40, 41, 43, 44, 45, 46, 47, 48, 49, 54, 56, 57, 60, 66, 67, 68, 71, 73, 74, 78, 79, 81, 89, 91, 92, 93

CAVITY MASK APPLICATIONS (APPLICAZIONE COPERCHIO CAVITA')

P/N	4-284871-0	4-284871-1	4-284871-2	4-284871-3	4-284871-4	4-284871-5
APPLICATION (APPLICAZIONE)	1.3L SDE 75 PS ENGINE	1.4L FIRE 90 PS ENGINE	BSIV	BSIII	500 NA	MY 2014 - PF

THIS DRAWING IS A CONTROLLED DOCUMENT FOR TYCO ELECTRONICS CORPORATION
 IT IS SUBJECT TO CHANGE AND THE CONTROLLING ENGINEERING ORGANIZATION
 SHOULD BE CONTACTED FOR THE LATEST REVISION.

DIMENSIONS: mm

TOLERANCES UNLESS OTHERWISE SPECIFIED:
 0 PLC ±0.3
 1 PLC ±0.3
 2 PLC ±0.2
 3 PLC ±
 4 PLC ±
 ANGLES ±1°
 FINISH

MATERIAL

DWN M. POLIZZI 05DEC2002
 CHK O. CANUTO 05DEC2002
 APVD A. GENIA 05DEC2002

PRODUCT SPEC 108-20254
 APPLICATION SPEC 411-20067
 WEIGHT -

CUSTOMER DRAWING

SCALE 3:1 SHEET 8 OF 11 REV B36

NAME CAVITY MASK FOR 94 POS. CONNECTOR (COPERCHIO CAVITA' PER CONNETTORE 94 POSIZIONI)

SIZE A2 CAGE CODE 00779 DRAWING NO C-284871 RESTRICTED TO

TE Connectivity

LOC		DIST		REVISIONS			
P	LTR	DESCRIPTION	DATE	DWN	APVD		
-	-	SEE SHEET 1	-	-	-		

P/N 4-284871-6 BLACK AS SHOWN

△ POLYAMIDE 6.6 GLASS FILLED BLACK COLOUR
 PA 66 CARICATO VETRO COLORE NERO

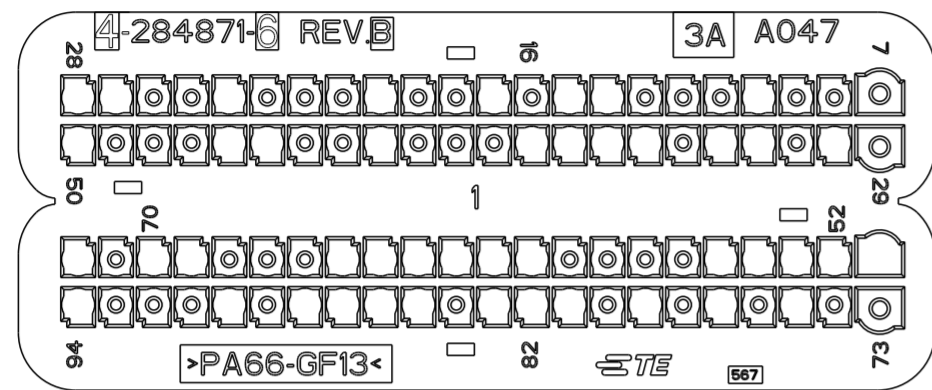

POSITION OPEN CAVITIES
(POSIZIONE CAVITA' APERTE)

10, 14, 15, 17, 20, 24, 27, 28, 30, 32, 33, 35, 36, 37, 38, 42, 45, 46, 50, 51, 52, 53, 54, 55, 60, 61, 62, 63, 64, 65, 69, 70, 72, 75, 77, 79, 81, 82, 83, 85, 86, 87, 88, 90, 94
--

POSITION CLOSED CAVITIES
(POSIZIONE CAVITA' CHIUSE)

7, 8, 9, 11, 12, 13, 16, 18, 19, 21, 22, 23, 25, 26, 29, 31, 34, 39, 40, 41, 43, 44, 47, 48, 49, 56, 57, 58, 59, 66, 67, 68, 71, 73, 74, 76, 78, 80, 84, 89, 91, 92, 93

P/N 4-284871-7 GREY AS SHOWN

△ POLYAMIDE 6.6 GLASS FILLED GREY COLOUR
 PA 66 CARICATO VETRO COLORE GRIGIO

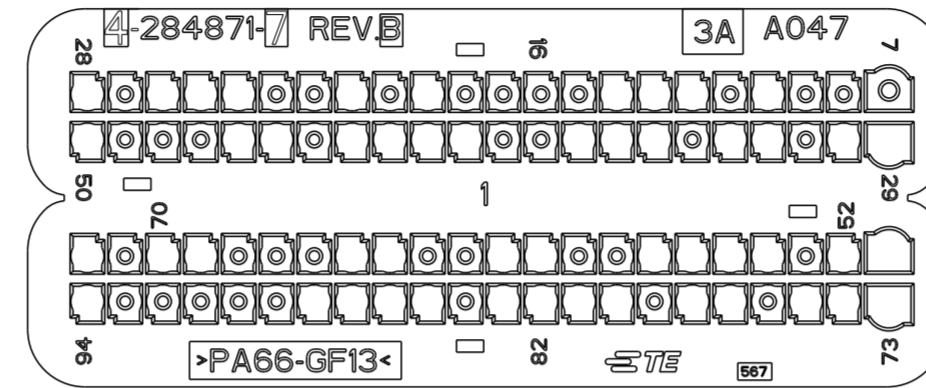

POSITION OPEN CAVITIES
(POSIZIONE CAVITA' APERTE)

10, 12, 13, 14, 19, 21, 24, 25, 26, 28, 29, 30, 32, 33, 35, 36, 37, 40, 41, 42, 43, 45, 46, 50, 51, 52, 54, 55, 56, 57, 60, 61, 64, 65, 69, 70, 72, 73, 74, 75, 77, 78, 80, 81, 82, 83, 85, 86, 87, 88, 94
--

POSITION CLOSED CAVITIES
(POSIZIONE CAVITA' CHIUSE)

7, 8, 9, 11, 15, 16, 17, 18, 20, 22, 23, 27, 31, 34, 38, 39, 44, 47, 48, 49, 53, 58, 59, 62, 63, 66, 67, 68, 71, 76, 79, 84, 89, 90, 91, 92, 93

P/N 4-284871-8 BROWN AS SHOWN

△ POLYAMIDE 6.6 GLASS FILLED BROWN COLOUR
 PA 66 CARICATO VETRO COLORE MARRONE

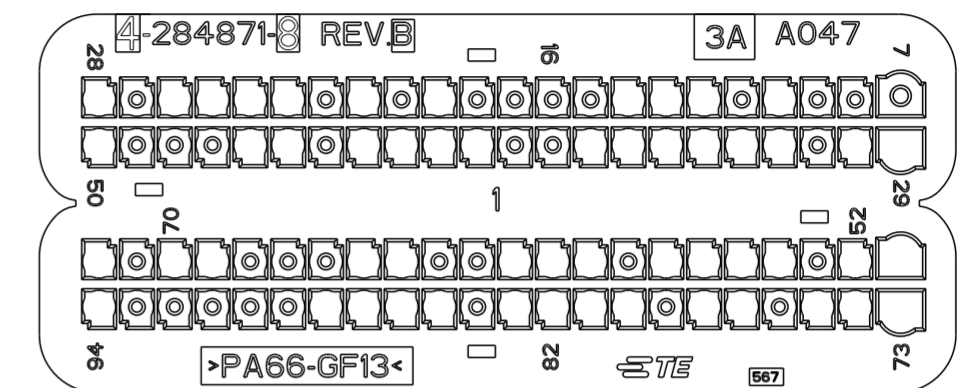

POSITION OPEN CAVITIES
(POSIZIONE CAVITA' APERTE)

10, 12, 13, 14, 19, 21, 23, 24, 25, 26, 28, 29, 30, 32, 33, 34, 35, 36, 37, 40, 41, 42, 43, 45, 46, 50, 51, 52, 54, 55, 56, 57, 59, 60, 61, 64, 65, 69, 70, 72, 73, 74, 75, 77, 78, 80, 81, 82, 83, 85, 86, 87, 88, 94
--

POSITION CLOSED CAVITIES
(POSIZIONE CAVITA' CHIUSE)

7, 8, 9, 11, 15, 16, 17, 18, 20, 22, 27, 31, 38, 39, 44, 47, 48, 49, 53, 58, 62, 63, 66, 67, 68, 71, 76, 79, 84, 89, 90, 91, 92, 93

~~OBSOLETE~~ P/N 4-284871-9 GREEN AS SHOWN

△ POLYAMIDE 6.6 GLASS FILLED GREEN COLOUR
 PA 66 CARICATO VETRO COLORE VERDE

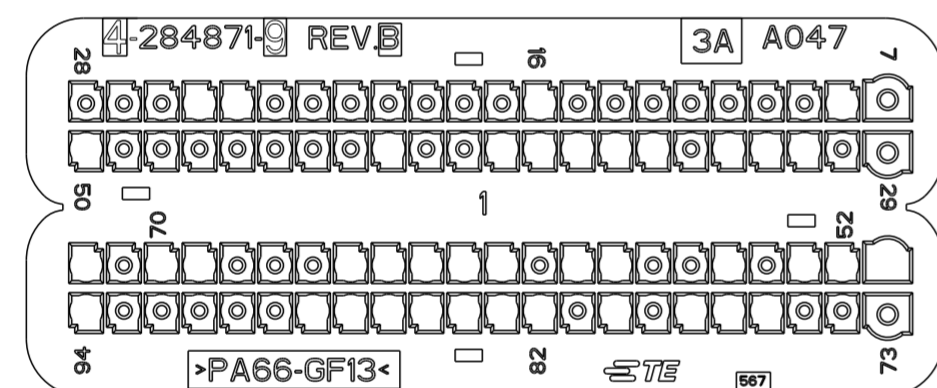

POSITION OPEN CAVITIES
(POSIZIONE CAVITA' APERTE)

8, 16, 24, 25, 31, 32, 33, 35, 36, 37, 38, 39, 42, 50, 51, 52, 53, 55, 58, 59, 61, 62, 63, 64, 65, 69, 70, 72, 76, 77, 78, 80, 82, 83, 84, 85, 86, 87, 88, 94

POSITION CLOSED CAVITIES
(POSIZIONE CAVITA' CHIUSE)

7, 9, 10, 11, 12, 13, 14, 15, 17, 18, 19, 20, 21, 22, 23, 26, 27, 28, 29, 30, 34, 40, 41, 43, 44, 45, 46, 47, 48, 49, 54, 56, 57, 60, 66, 67, 68, 71, 73, 74, 75, 79, 81, 89, 90, 91, 92, 93
--

P/N 5-284871-0 BLUE AS SHOWN

△ POLYAMIDE 6.6 GLASS FILLED BLUE COLOUR
 PA 66 CARICATO VETRO COLORE BLU

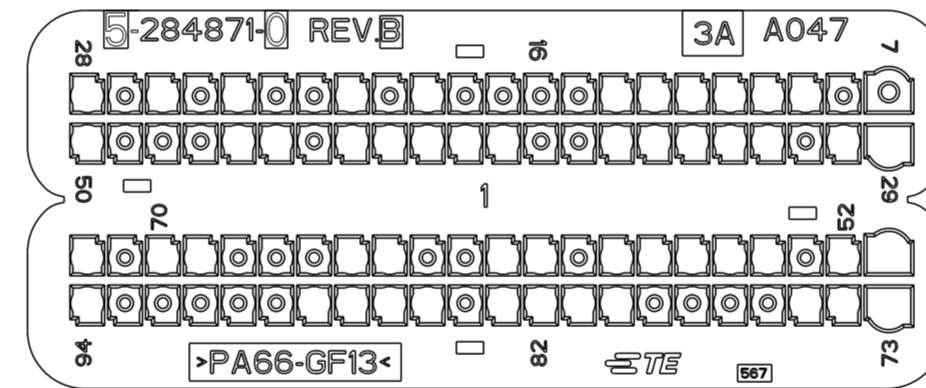

POSITION OPEN CAVITIES
(POSIZIONE CAVITA' APERTE)

9, 10, 11, 12, 13, 14, 19, 21, 24, 26, 28, 29, 30, 32, 33, 34, 35, 36, 39, 40, 41, 42, 43, 45, 46, 50, 51, 52, 54, 55, 56, 57, 58, 60, 61, 64, 65, 69, 70, 72, 73, 74, 75, 80, 81, 82, 83, 85, 86, 87, 88, 94

POSITION CLOSED CAVITIES
(POSIZIONE CAVITA' CHIUSE)

7, 8, 15, 16, 17, 18, 20, 22, 23, 25, 27, 31, 37, 38, 44, 47, 48, 49, 53, 59, 62, 63, 66, 67, 68, 71, 76, 77, 78, 79, 84, 89, 90, 91, 92, 93
--

P/N 5-284871-1 BLACK AS SHOWN

△ POLYAMIDE 6.6 GLASS FILLED BLACK COLOUR
 PA 66 CARICATO VETRO COLORE NERO

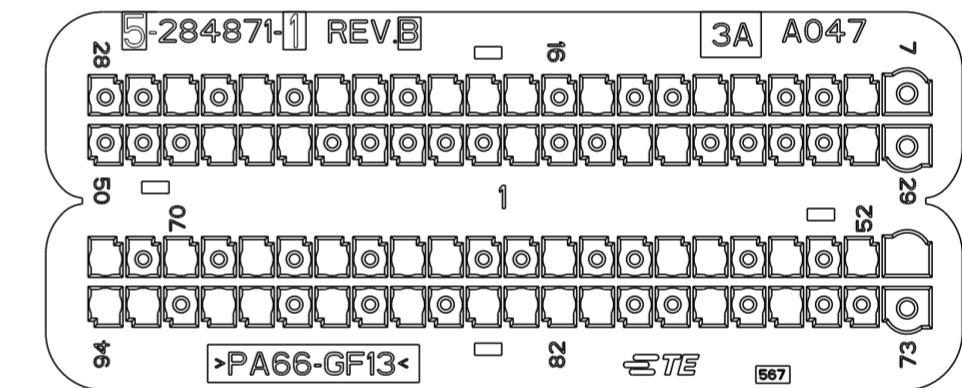

POSITION OPEN CAVITIES
(POSIZIONE CAVITA' APERTE)

8, 11, 12, 15, 17, 18, 19, 22, 24, 26, 30, 35, 36, 39, 45, 46, 47, 51, 52, 54, 56, 57, 60, 63, 64, 66, 68, 70, 72, 76, 78, 81, 82, 83, 84, 86, 88, 90, 91, 93, 94

POSITION CLOSED CAVITIES
(POSIZIONE CAVITA' CHIUSE)

7, 9, 10, 13, 14, 16, 20, 21, 23, 25, 27, 28, 29, 31, 32, 33, 34, 37, 38, 40, 41, 42, 43, 44, 48, 49, 50, 53, 55, 58, 59, 61, 62, 65, 67, 69, 71, 73, 74, 75, 77, 79, 80, 85, 87, 89, 92
--

CAVITY MASK APPLICATIONS (APPLICAZIONE COPERCHIO CAVITA')

P/N	4-284871-6	4-284871-7	4-284871-8	4-284871-9	5-284871-0	5-284871-1
	900 E6 ENGINE:	1.3 SDE E5+ ENGINE:				
APPLICATION (APPLICAZIONE)	139 BZ-CNG 846 BZ-CNG 330 BZ-CNG 312 BZ 199 BZ 955 BZ	139 846 330 312 199 955	263 1.3 E5 & E5+	MY 2014 - F500	DUCATO FL 2014 GSX/GDX FIA	DUCATO FL 2014 GSX/GDX FIC

THIS DRAWING IS A CONTROLLED DOCUMENT FOR TYCO ELECTRONICS CORPORATION. IT IS SUBJECT TO CHANGE AND THE CONTROLLING ENGINEERING ORGANIZATION SHOULD BE CONTACTED FOR THE LATEST REVISION.

DIMENSIONS: mm

TOLERANCES UNLESS OTHERWISE SPECIFIED:

0 PLC	±0.3
1 PLC	±0.3
2 PLC	±0.2
3 PLC	±
4 PLC	±
ANGLES	±1°
FINISH	

MATERIAL

DWN: 05DEC2002
 M. POLIZZINI
 CHK: 05DEC2002
 O. CANUO
 APVD: 05DEC2002
 A. GENIA

PRODUCT SPEC: 108-20254
 APPLICATION SPEC: 411-20067

WEIGHT: -

CUSTOMER DRAWING

SCALE: 3:1

SHEET 9 OF 11

REV: B36

NAME: CAVITY MASK FOR 94 POS. CONNECTOR (COPERCHIO CAVITA' PER CONNETTORE 94 POSIZIONI)

SIZE: A2

CAGE CODE: 00779

DRAWING NO: C-284871

RESTRICTED TO: -

LOC		DIST		REVISIONS			
P	LTR	DESCRIPTION	DATE	DWN	APVD		
-	-	SEE SHEET 1	-	-	-		

P/N 5-284871-2 GREY AS SHOWN

⚠ POLYAMIDE 6.6 GLASS FILLED GREY COLOUR
 PA 66 CARICATO VETRO COLORE GRIGIO

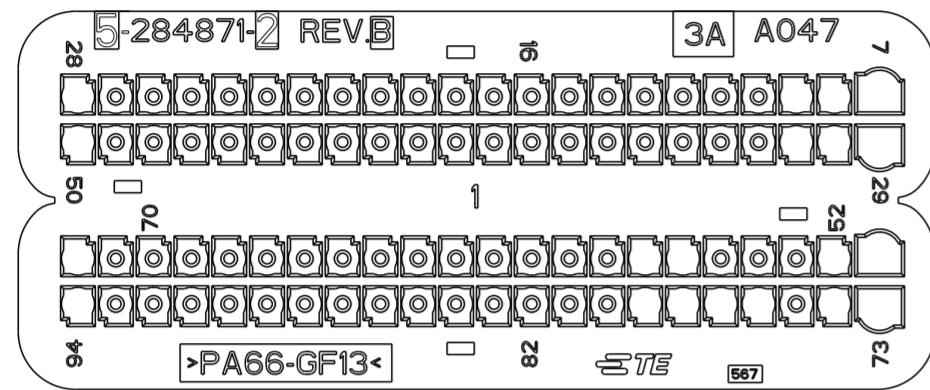

POSITION OPEN CAVITIES
(POSIZIONE CAVITA' APERTE)

7, 8, 9, 28, 29, 30, 31, 50, 51, 52, 56, 57, 72, 73, 74, 76, 77, 78, 79, 94

POSITION CLOSED CAVITIES
(POSIZIONE CAVITA' CHIUSE)

10, 11, 12, 13, 14, 15, 16, 17, 18, 19, 20, 21, 22, 23, 24, 25, 26, 27, 32, 33, 34, 35, 36, 37, 38, 39, 40, 41, 42, 43, 44, 45, 46, 47, 48, 49, 53, 54, 55, 58, 59, 60, 61, 62, 63, 64, 65, 66, 67, 68, 69, 70, 71, 75, 80, 81, 82, 83, 84, 85, 86, 87, 88, 89, 90, 91, 92, 93
--

POSITION OPEN CAVITIES
(POSIZIONE CAVITA' APERTE)

7, 8, 9, 28, 29, 30, 31, 51, 52, 56, 57, 72, 73, 74, 76, 77, 78, 79

POSITION CLOSED CAVITIES
(POSIZIONE CAVITA' CHIUSE)

10, 11, 12, 13, 14, 15, 16, 17, 18, 19, 20, 21, 22, 23, 24, 25, 26, 27, 32, 33, 34, 35, 36, 37, 38, 39, 40, 41, 42, 43, 44, 45, 46, 47, 48, 49, 50, 53, 54, 55, 58, 59, 60, 61, 62, 63, 64, 65, 66, 67, 68, 69, 70, 71, 75, 80, 81, 82, 83, 84, 85, 86, 87, 88, 89, 90, 91, 92, 93, 94
--

P/N 5-284871-3 BROWN AS SHOWN

⚠ POLYAMIDE 6.6 GLASS FILLED BROWN COLOUR
 PA 66 CARICATO VETRO COLORE MARRONE

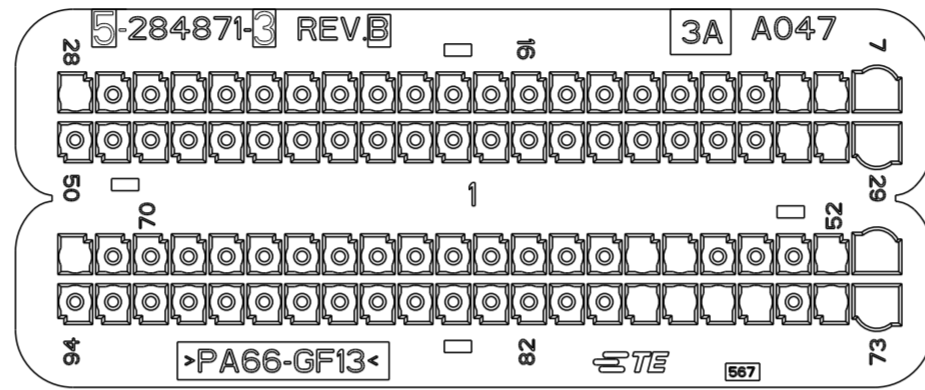

P/N 5-284871-4 GREEN AS SHOWN

⚠ POLYAMIDE 6.6 GLASS FILLED GREEN COLOUR
 PA 66 CARICATO VETRO COLORE VERDE

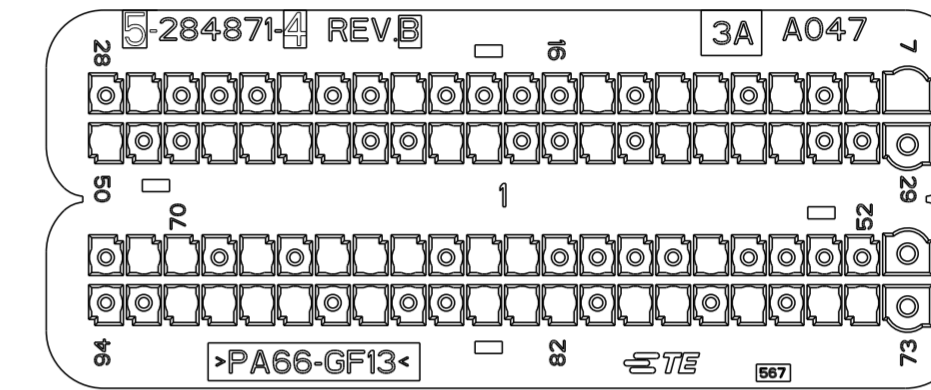

VERSION NOT IN PRODUCTION

POSITION OPEN CAVITIES

7, 8, 10, 12, 13, 15, 20, 23, 27, 32, 33, 34, 35, 37, 40, 41, 44, 45, 46, 47, 50, 56, 61, 62, 64, 65, 66, 68, 70, 71, 74, 75, 77, 79, 80, 82, 83, 84, 87, 89, 90, 91, 92
--

POSITION CLOSED CAVITIES

9, 11, 14, 16, 17, 18, 19, 21, 22, 24, 25, 26, 28, 29, 30, 31, 36, 38, 39, 42, 43, 48, 49, 51, 52, 53, 54, 55, 57, 58, 59, 60, 63, 67, 69, 72, 73, 76, 78, 81, 85, 86, 88, 93, 94

P/N 5-284871-5 BLUE AS SHOWN

⚠ POLYAMIDE 6.6 GLASS FILLED BLUE COLOUR
 PA 66 CARICATO VETRO COLORE BLU

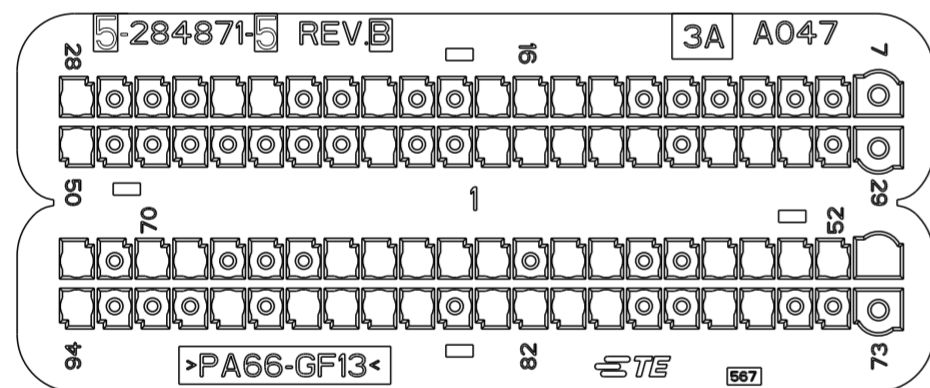

POSITION OPEN CAVITIES
(POSIZIONE CAVITA' APERTE)

14, 15, 16, 17, 20, 23, 24, 28, 31, 32, 33, 35, 36, 37, 38, 39, 42, 50, 51, 52, 53, 54, 55, 58, 59, 61, 62, 63, 64, 65, 69, 70, 72, 76, 77, 80, 81, 82, 83, 85, 86, 87, 88, 90, 94.

POSITION CLOSED CAVITIES
(POSIZIONE CAVITA' CHIUSE)

7, 8, 9, 10, 11, 12, 13, 18, 19, 21, 22, 25, 26, 27, 29, 30, 34, 40, 41, 43, 44, 45, 46, 47, 48, 49, 56, 57, 60, 66, 67, 68, 71, 73, 74, 75, 78, 79, 84, 89, 91, 92, 93.
--

POSITION OPEN CAVITIES
(POSIZIONE CAVITA' APERTE)

15, 16, 17, 20, 24, 28, 33, 35, 36, 37, 38, 39, 42, 50, 51, 52, 53, 55, 60, 61, 62, 63, 64, 65, 69, 70, 72, 75, 77, 81, 82, 83, 85, 86, 87, 88, 90, 94.

POSITION CLOSED CAVITIES
(POSIZIONE CAVITA' CHIUSE)

7, 8, 9, 10, 11, 12, 13, 14, 18, 19, 21, 22, 23, 25, 26, 27, 29, 30, 31, 32, 34, 40, 41, 43, 44, 45, 46, 47, 48, 49, 54, 56, 57, 58, 59, 66, 67, 68, 71, 73, 74, 76, 78, 79, 80, 84, 89, 91, 92, 93.
--

P/N 5-284871-6 BLACK AS SHOWN

⚠ POLYAMIDE 6.6 GLASS FILLED BLACK COLOUR
 PA 66 CARICATO VETRO COLORE NERO

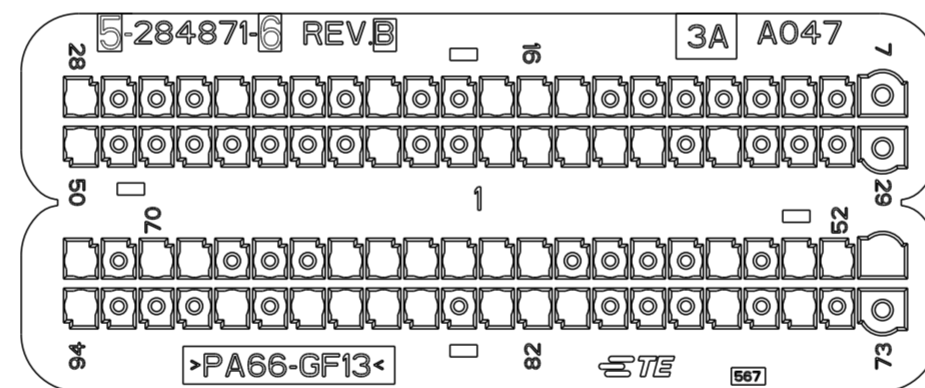

P/N 5-284871-7 GREY AS SHOWN

⚠ POLYAMIDE 6.6 GLASS FILLED GREY COLOUR
 PA 66 CARICATO VETRO COLORE GRIGIO

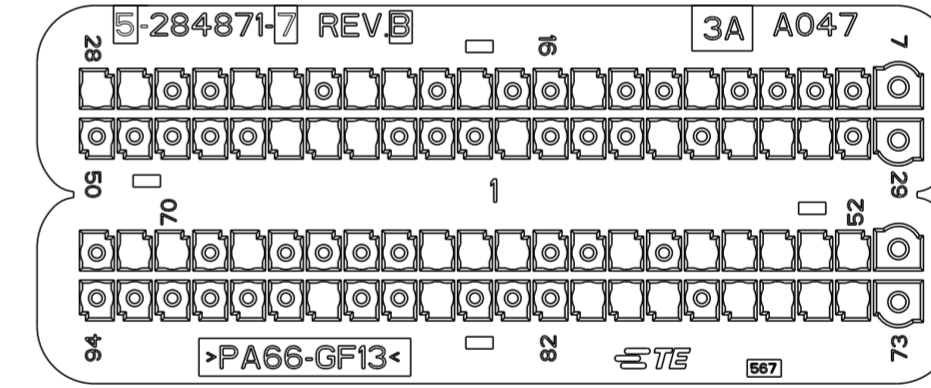

POSITION OPEN CAVITIES
(POSIZIONE CAVITA' APERTE)

12, 15, 18, 20, 21, 23, 24, 27, 28, 31, 32, 33, 35, 39, 43, 44, 45, 52, 53, 54, 55, 56, 58, 61, 62, 63, 68, 70, 71, 74, 75, 76, 77, 79, 80, 81, 85, 88
--

POSITION CLOSED CAVITIES
(POSIZIONE CAVITA' CHIUSE)

7, 8, 9, 10, 11, 13, 14, 16, 17, 19, 22, 25, 26, 29, 30, 34, 36, 37, 38, 40, 41, 42, 46, 47, 48, 49, 50, 51, 57, 59, 60, 64, 65, 66, 67, 69, 72, 73, 78, 82, 83, 84, 86, 87, 89, 90, 91, 92, 93, 94

CAVITY MASK APPLICATIONS (APPLICAZIONE COPERCHIO CAVITA')

P/N	5-284871-2	5-284871-3	5-284871-4 (NOT IN PRODUCTION)	5-284871-5
APPLICATION (APPLICAZIONE)	520 - AWD 334 - AWD	MP - AWD	YP8 YL8 YBA YLI YAD	500X_1.4cc benzina_MY2017

THIS DRAWING IS A CONTROLLED DOCUMENT FOR TYCO ELECTRONICS CORPORATION
 IT IS SUBJECT TO CHANGE AND THE CONTROLLING ENGINEERING ORGANIZATION
 SHOULD BE CONTACTED FOR THE LATEST REVISION.

DIMENSIONS: mm

TOLERANCES UNLESS OTHERWISE SPECIFIED:

0 PLC	±0.3
1 PLC	±0.3
2 PLC	±0.2
3 PLC	±
4 PLC	±
ANGLES	±1°
FINISH	

MATERIAL

DWN: 05DEC2002
 M. POLIZZI
 CHK: 05DEC2002
 O. CANUTO
 APVD: 05DEC2002
 A. GENIA

TE Connectivity

NAME: CAVITY MASK FOR 94 POS. CONNECTOR
(COPERCHIO CAVITA' PER CONNETTORE 94 POSIZIONI)

PRODUCT SPEC: 108-20254
 APPLICATION SPEC: 411-20067

SIZE: A2 CAGE CODE: 00779 DRAWING NO: C-284871 RESTRICTED TO: -

WEIGHT: -

CUSTOMER DRAWING SCALE: 3:1 SHEET 10 OF 11 REV: B36

THIS DRAWING IS UNPUBLISHED. RELEASED FOR PUBLICATION 2002
 © COPYRIGHT 2002 BY TYCO ELECTRONICS CORPORATION. ALL RIGHTS RESERVED.

LOC		DIST		REVISIONS			
P	LTR	DESCRIPTION	DATE	DWN	APVD		
-	-	SEE SHEET 1	-	-	-		

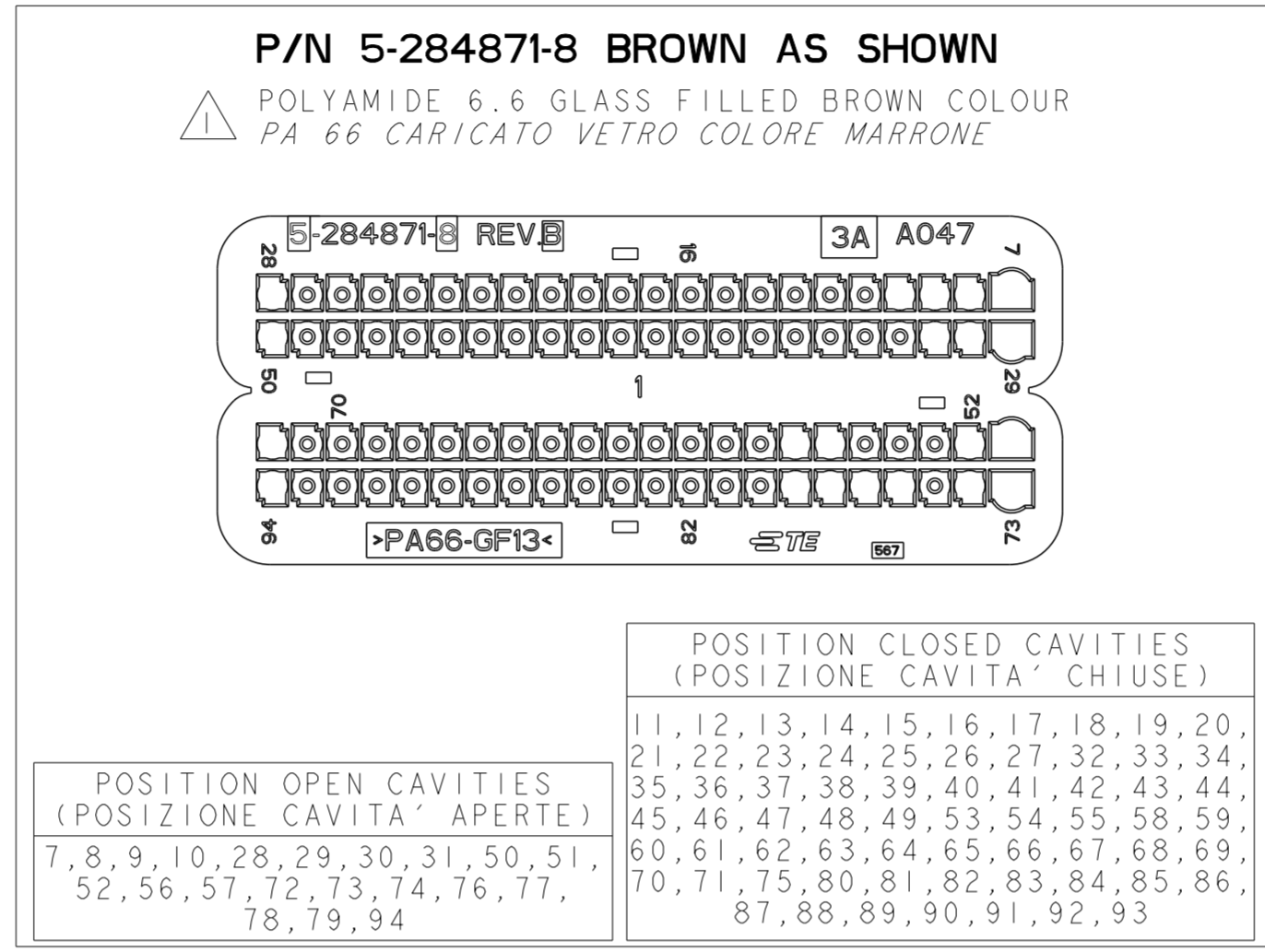

CAVITY MASK APPLICATIONS (APPLICAZIONE COPERCHIO CAVITA')					
P/N					
APPLICATION (APPLICAZIONE)					

THIS DRAWING IS A CONTROLLED DOCUMENT FOR TYCO ELECTRONICS CORPORATION
 IT IS SUBJECT TO CHANGE AND THE CONTROLLING ENGINEERING ORGANIZATION
 SHOULD BE CONTACTED FOR THE LATEST REVISION.

DWN	M. POLIZZI	05DEC2002
CHK	O. CANUTO	05DEC2002
APVD	A. GENIA	05DEC2002
PRODUCT SPEC	108-20254	
APPLICATION SPEC	411-20067	
WEIGHT	-	
CUSTOMER DRAWING		

NAME	CAVITY MASK FOR 94 POS. CONNECTOR (COPERCHIO CAVITA' PER CONNETTORE 94 POSIZIONI)		
SIZE	CAGE CODE	DRAWING NO	RESTRICTED TO
A2	00779	C-284871	-
SCALE	3:1	SHEET	11 OF 11 REV B36