

P	LTR	DESCRIPTION	DATE	DWN	APVD
	F4	PN 1-282884-1 RELEASED FOR PRODUCTION	20SEP2018	RK	PS
	F5	PART STATUS UPDATED	20OCT2021	SCB	SS

CLAMPING SCREW TEST FACILITY

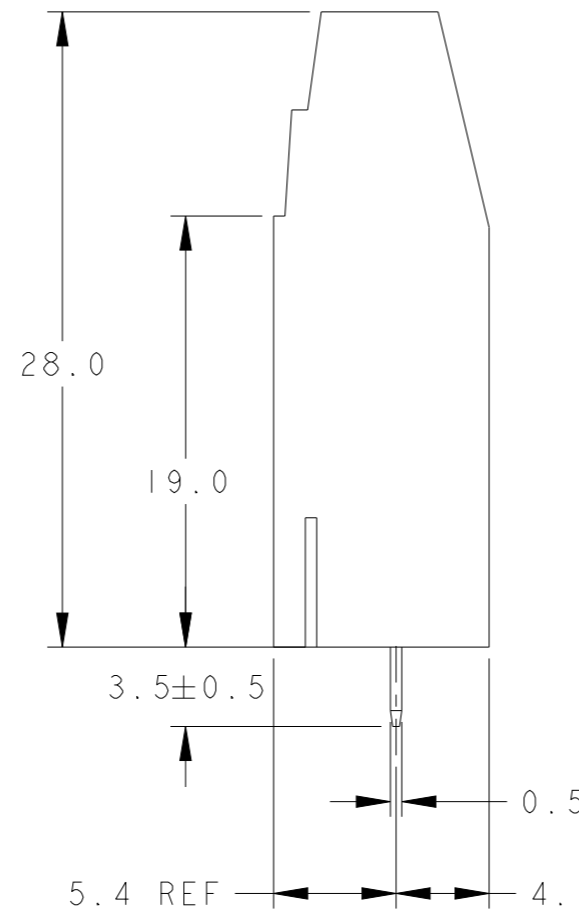

OBSOLETE	-	50.0	10	1-282884-7
	-	45.0	9	1-282884-6
	-	40.0	8	1-282884-5
	-	30.0	6	1-282884-4
	SEE SHEET 2	15.0	3	1-282884-3
	-	40.0	8	1-282884-2
OBSOLETE	SEE SHEET 2	15.0	3	1-282884-1
	SEE SHEET 2	50.0	10	1-282884-0
	SEE SHEET 2	40.0	8	282884-9
	SEE SHEET 2	10.0	2	282884-8
	SEE SHEET 2	10.0	2	282884-7
	SEE SHEET 2	15.0	3	282884-6
	SEE SHEET 2	15.0	3	282884-5
	SEE SHEET 2	10.0	2	282884-4
-	15.0	3	282884-3	
-	10.0	2	282884-2	
MARKING		DIM. A	No POS.	PART NUMBER

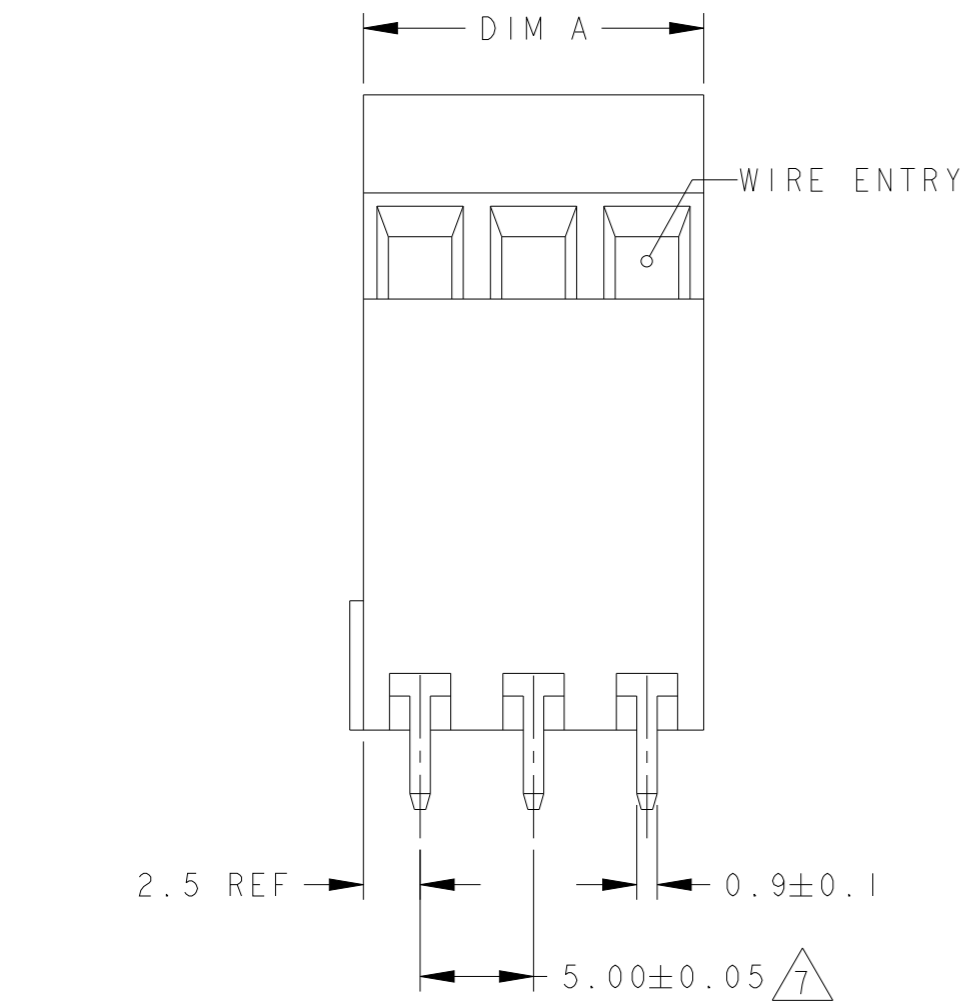
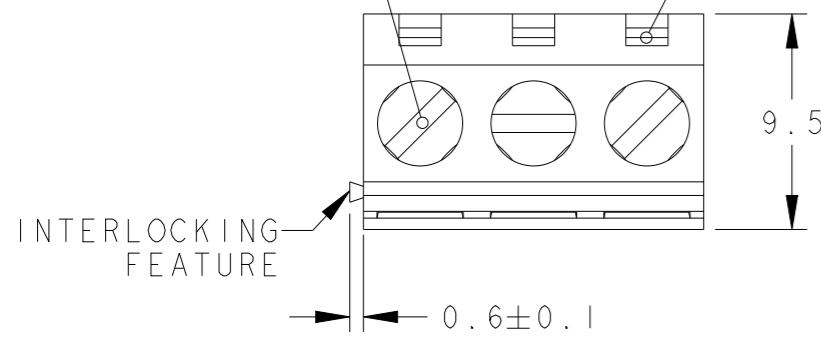
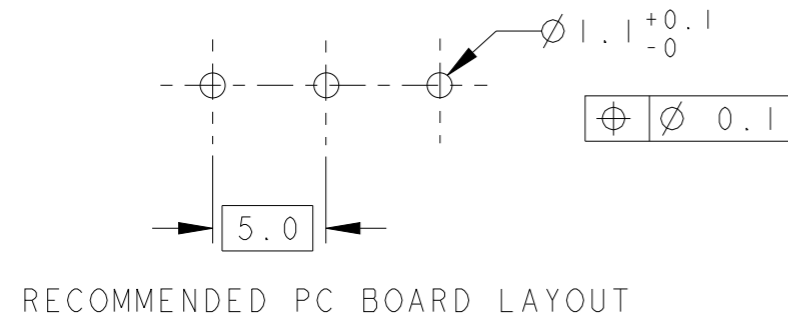

RECOMMENDED PC BOARD LAYOUT

THIS DRAWING IS A CONTROLLED DOCUMENT.

DWN E. ZANOLINI 02NOV2001
 CHK D. BIEVENOUR 02NOV2001
 APVD D. BIEVENOUR 02NOV2001

STE TE Connectivity

NAME: TERMINAL BLOCK, PCB MOUNT
 3RD LEVEL
 STACKING W/ INTERLOCK, 5 mm PITCH

PRODUCT SPEC: 108-21066
 APPLICATION SPEC: 114-20079

SIZE: A3 CAGE CODE: 300779 DRAWING NO: C-282884 RESTRICTED TO: -

MATERIAL: SEE NOTES FINISH: SEE NOTES WEIGHT: -

CUSTOMER DRAWING SCALE: 3:1 SHEET: 1 OF 3 REV: F5

P	LTR	DESCRIPTION	DATE	DWN	APVD
	-	SEE SHEET 1	-	-	-



282884-4 AS SHOWN

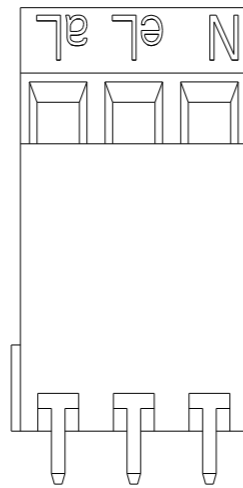

282884-5 AS SHOWN

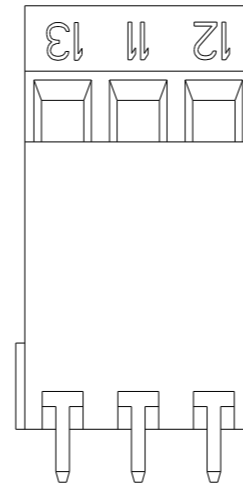

282884-6 AS SHOWN

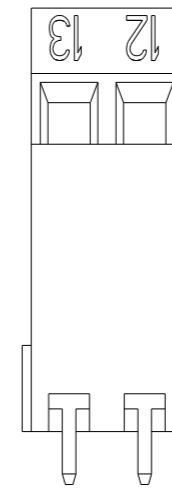

282884-7 AS SHOWN

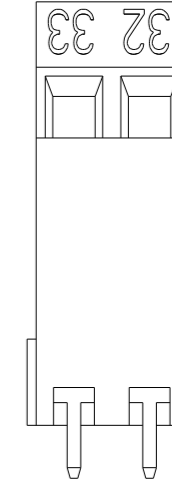

282884-8 AS SHOWN

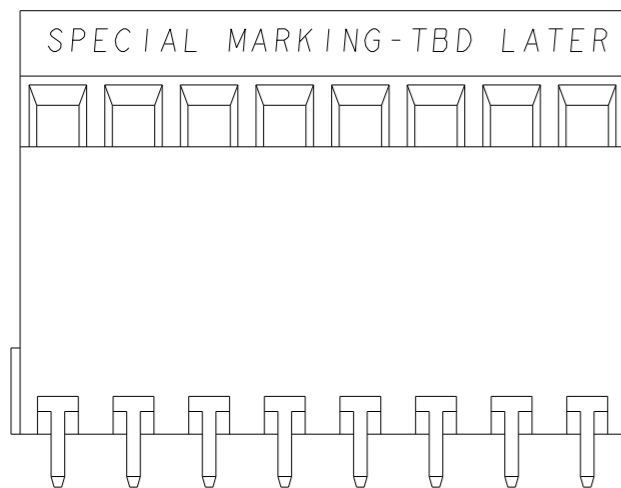

~~282884-9~~ AS SHOWN
OBSOLETE

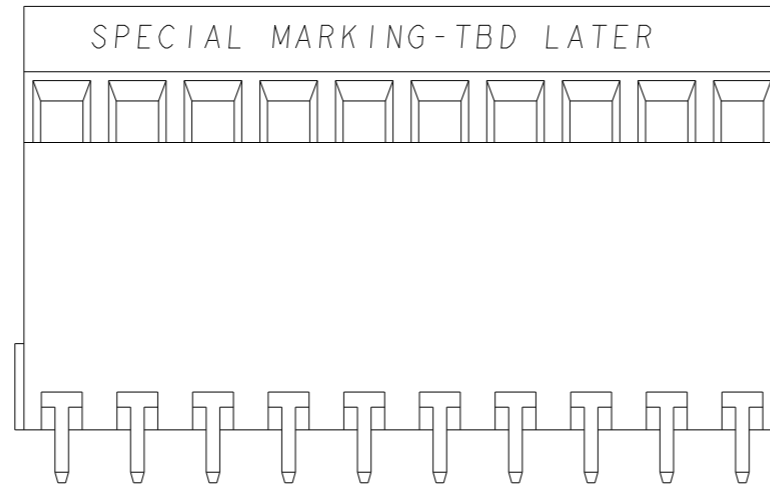

~~282884-0~~ AS SHOWN
OBSOLETE

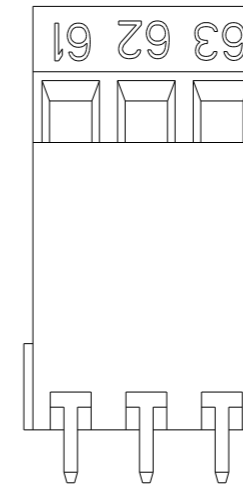

282884-1 AS SHOWN

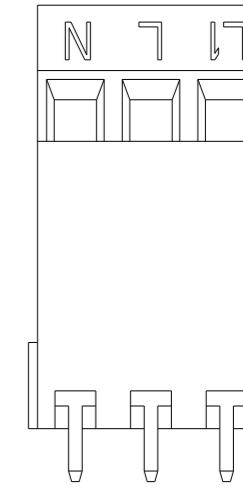

~~282884-3~~ AS SHOWN
OBSOLETE



THIS DRAWING IS A CONTROLLED DOCUMENT.

DIMENSIONS:
mm

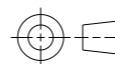

TOLERANCES UNLESS OTHERWISE SPECIFIED:

- 0 PLC ±0.3
- 1 PLC ±0.25
- 2 PLC ±0.25
- 3 PLC ±0.25
- 4 PLC ±0.25
- ANGLES ±2°
- FINISH SEE NOTES

MATERIAL
SEE NOTES

DWN 02NOV2001
E. ZANOLINI

CHK 02NOV2001
D. BIEVENOUR

APVD 02NOV2001
D. BIEVENOUR

PRODUCT SPEC
108-21066

APPLICATION SPEC
114-20079

WEIGHT
-

CUSTOMER DRAWING



NAME
TERMINAL BLOCK, PCB MOUNT
3RD LEVEL
STACKING W/ INTERLOCK, 5 mm PITCH

SIZE	CAGE CODE	DRAWING NO	RESTRICTED TO
A3	00779	C-282884	-

SCALE 3:1 SHEET 2 OF 3 REV F5

REVISIONS

P	LTR	DESCRIPTION	DATE	DWN	APVD
	-	SEE SHEET 1	-	-	-

1. MATERIALS AND FINISH
HOUSING: PA 6-6, UL 94-V0, COLOR GREEN.
CLAMP: BRASS, NICKEL PLATED.
TERMINAL: BRASS, TIN PLATED.
CLAMPING SCREW: M3, BRASS, NICKEL PLATED.
 2. MECHANICAL
MIN. PC BOARD HOLES DIAMETER : 1.1 mm
MAX. PC BOARD THICKNESS : 2.4 mm
WIRE STRIPPING LENGTH : 5.0-6.0 mm
RECOMMENDED TIGHTENING TORQUE FOR SCREW : 0.5 Nm.
 3. ELECTRICAL
WIRE RANGE : 16-30 AWG
MAX. VOLTAGE : 300 V
MAX. CURRENT : 13.5 A
CONTACT RESISTANCE : <15 m Ohm
INSULATION RESISTANCE : >1000 M Ohm (500V DC)
 4. END-TO-END STACKABLE W/INTERLOCK WITHOUT LOSS OF CENTERLINE SPACING.
 5. RECOGNIZED UNDER THE COMPONENT PROGRAM OF UNDERWRITERS LABORATORIES INC., FILE NO E60677.
 6. OPERATING TEMPERATURE RANGE: -40°C TO +110°C
- 7 NOT CUMULATIVE TOLERANCE.
 - 8 INK MARKING, BLACK COLOR
 - 9 PART NUMBER IS OBTAINED BY ASSEMBLYING AND GLUING TOGETHER No.4 CONNECTORS P/N 282884-2
 - 10 PART NUMBER IS OBTAINED BY ASSEMBLYING AND GLUING TOGETHER No.5 CONNECTORS P/N 282884-2

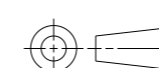
THIS DRAWING IS A CONTROLLED DOCUMENT.		DWN E. ZANOLINI 02NOV2001															
DIMENSIONS: mm		CHK D. BIEVENOUR 02NOV2001															
TOLERANCES UNLESS OTHERWISE SPECIFIED:		APVD D. BIEVENOUR 02NOV2001	NAME TERMINAL BLOCK, PCB MOUNT 3RD LEVEL STACKING W/ INTERLOCK, 5 mm PITCH														
		PRODUCT SPEC 108-21066	RESTRICTED TO														
<table border="0"> <tr><td>0 PLC</td><td>±°</td></tr> <tr><td>1 PLC</td><td>±0.3</td></tr> <tr><td>2 PLC</td><td>±0.25</td></tr> <tr><td>3 PLC</td><td>±°</td></tr> <tr><td>4 PLC</td><td>±°</td></tr> <tr><td>ANGLES</td><td>±2°</td></tr> </table>		0 PLC	±°	1 PLC	±0.3	2 PLC	±0.25	3 PLC	±°	4 PLC	±°	ANGLES	±2°	APPLICATION SPEC 114-20079	SIZE A3	CAGE CODE 00779	DRAWING NO C-282884
0 PLC	±°																
1 PLC	±0.3																
2 PLC	±0.25																
3 PLC	±°																
4 PLC	±°																
ANGLES	±2°																
MATERIAL SEE NOTES	FINISH SEE NOTES	WEIGHT -	-														
		CUSTOMER DRAWING	SCALE 3:1	SHEET 3 OF 3	REV F5												