

P	LTR	DESCRIPTION	DATE	DWN	APVD
A		RELEASE TO PRODUCTION	22FEB2022	AY	PS

NOTES:

1. MATERIAL:
LCP BLACK, UL94 V0
2. N = NUMBER OF POSITION PER HOUSING.
3. HOUSING TO BE USED WITH CRIMP CONTACTS
2316113 (AWG 28-24/0.08-0.22 mm²) AND
2316114 (AWG 30-28/0.05-0.08 mm²)
4. PACKAGING : BULK BOX
TUBE PACKAGING IS ON REQUEST ONLY

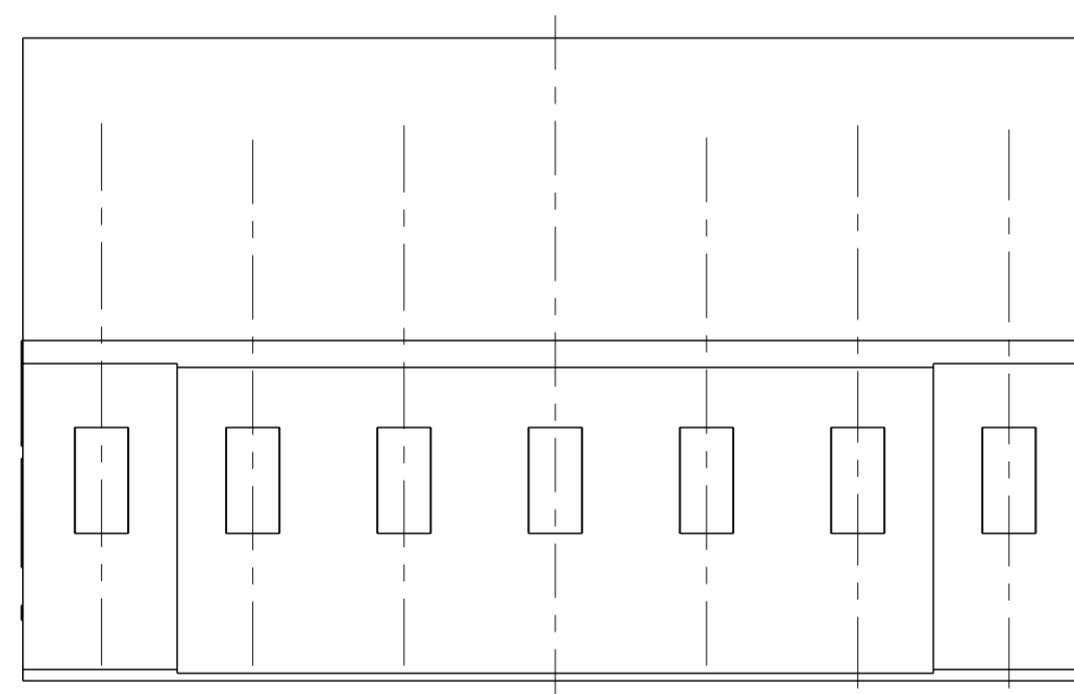
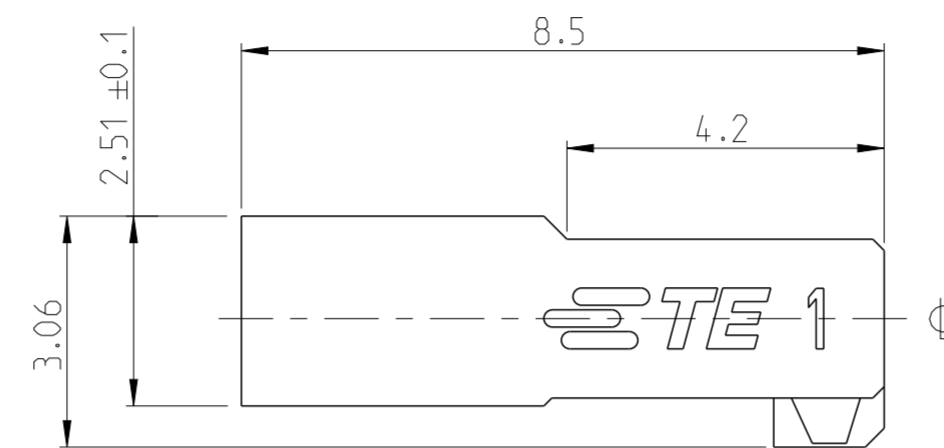
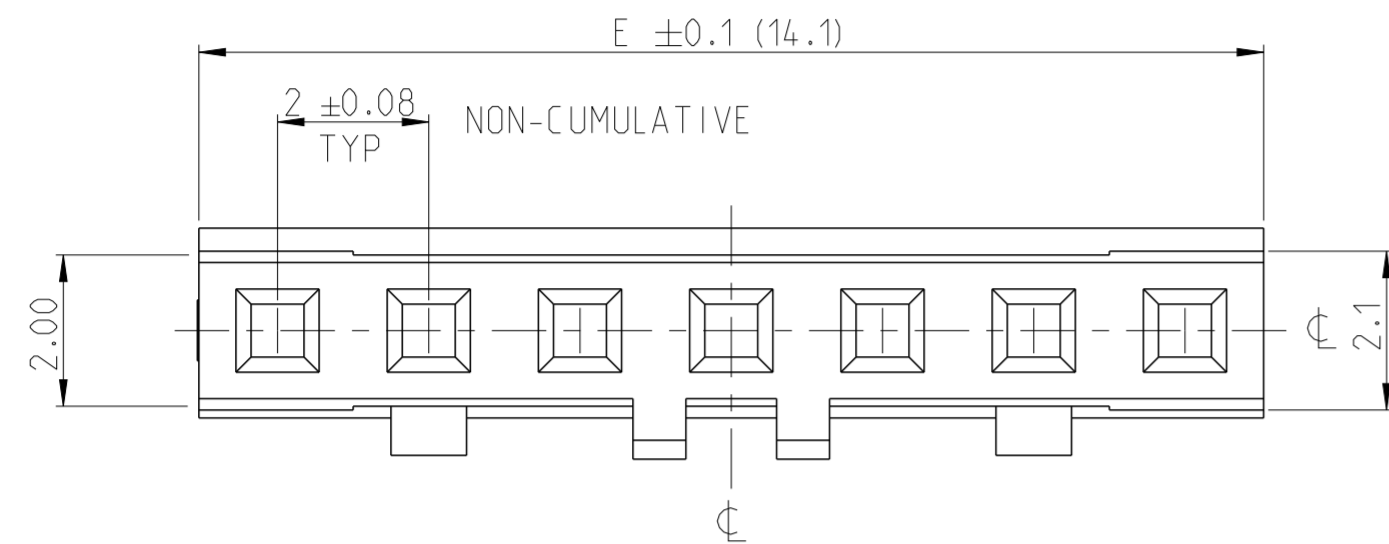

CENTERLINE FOR ODD AND EVEN POSITION HOUSINGS

SCALE 5:1

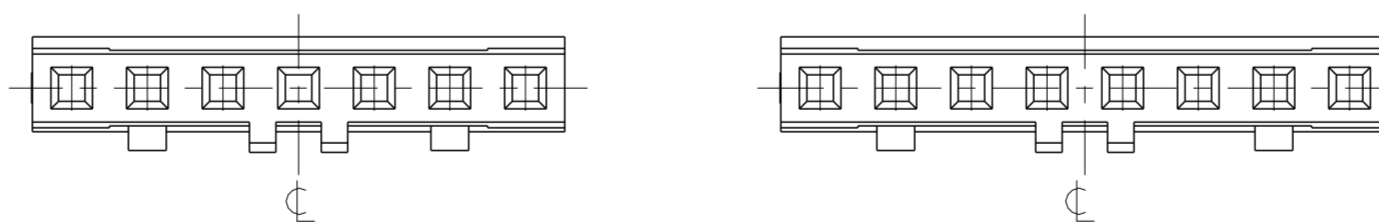

SINGLE ROW HOUSING,
POLARIZED W/ LOCKING
RAMP VERSION

-7 AS SHOWN

6:1

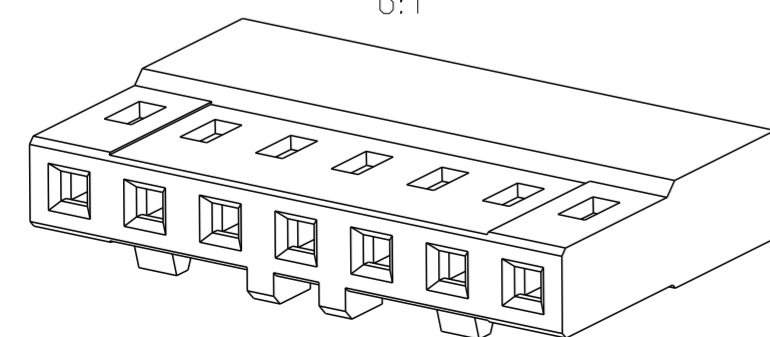

32.1	16	2MM-RCD-S16-BX
30.1	15	2MM-RCD-S15-BX
28.1	14	2MM-RCD-S14-BX
26.1	13	2MM-RCD-S13-BX
24.1	12	2MM-RCD-S12-BX
22.1	11	2MM-RCD-S11-BX
20.1	10	2MM-RCD-S10-BX
18.1	9	2MM-RCD-S09-BX
16.1	8	2MM-RCD-S08-BX
14.1	7	2MM-RCD-S07-BX
DIM "E"	N	SMART PN

THIS DRAWING IS A CONTROLLED DOCUMENT.

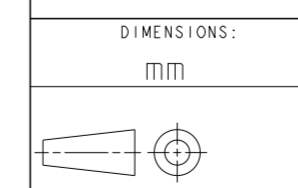

MATERIAL
SEE NOTE 1

DIMENSIONS:		TOLERANCES UNLESS OTHERWISE SPECIFIED:	
mm			
0 PLC	±		
1 PLC	±0.15		
2 PLC	±0.10		
3 PLC	±		
4 PLC	±		
ANGLES	±2°		
FINISH	-		

DWN 29OCT2016
RAKSHITH R NAYAK
CHK 29OCT2016
RAKSHITH R NAYAK
APVD 11DEC2017
PRASHANTH S

PRODUCT SPEC
108-64040-1
APPLICATION SPEC
114-32173
WEIGHT
-

TE Connectivity		NAME	
		AMPMODU 2mm RECEPTACLE, w/B HOUSING, CRIMP, SR, W/ LOCK RAMP	
SIZE	CAGE CODE	DRAWING NO	RESTRICTED TO
A2	00779	C-2316103	-
CUSTOMER DRAWING		SCALE 10:1	SHEET 1 OF 2 REV A

P	LTR	DESCRIPTION	DATE	DWN	APVD
-		SEE SHEET 1	-	-	-

SMART PART NUMBER
2MM -RCD - S__ - BX

PRODUCT SERIES

2MM AMPMODU 2mm SERIES

GENDER / TYPE

RCD RECEPTACLE HOUSING FOR CRIMP WITH DETENT LATCH

NUMBER OF ROWS

S SINGLE ROW

PACKAGING

BX BOX

NUMBER OF PINS PER ROW

XX 07 THROUGH 16
(ENTER TWO DIGITS)

SMART PN EXAMPLES:

- 2MM-RCD-S07-BX:
AMPMODU 2mm, RECEPTACLE HOUSING FOR CRIMP WITH DETENT LATCH, SINGLE ROW, 07 POSITION PER ROW, BOX PACKAGING
- 2MM-RCD-S16-BX:
AMPMODU 2mm, RECEPTACLE HOUSING FOR CRIMP WITH DETENT LATCH, SINGLE ROW, 16 POSITION PER ROW, BOX PACKAGING

THIS DRAWING IS A CONTROLLED DOCUMENT.		DWN 29OCT2016 RAKSHITH R NAYAK	 TE Connectivity	
DIMENSIONS: mm		CHK 29OCT2016 RAKSHITH R NAYAK		
TOLERANCES UNLESS OTHERWISE SPECIFIED:		APVD 11DEC2017 PRASHANTH S	NAME AMPMODU 2mm RECEPTACLE, w/B HOUSING, CRIMP, SR, W/ LOCK RAMP	
0 PLC ±		PRODUCT SPEC	-	
1 PLC ±0.15		APPLICATION SPEC	108-64040-1	
2 PLC ±0.10		WEIGHT	-	
3 PLC ±		CUSTOMER DRAWING	-	
4 PLC ±		SCALE	1:1	
ANGLES ±2°		SHEET	2 OF 2	
FINISH		RESTRICTED TO	-	
MATERIAL SEE NOTE 1		SIZE	A2	
-		CAGE CODE	100779	
-		DRAWING NO	C-2316103	
-		REV	A	