

P	LTR	DESCRIPTION	DATE	DWN	APVD
A		Création - diffusion 331623	01MAR2016	MB	MV
B		Change dimension and tolerances Diffusion N°331764	01JUN2016	MB	MV
C		Change reference item 1 & 2 + + Add product & application spec + Add item 3 - Diffusion 331914	19SEP2016	EL	MV

1 ( ) : cotes pour information / dimensions for information  
 ( ) : cotes de controle / inspection dimensions

2  Instructions de mise en oeuvre à appliquer par le client  
 Customer instructions to be applied by the customer

3 Standards :  
 AAR S-512, APTA RP-E-019-99

4 Catalog number : 27P-KITCON-24S12-3S10

5 Crimping tools :  
 DANIELS CRIMPING HAND CRIMPER HX4 WITH Y543 DIES  
 or  
 DANIELS PNEUMATIC CRIMPER HX23 WITH Y543 DIES

6 Cable sheath stripping lenght = ,54

7 Contacts packed in a labeled bag :  
 27P-KITCON-24S12-3S10





 Groove on contact AWG10 only

 Ref. YS-UC-212601A-AA1A (item2) is a KIT with 3 contacts

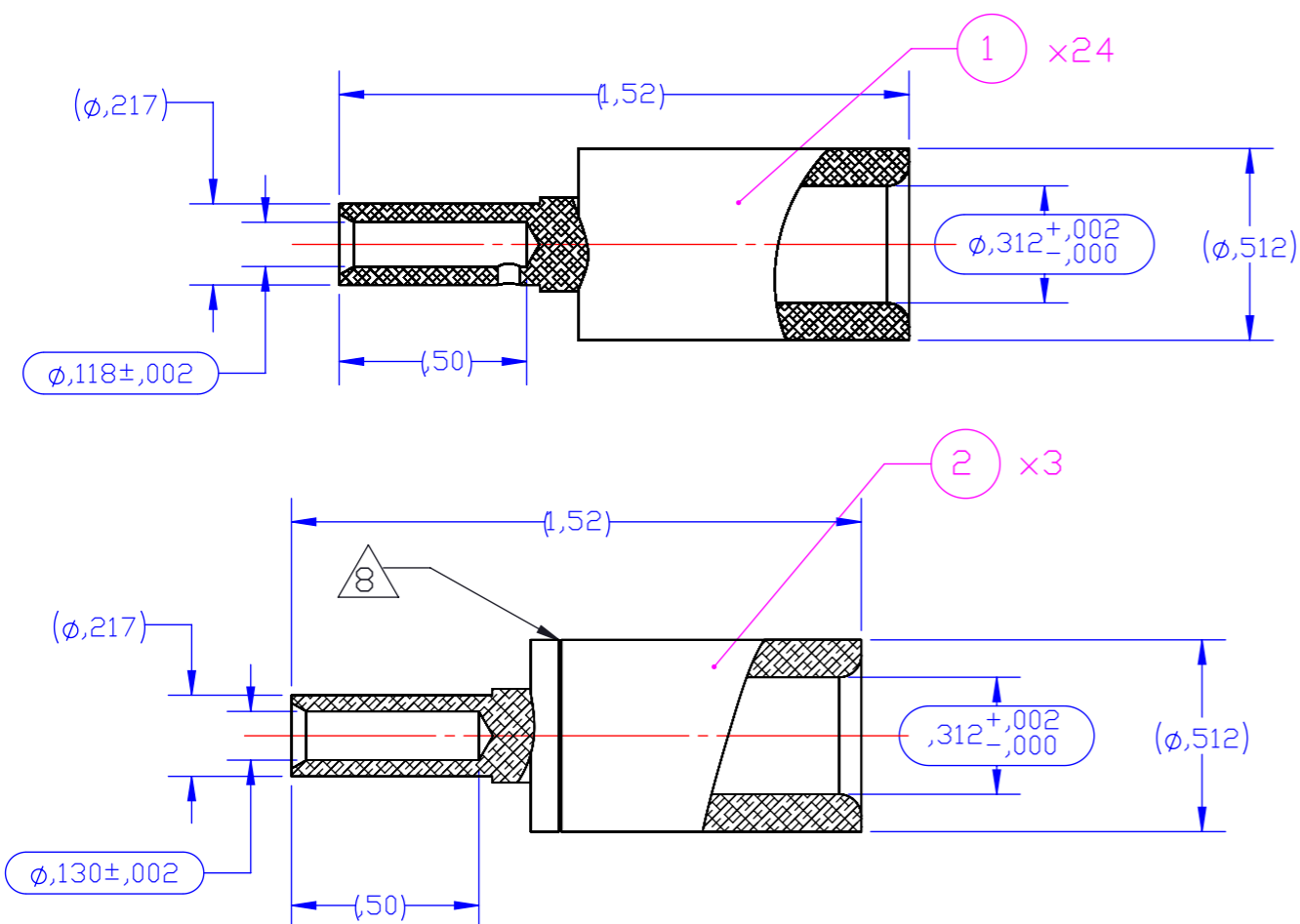
 Ref. YS-UC-212602A-AA1A (item1) is a KIT with 24 contacts

11 Packaging Specification 107-157003







-	-	-	Plastique Plastic	0,2	1	Y0000000000-EMB031	Sachet plastique Plastic bag	3	
	Argenture Silver plating	FMME 1001	Laiton Brass	58.74	1	YS-UC-212601A-AA1A	KIT de 3 contacts femelle AWG 10 KIT with 3 female contacts 10 AWG	2	
	Argenture Silver plating	FMME 1001	Laiton Brass	473.57	1	YS-UC-212602A-AA1A	KIT de 24 contacts femelle AWG 12 et 14 KIT with 24 female contacts 12 and 14 AWG	1	
Observations Remarks	Protection Plating	Fiche matière Data sheet	Matière Material	Masse (g) Weight (g)	Nbr Qty	Codification Part number	Désignation Designation	REP Item	

Référence commerciale / commerciale reference : 27P-KITCON-24S12-3S10

YS-UC-212398A-0000

PART NO

THIS DRAWING IS A CONTROLLED DOCUMENT.		DWN M.BONNIN	01MAR2016	 TE Connectivity	
DIMENSIONS: inch		CHK JF.GALIPAUD	01MAR2016		
TOLERANCES UNLESS OTHERWISE SPECIFIED:		APVD M.VIMARD	01MAR2016		
 0 PLC ± 1 PLC ± 2 PLC ± 3 PLC ± 4 PLC ± ANGLES ±		PRODUCT SPEC 108-157001 	NAME S/A female contacts kit for plug	RESTRICTED TO	
MATERIAL BRASS		FINISH SILVER PLATING	APPLICATION SPEC 408-157000-2 	SIZE A3	CAGE CODE S1894-212398
		WEIGHT 1.049 pound	CUSTOMER DRAWING	SCALE 2:1	SHEET 1 OF 1
				REV C	