

SAFETY ORGANIZATIONS

THIS FILTER HAS BEEN FORMALLY RECOGNIZED, CERTIFIED OR APPROVED BY THE LISTED AGENCY. THEREFORE, ALL TEST/REQUIREMENTS SPECIFIED IN THE LATEST REVISION OF THE FOLLOWING AGENCY STANDARDS HAVE BEEN MET:

UL RECOGNIZED: UL 1283
 CSA CERTIFIED: CSA 22.2, # 0,0.4,8
 VDE APPROVED: EN 60939-2

OPERATING SPECIFICATIONS

LINE CURRENT/VOLTAGE: 20 AMP, 120/250 VAC,
 16 AMP/40°C, 250 VAC

LINE FREQUENCY: 50-60Hz

MAXIMUM LEAKAGE CURRENT,
 EACH LINE TO GROUND: 0.22 mA @120V 60Hz
 0.40 mA @250V 50Hz

OPERATING AMBIENT TEMP. RANGE: -10°C TO +40°C @ RATED CURRENT, I_r .

IN AN AMBIENT, T_0 , HIGHER THAN 40°C, THE MAXIMUM OPERATING CURRENT, I_0 , IS AS FOLLOWS:

$$I_0 = I_r \sqrt{\frac{85 - T_0}{45}}$$

RELIABILITY SPECIFICATIONS:

STORAGE TEMPERATURE: -40°C TO +85°C
 HUMIDITY: 21 DAYS @ 40°C 95% RH.
 CURRENT OVERLOAD TEST: 6 TIMES I_r FOR 8 SECONDS

TEST SPECIFICATIONS:

INDUCTANCE: 0.091 mH NOMINAL
 CAPACITANCE: (MEASURED @ 1KHz, 0.250VAC MAX., 25°C±1°C)
 LINE TO GROUND: 0.0056 μ F ±20%
 LINE TO LINE: 0.0104 μ F ±20%
 DISCHARGE RESISTOR: 1.5M Ω
 L/G AND L/L I.R.
 NO DISCHARGE RESISTOR: 6000M Ω (MIN.) @ 100VDC, 20°C AND 50% RH

RECOMMENDED RECEIVING INSPECTION HIPOT:

LINE TO GROUND: 1500 VAC FOR 1 MINUTE
 LINE TO LINE: 1450 VDC FOR 1 MINUTE

FILTER APPROVAL:

THE BEST WAY TO SELECT AND QUALIFY A FILTER IS FOR YOUR ENGINEERING TO TEST THE UNIT IN YOUR EQUIPMENT.

CATALOG # 20EJT1

ECN #	APPRVD.	DATE
10-010353	PJD	21MAR11

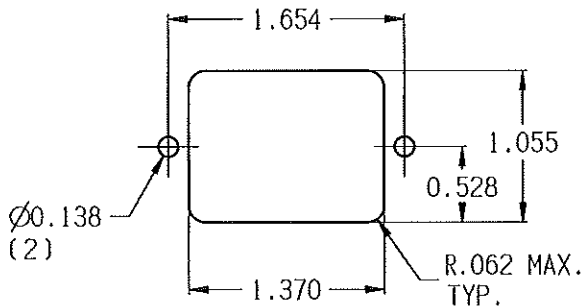
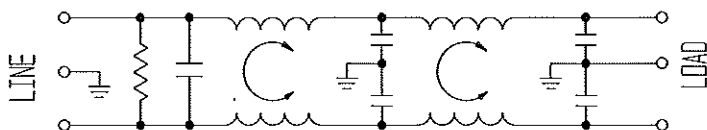
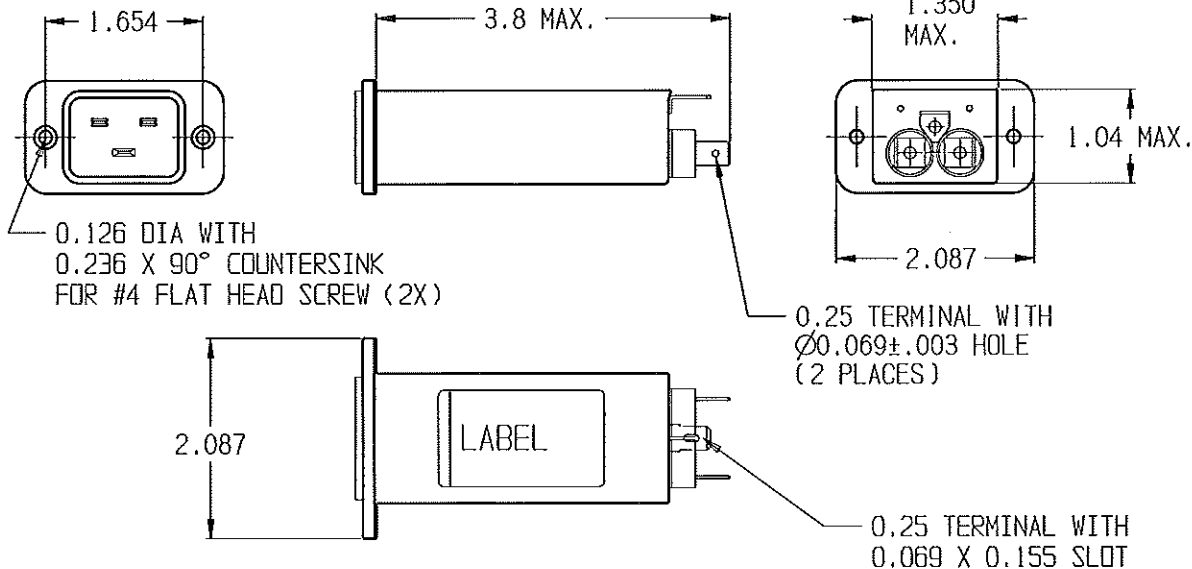

PANEL CUTOUT (FRONT MOUNT)
 TOLERANCE +/- 0.005

50 Ω - 50 Ω (MINIMUM) INSERTION LOSS

FREQUENCY MHz	.1	.15	.5	1.0	5.0	10	30	100	300	1000
COMMON dB	-	-	8	15	42	50	60	58	40	14
DIFF. dB	6	9	20	26	40	35	48	50	56	10

THIRD ANGLE PROJECTION

UNLESS OTHERWISE SPECIFIED, TOLERANCE TO BE ±.025 MATERIAL & FINISH: AS SUPPLIED

This document is proprietary to CORCOM INC and is not to be reproduced nor used for manufacturing purposes except on CORCOM'S prior written consent.

Tyco Electronics
 CORCOM PRODUCTS, 620 S. BUTTERFIELD RD. HANOLEIN IL 60060

POWER LINE FILTER

CAD FILE: 20EJT1-J.cxd	TE#: 0-6609007-8
SCALE: NTS	DATE: 12 JUN 03
DRW. BY: PJD	ORIG: PJD
CATALOG NO. 20EJT1	REV. J