

REVISIONS				
P	LTN	DESCRIPTION	DATE	APVD
F		REVISED PER ECR-20-100915	28APR2021	JP VS
G		REVISED PER ECR-22-130081	12OCT2022	SKR DS
H		REVISED PER ECR-22-146226	09NOV2022	RS DS
H1		REVISED PER ECR-22-158310	15NOV2022	RS DS

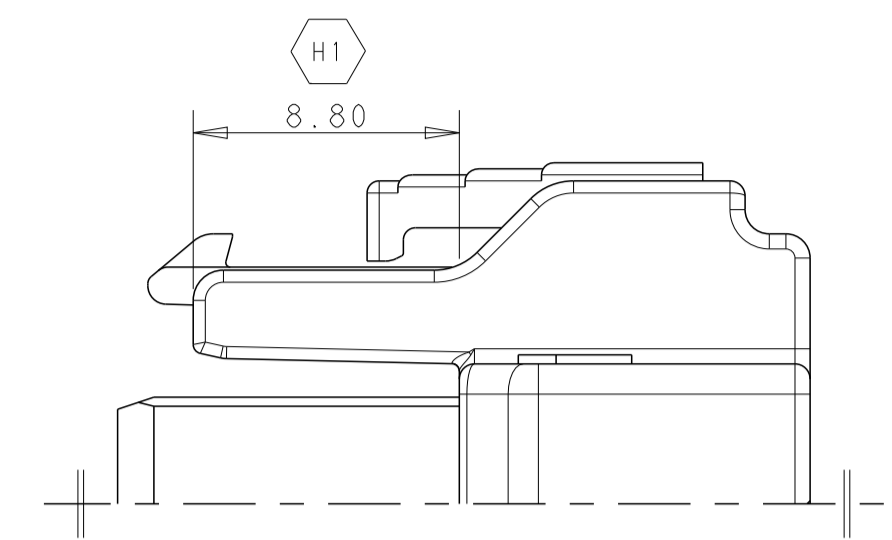

POS.	DIM. A
3*5	33.70
3*4	27.70
3*3	21.70

SIDE RAIL DESIGN FOR LEVEL 1 RESIN

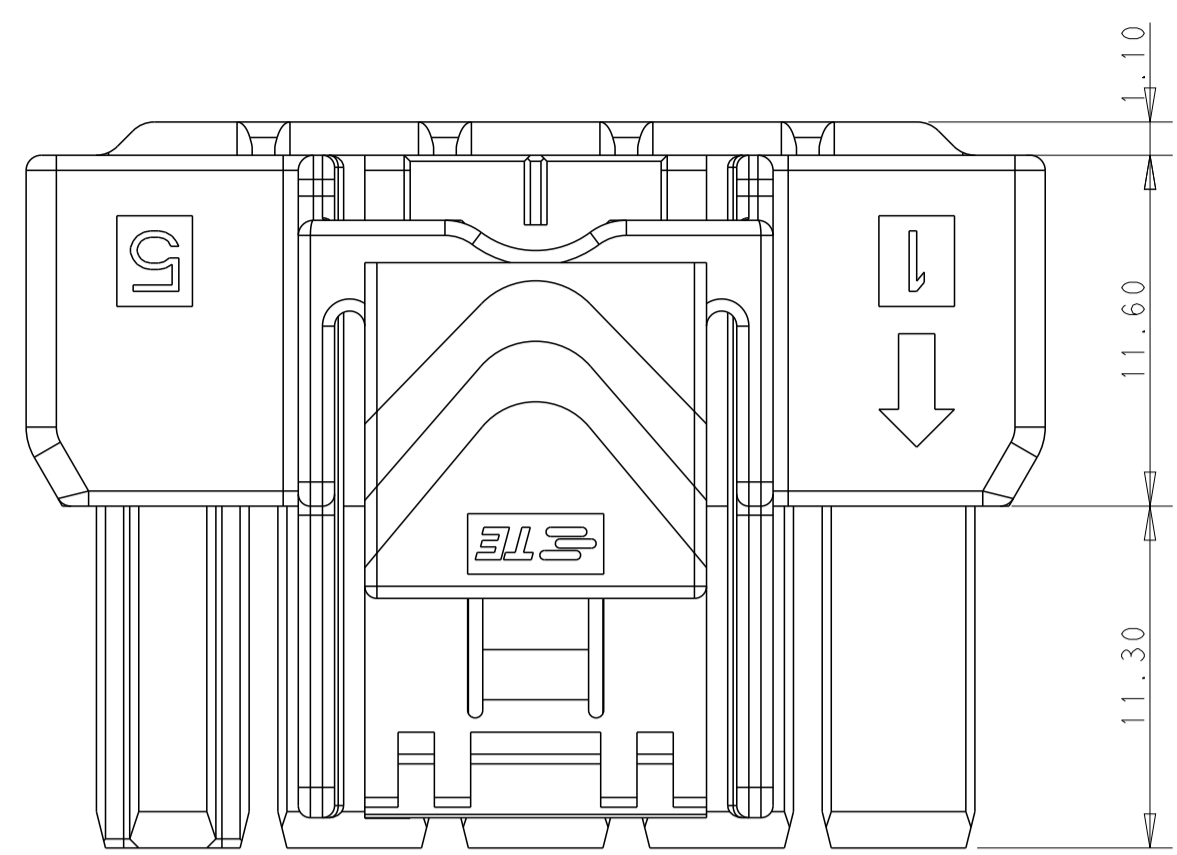
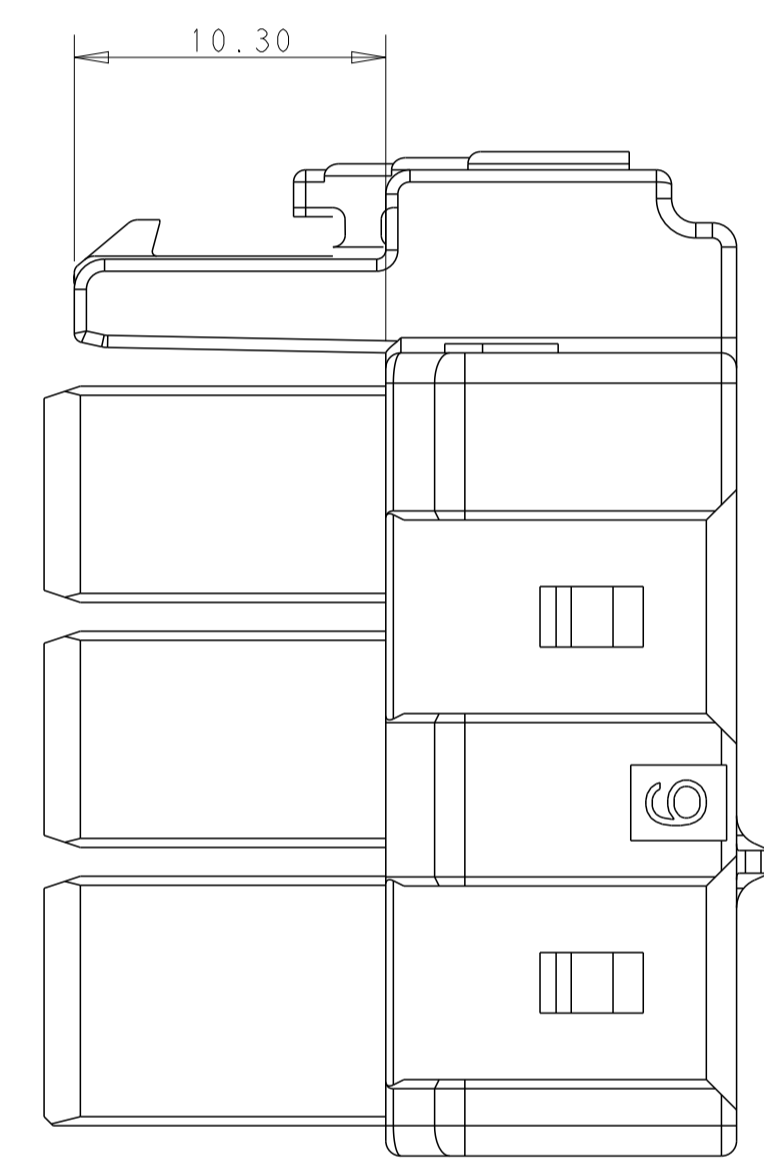
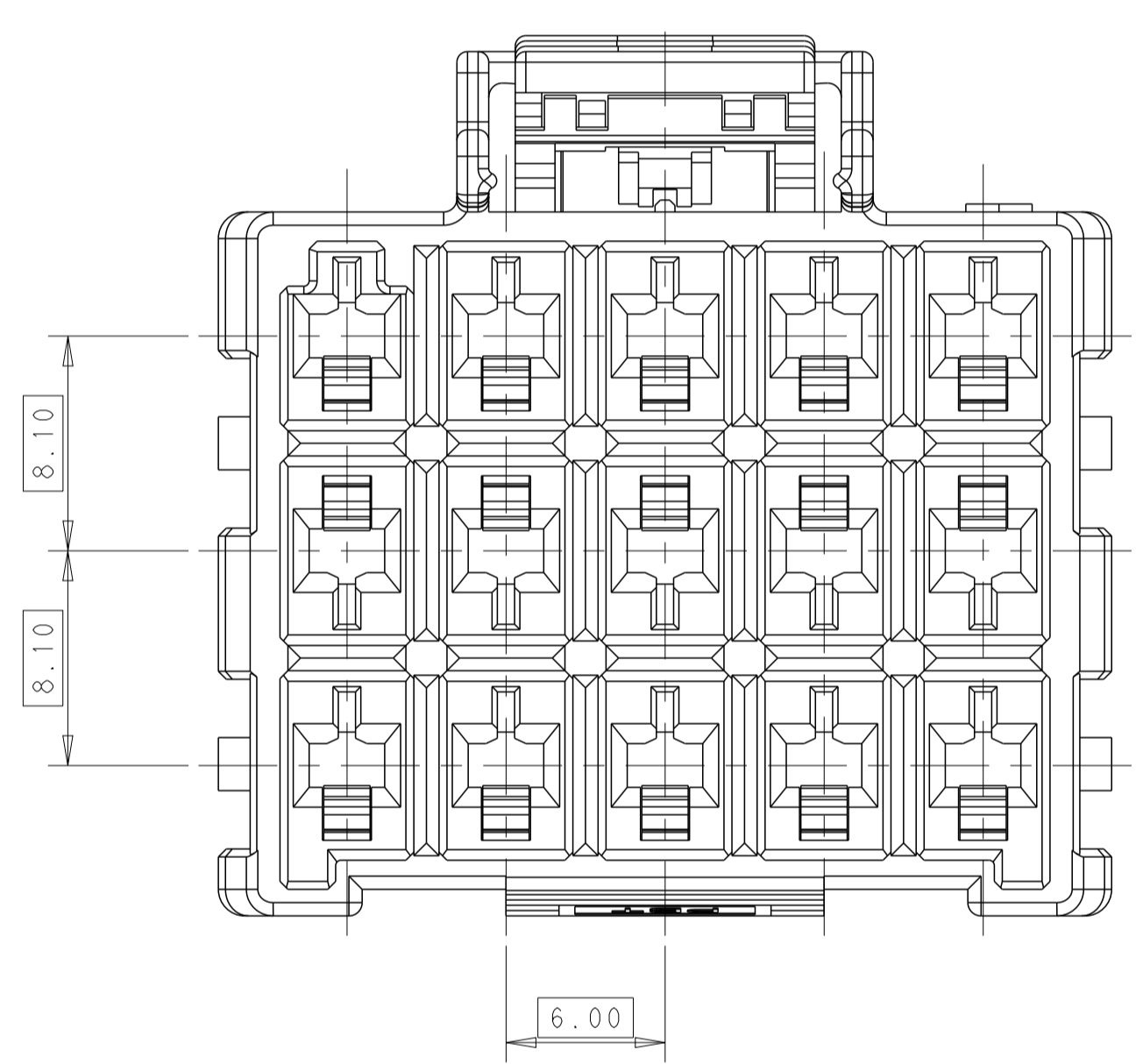

SIDE RAIL DESIGN FOR LEVEL 2 RESIN

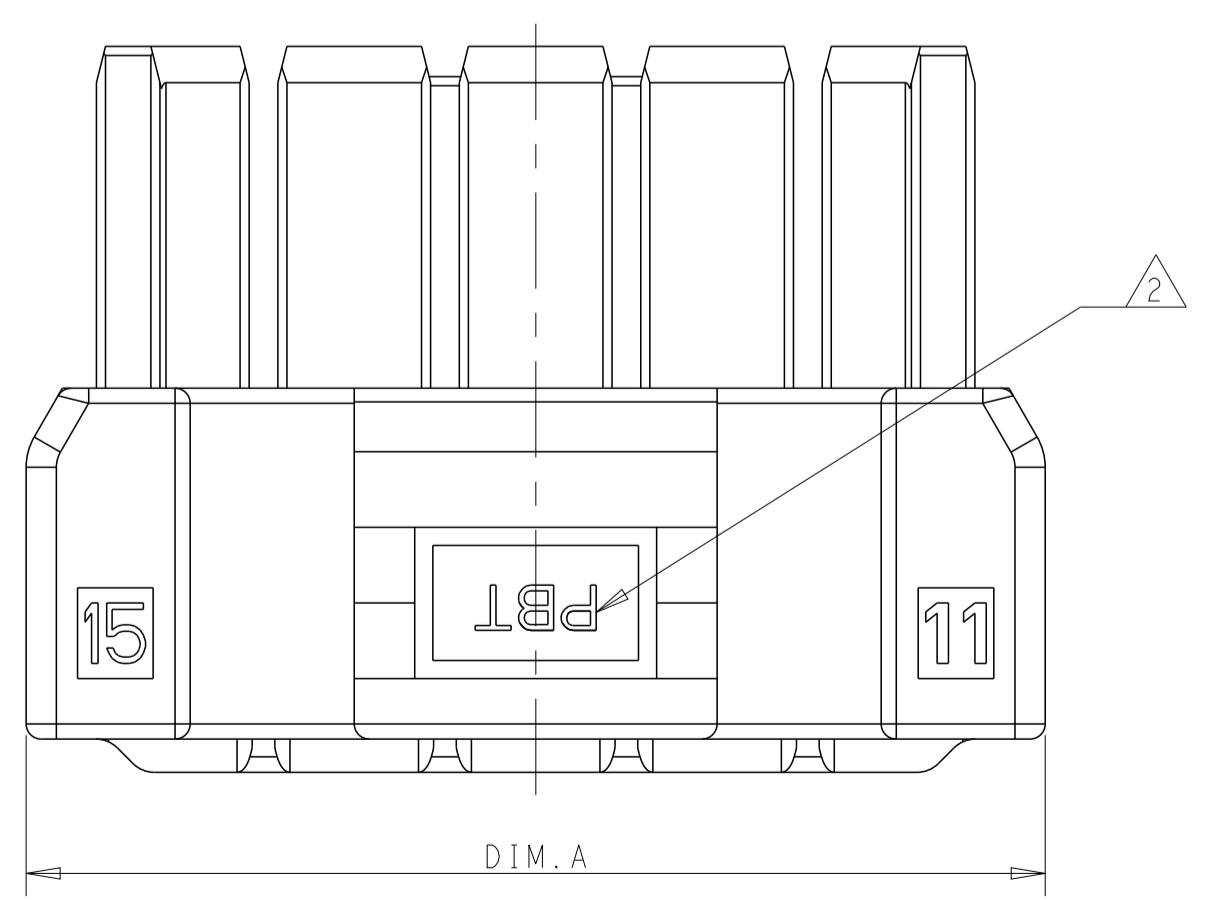
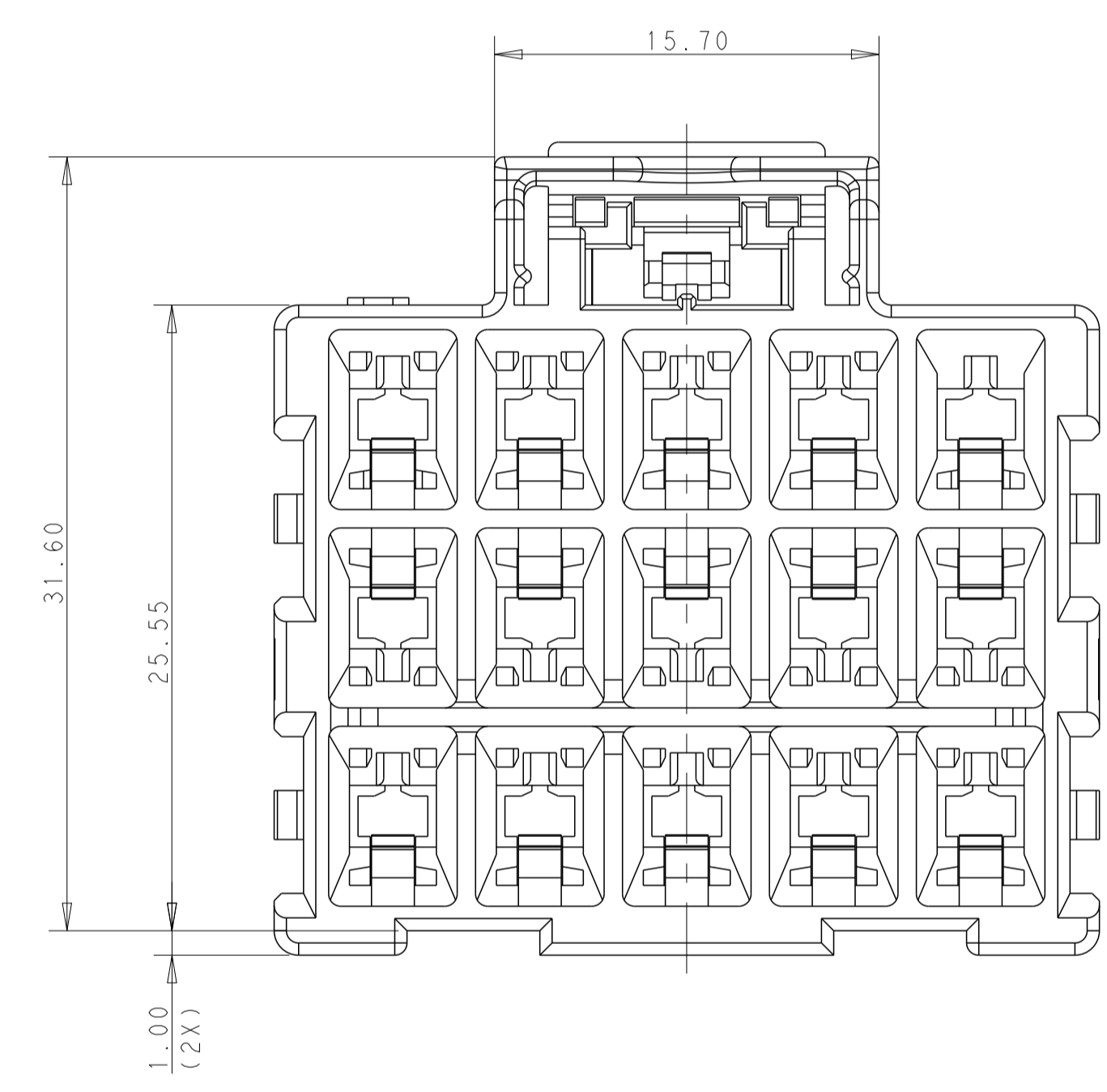

- △ MATERIAL:
 LEVEL 1: PBT, STANDARD TEMPERATURE 105°C
 KEY A: NATURAL; KEY B: PURPLE; KEY C: BLUE; KEY D: YELLOW
 LEVEL 2: PA66, HIGH TEMPERATURE 150°C
 KEY A: LIGHT GREY; KEY B: RED; KEY C: BLACK; KEY D: NATURAL
- △ MATERIAL MARK:
 LEVEL 1: PBT, LEVEL 2: HDT
- 3. APPLICABLE CONTACT P/N
 RECEPTACLE CONTACT: 1971237/1971779/81/83/85/87-*, 2238066-*
- 4. MATING CONN. P/N
 CAP HSG: *-1971874/5-*,
 DOUBLE ROW LOCK PLATE: *-1971778-*, SINGLE ROW LOCK PLATE: *-1971777-*
- △ GLOW WIRE COMPLIANT IN ACCORDANCE WITH IEC 60335-1. THIS IS BASED ON THE PRODUCT MEETING A GWEPT 850°C TEST AND RESIN GWIT GREATER THAN OR EQUAL TO 775°C.

THIS DRAWING IS A CONTROLLED DOCUMENT.		OWN TOMMY WU 09JUL2012	TE Connectivity
DIMENSIONS: mm		CHK HAPYE WU 09JUL2012	
TOLERANCES UNLESS OTHERWISE SPECIFIED:		APVD YUHONG MAO 09JUL2012	NAME PLUG HOUSING, TRIPLE ROW POWER TRIPLE LOCK
0 PLC ±0.35	1 PLC ±0.25	PRODUCT SPEC	SIZE CAGE CODE DRAWING NO
2 PLC ±0.25	3 PLC ±0.25	APPLICATION SPEC	RESTRICTED TO
4 PLC ±0.25	ANGLES ±0.5	114-106118	A100779C=1971876
MATERIAL	FINISH	WEIGHT	SCALE 4:1 SHEET 1 OF 2 REV H1
Customer Drawing			

REVISIONS				
P.	LTN.	DESCRIPTION	DATE	APVD.
-	-	SEE SHEET 1	-	-

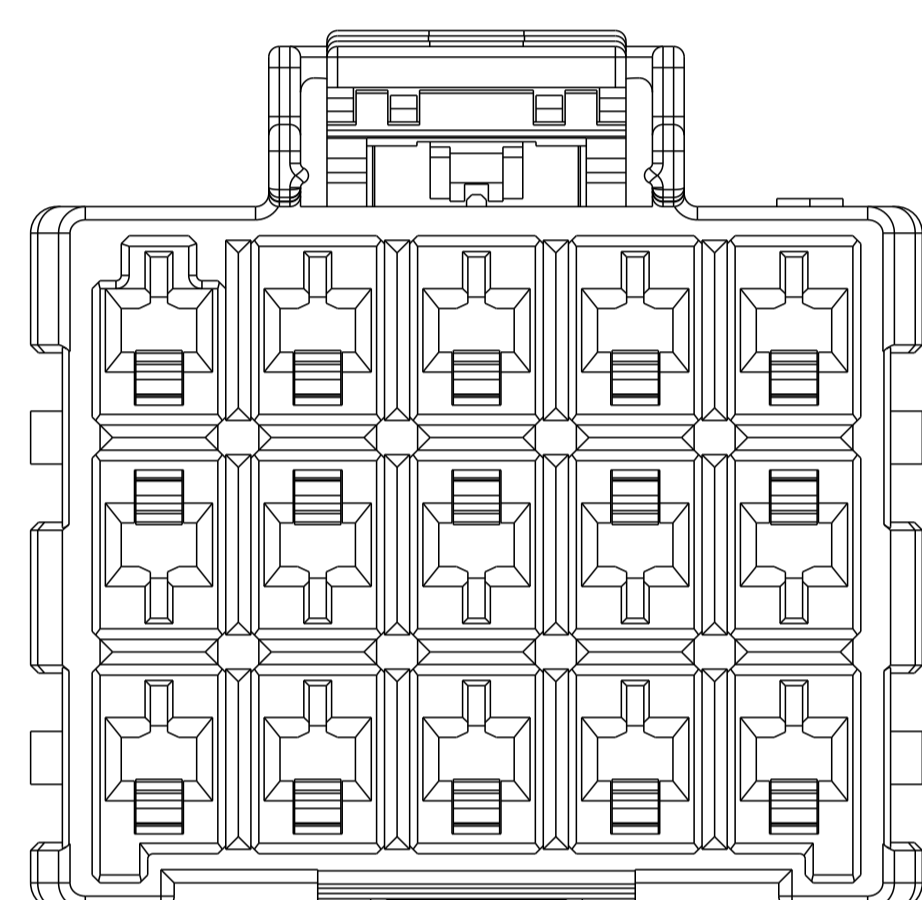
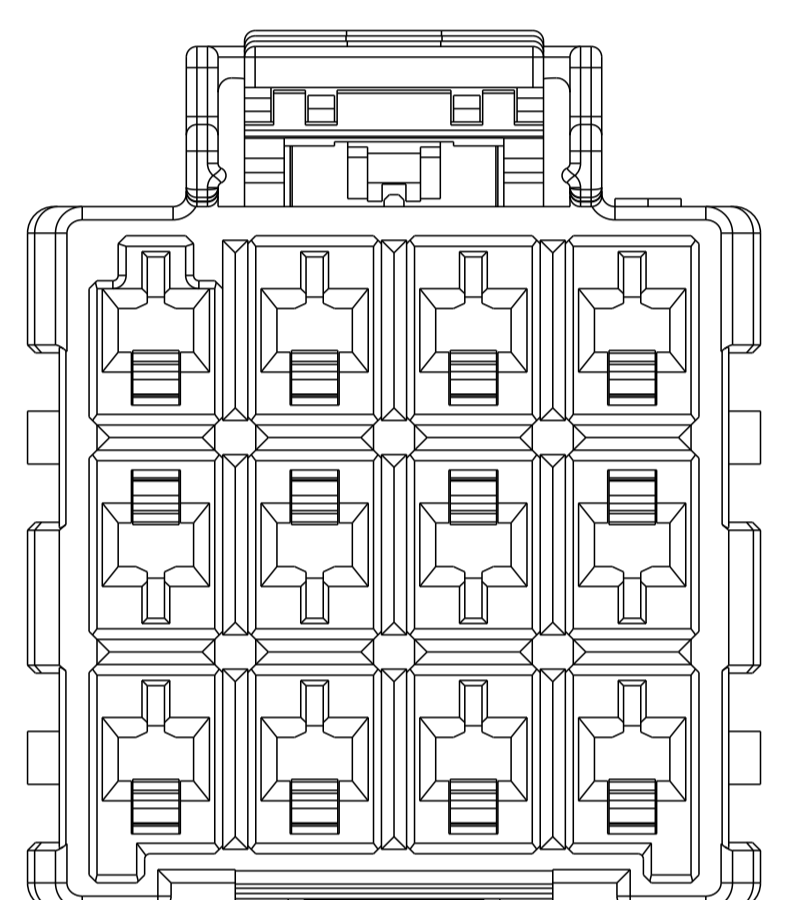
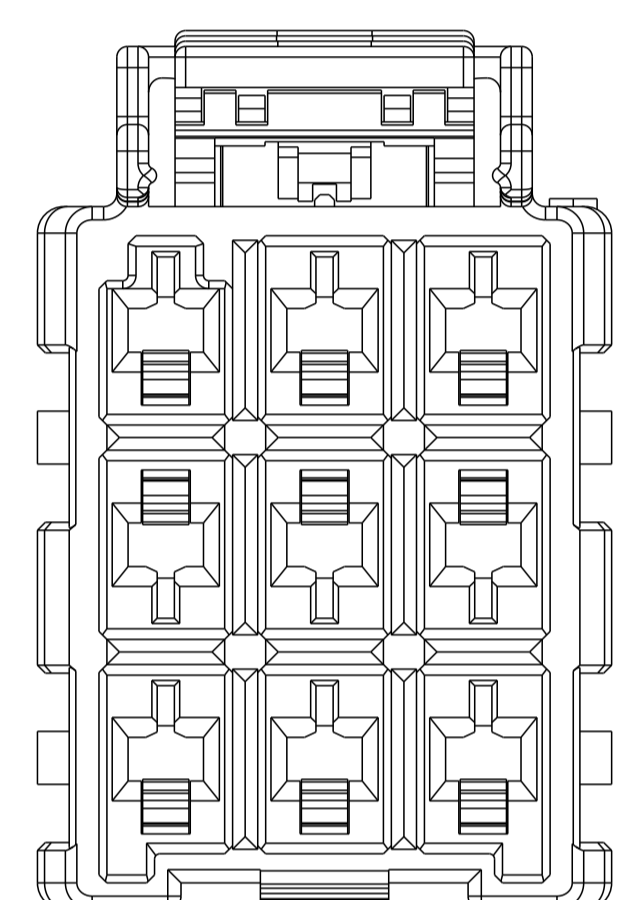
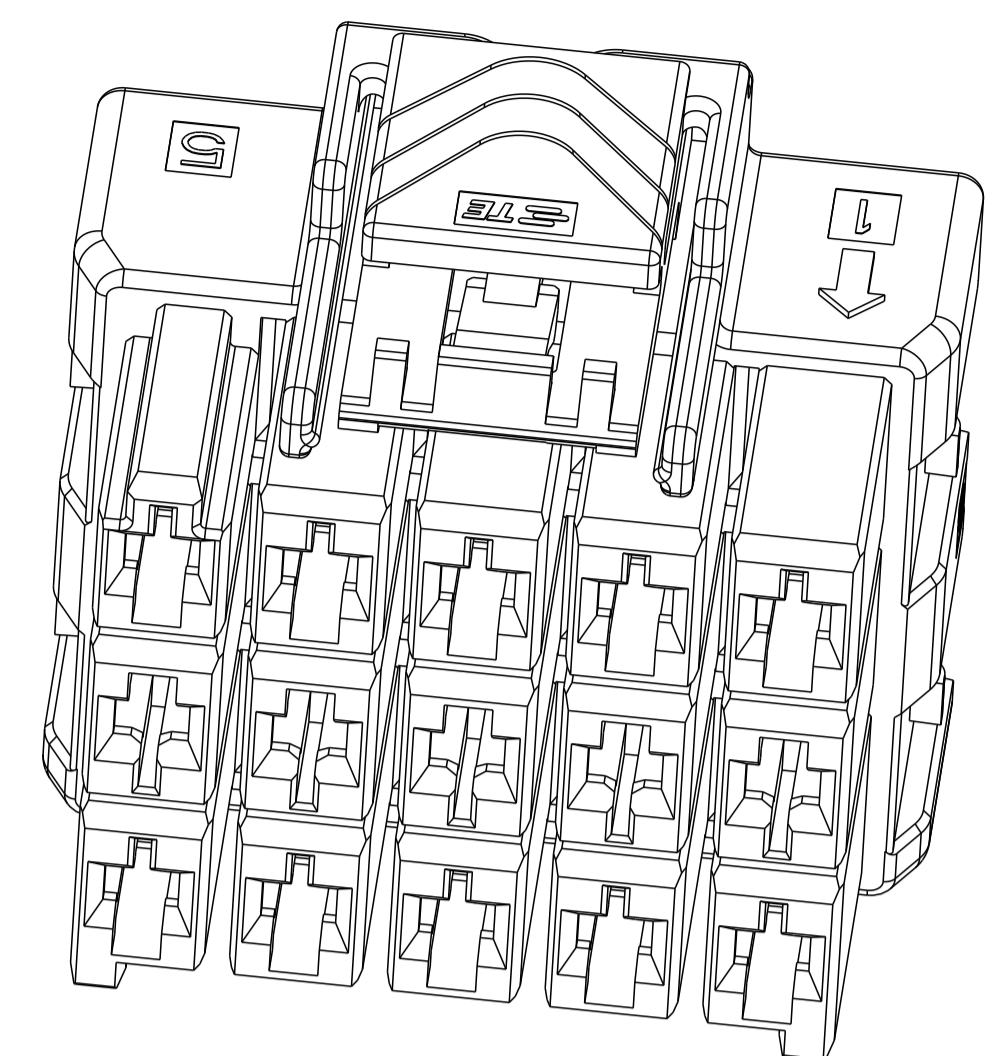
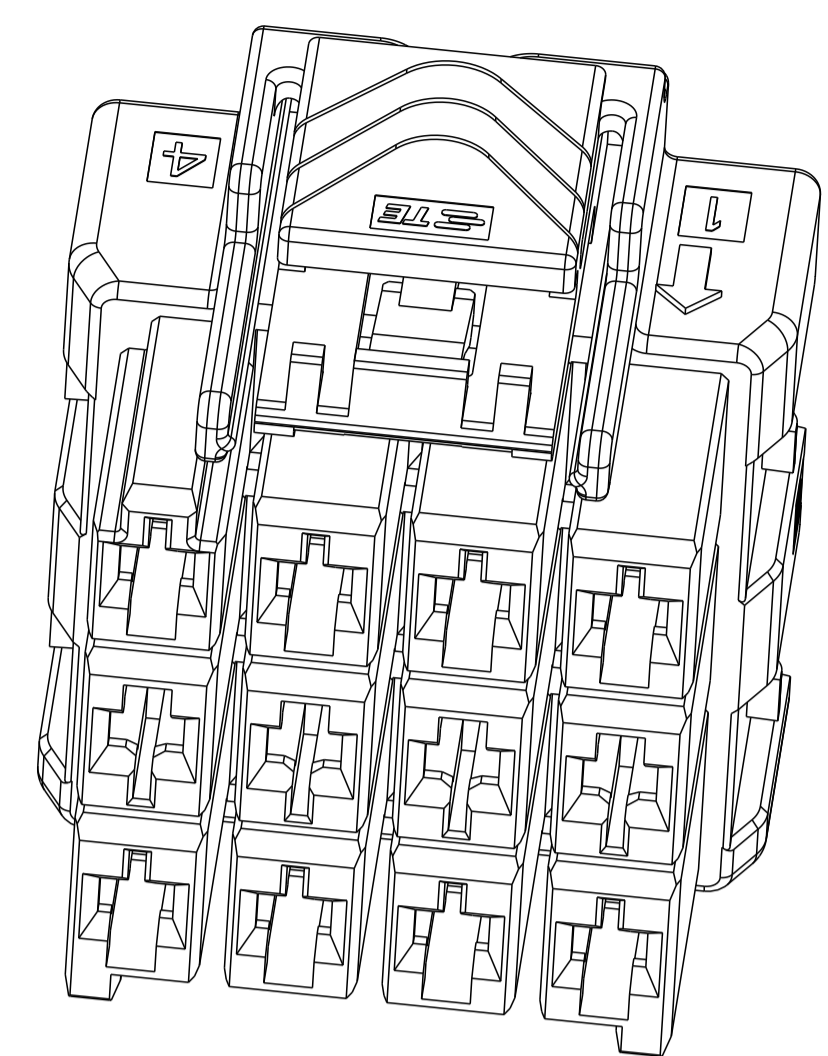
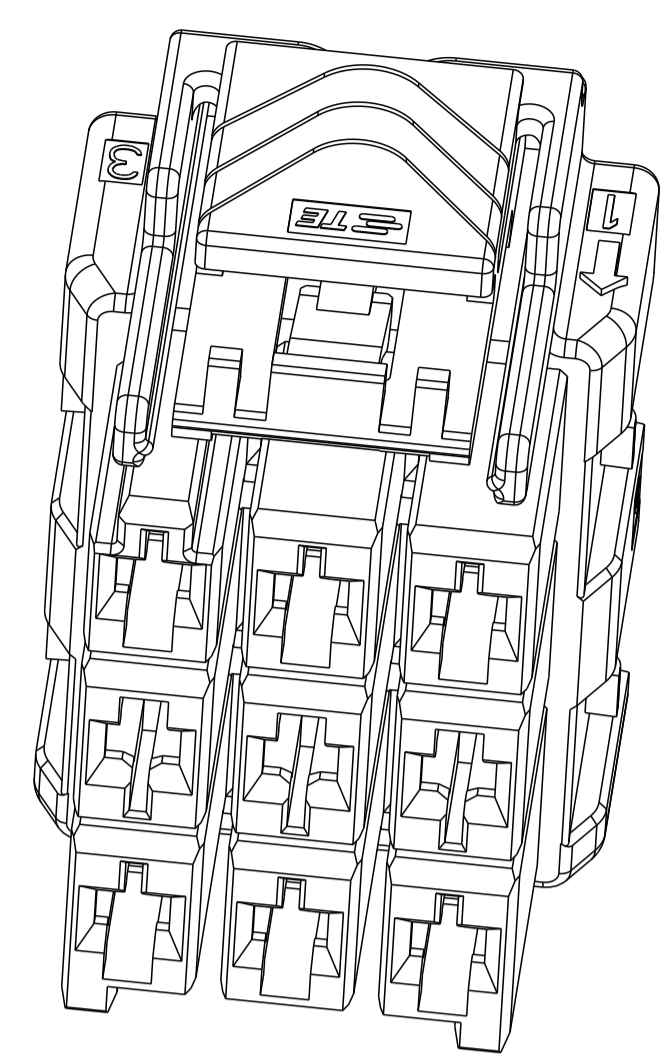

3*3 POSITIONS

3*4 POSITIONS

3*5 POSITIONS

3*5	LEVEL 1	KEY A	1-1971876-7
		KEY B	2-1971876-7
		KEY C	3-1971876-7
		KEY D	4-1971876-7
3*4	LEVEL 2	KEY A	5-1971876-7
		KEY B	6-1971876-7
		KEY C	7-1971876-7
		KEY D	8-1971876-7
3*4	LEVEL 1	KEY A	1-1971876-4
		KEY B	2-1971876-4
		KEY C	3-1971876-4
		KEY D	4-1971876-4
3*3	LEVEL 2	KEY A	5-1971876-4
		KEY B	6-1971876-4
		KEY C	7-1971876-4
		KEY D	8-1971876-4
3*3	LEVEL 1	KEY A	1-1971876-3
		KEY B	2-1971876-3
		KEY C	3-1971876-3
		KEY D	4-1971876-3
3*3	LEVEL 2	KEY A	5-1971876-3
		KEY B	6-1971876-3
		KEY C	7-1971876-3
		KEY D	8-1971876-3
POS.	MATERIAL	KEY	P/N

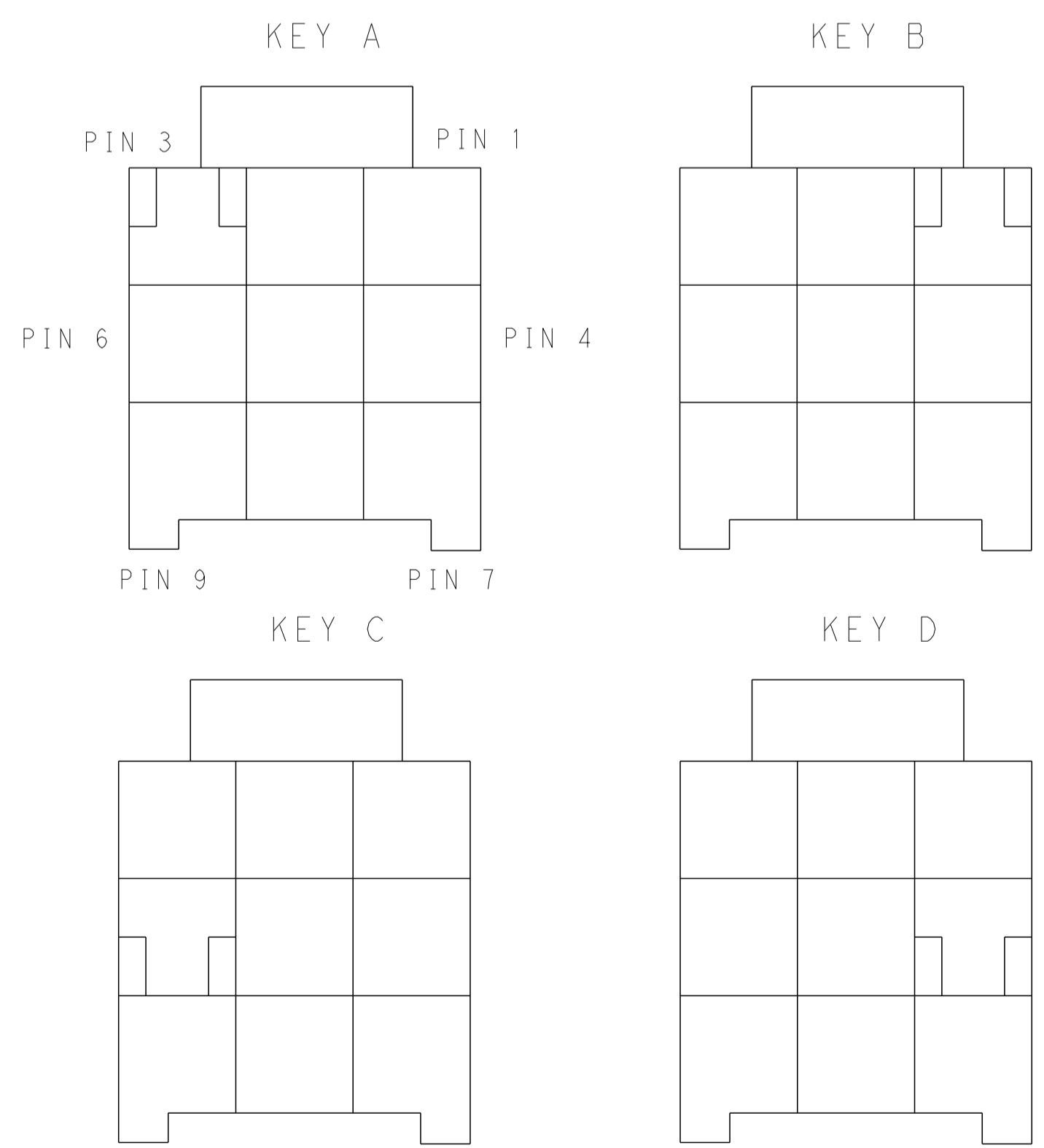

KEYING FOR 3*3 POS.

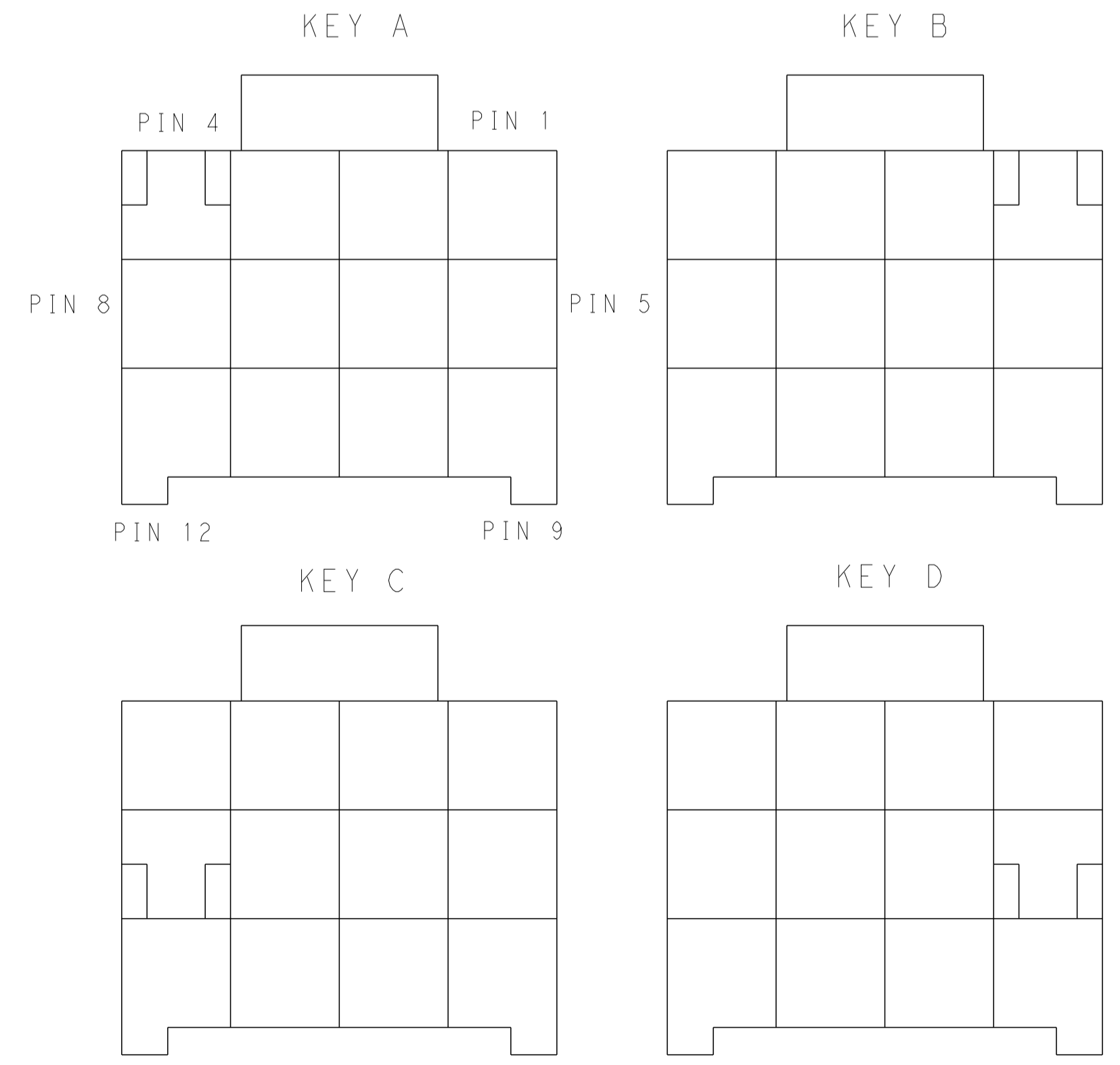

KEYING FOR 3*4 POS.

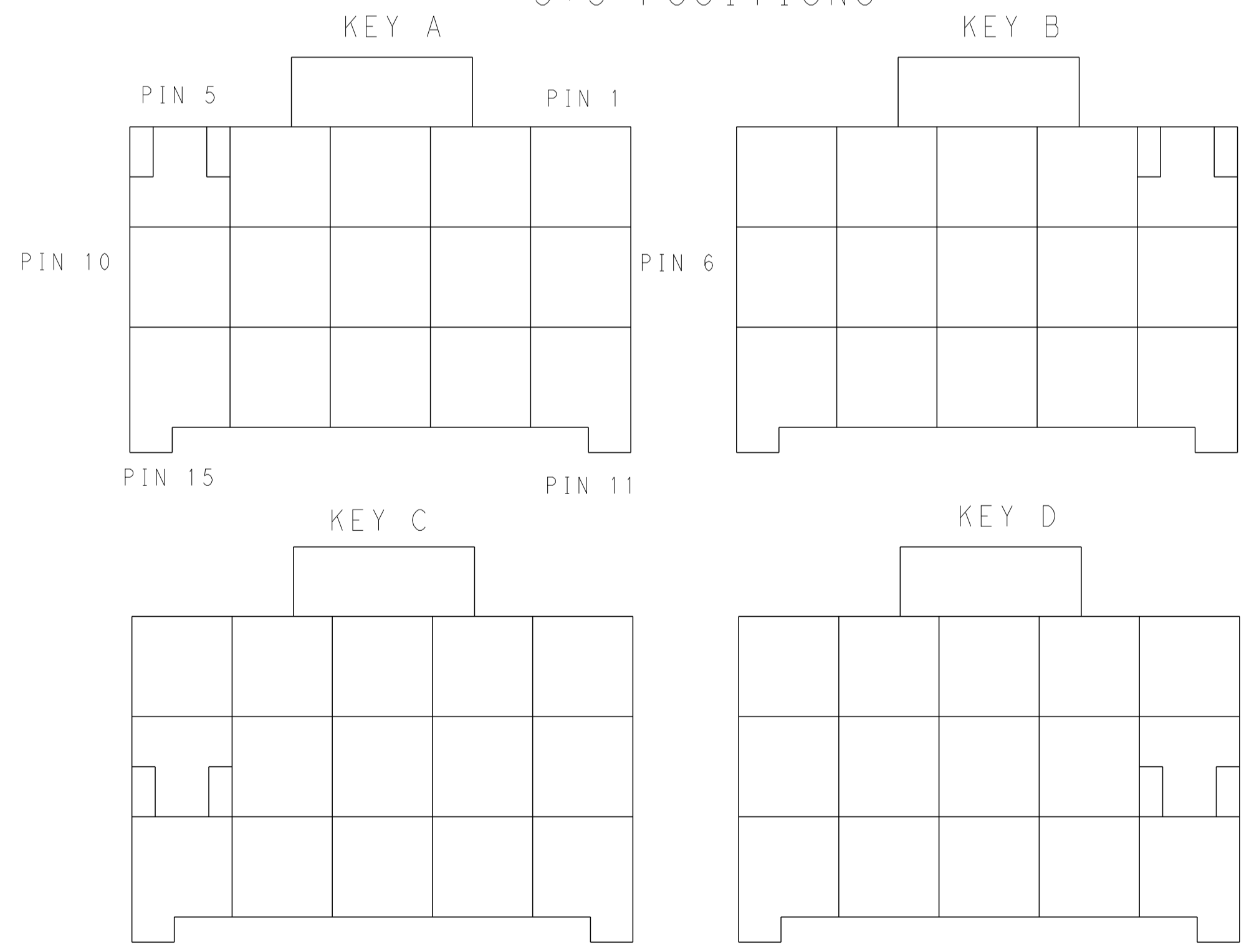

KEYING FOR 3*5 POS.

THIS DRAWING IS A CONTROLLED DOCUMENT.

DIMENSIONS:	TOLERANCES UNLESS OTHERWISE SPECIFIED:	OWN TOMMY WU 09JUL2012	CHK HAPYE WU 09JUL2012	APVD YUHONG MAO 09JUL2012
mm	0 PLC ±0.35 1 PLC ±0.25 2 PLC ±0.25 3 PLC ±0.25 4 PLC ±0.25 ANGLES ±0.1	NAME	PLUG HOUSING, TRIPLE ROW POWER TRIPLE LOCK	
MATERIAL	FINISH	SIZE	CAGE CODE	DRAWING NO
-	-	A1	108-106118	114-106118
Customer Drawing		WEIGHT	SCALE	SHEET 2 OF 2
				REV H1

TE Connectivity