

THIS INFORMATION IS CONFIDENTIAL AND IS DISCLOSED TO YOU ON CONDITION THAT NO FURTHER DISCLOSURE IS MADE BY YOU TO OTHER THAN AMP PERSONNEL WITHOUT WRITTEN AUTHORIZATION FROM AMP (TAIWAN) LTD. DIMENSIONS IN MILLIMETERS. DO NOT SCALE PRINT.

METRIC

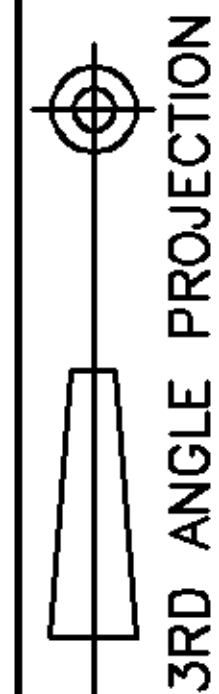

NUMBER
C-1734087

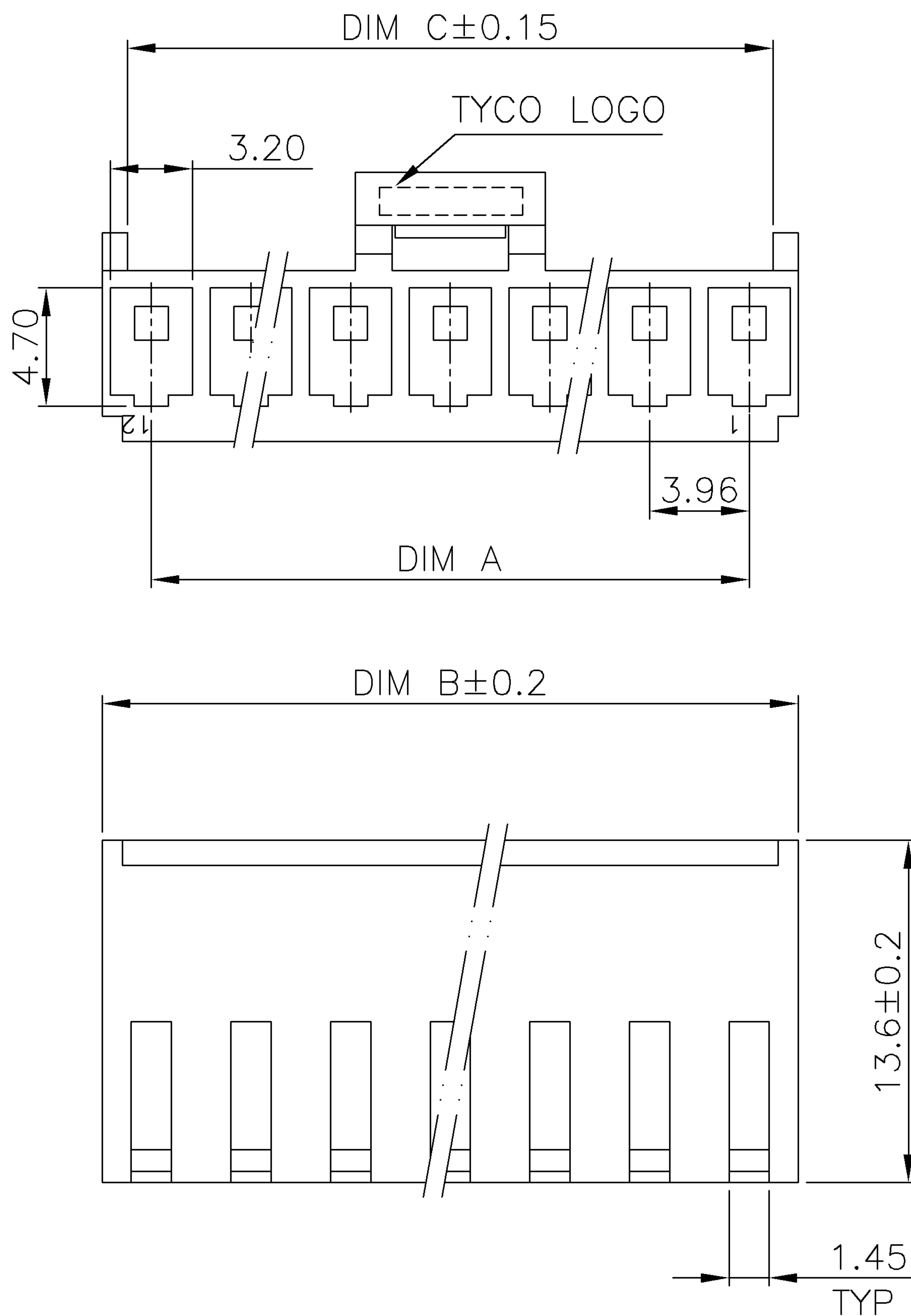

NOTE:

1. MATERIAL :

HOUSING : THERMOPLASTIC UL94V-0,
WHITE COLOR.

2 OBSOLETE PARTS: OBSOLETE CIS STREAMLINING PER
D.RENAUD/D.SINISI

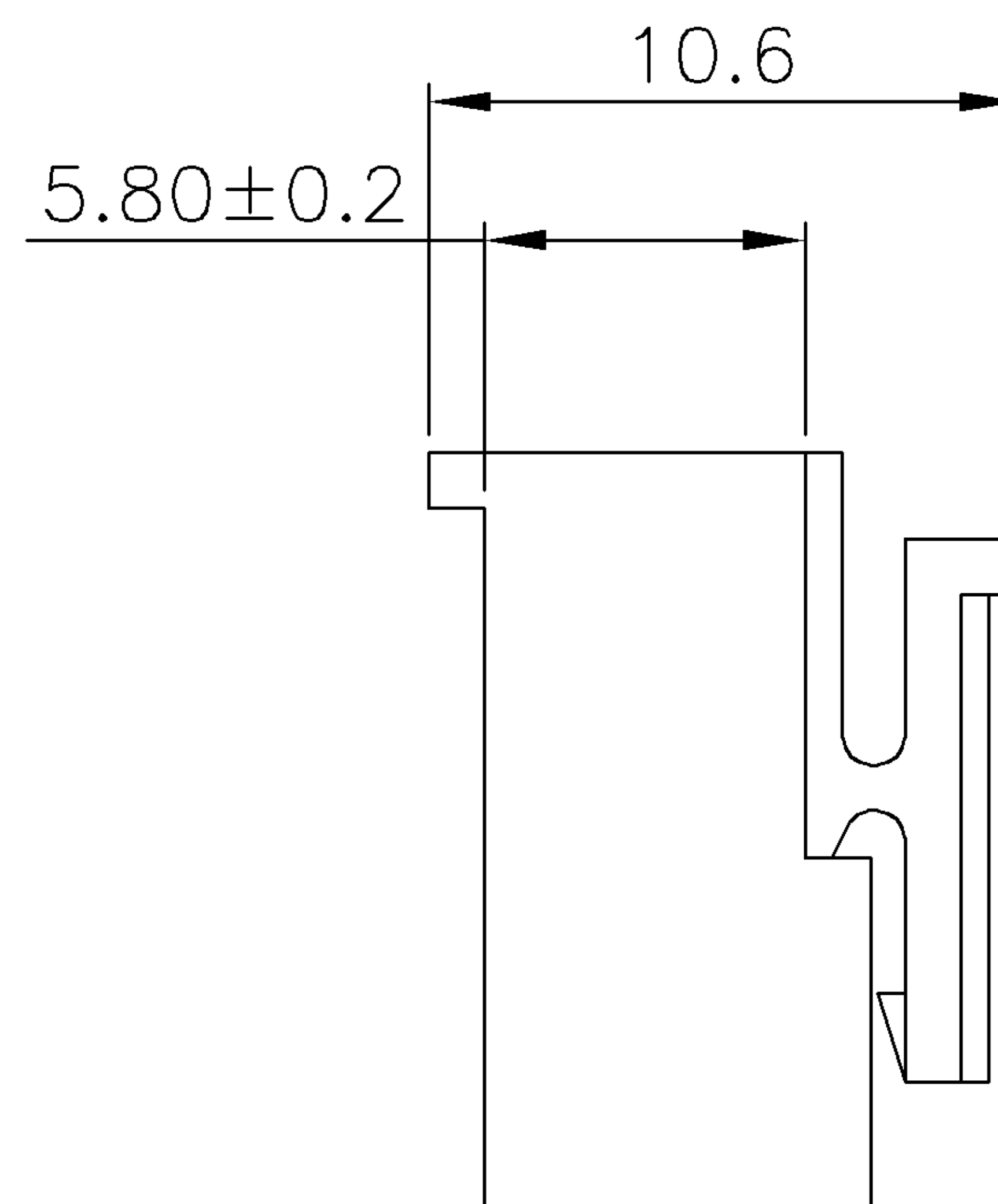

HSG. COLOR	DIM. C	DIM. B	DIM. A	CIRCUITS	PART NUMBER
BLACK	45.52	47.60	43.56±0.20	12	3-1734087-2
	41.56	43.56	39.60±0.20	11	3-1734087-1
	37.60	39.60	35.64±0.20	10	3-1734087-0
	33.56	35.64	31.68±0.15	9	2-1734087-9
	29.60	31.68	27.72±0.15	8	2-1734087-8
	25.64	27.72	23.76±0.15	7	2-1734087-7
	21.68	23.76	19.80±0.15	6	2-1734087-6
	17.72	19.80	15.84±0.08	5	2-1734087-5
	13.76	15.84	11.88±0.08	4	2-1734087-4
	9.80	11.88	7.92±0.08	3	2-1734087-3
	5.84	7.92	3.96±0.08	2	2-1734087-2
	NATURAL	45.52	47.60	43.56±0.20	12
41.56		43.56	39.60±0.20	11	1-1734087-1
37.60		39.60	35.64±0.20	10	1-1734087-0
33.56		35.64	31.68±0.15	9	1734087-9
29.60		31.68	27.72±0.15	8	1734087-8
25.64		27.72	23.76±0.15	7	1734087-7
21.68		23.76	19.80±0.15	6	1734087-6
17.72		19.80	15.84±0.08	5	1734087-5
13.76		15.84	11.88±0.08	4	1734087-4
9.80		11.88	7.92±0.08	3	1734087-3
5.84		7.92	3.96±0.08	2	1734087-2

TOLERANCES UNLESS OTHERWISE SPECIFIED: 0 PLC ± 1 PLC ±0.25 2 PLC ±0.15 3 PLC ±0.05 ANGLES ±	DWN O. HU 13-APR-2004	 TYCO HOLDINGS (BERMUDA) VII LTD. TAIWAN BRANCH
	CHK S. HOU 13-APR-2004	
MATERIAL SEE NOTE	APVD T. KE 13-APR-2004	NAME HPI 3.96 MM PITCH, SHROUDED, HOUSING
FINISH SEE NOTE	PRODUCT SPEC 108-57468	
	QUALIFICATION TEST REPORT 501-57538	LOC DW A ₃
	WEIGHT	DRAWING NO C-1734087
		REV O1
		SCALE --
		SHEET 1 OF 2

O1	REVISED	ECO-09-026495	KK AEG	28NOV 09
O	FIRST RELEASED	FZ00-0057-04	OH SH	16APR 2004
LTR	REVISION RECORD	ECN	DWN CHK	DATE

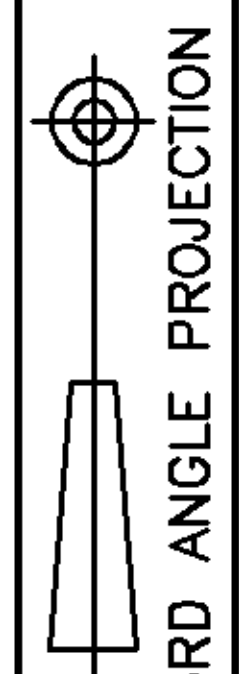

THIS INFORMATION IS CONFIDENTIAL AND IS DISCLOSED TO YOU ON CONDITION THAT NO FURTHER DISCLOSURE IS MADE BY YOU TO OTHER THAN AMP PERSONNEL WITHOUT WRITTEN AUTHORIZATION FROM AMP (TAIWAN) LTD. DIMENSIONS IN MILLIMETERS. DO NOT SCALE PRINT.

NUMBER C-1734087
 METRIC

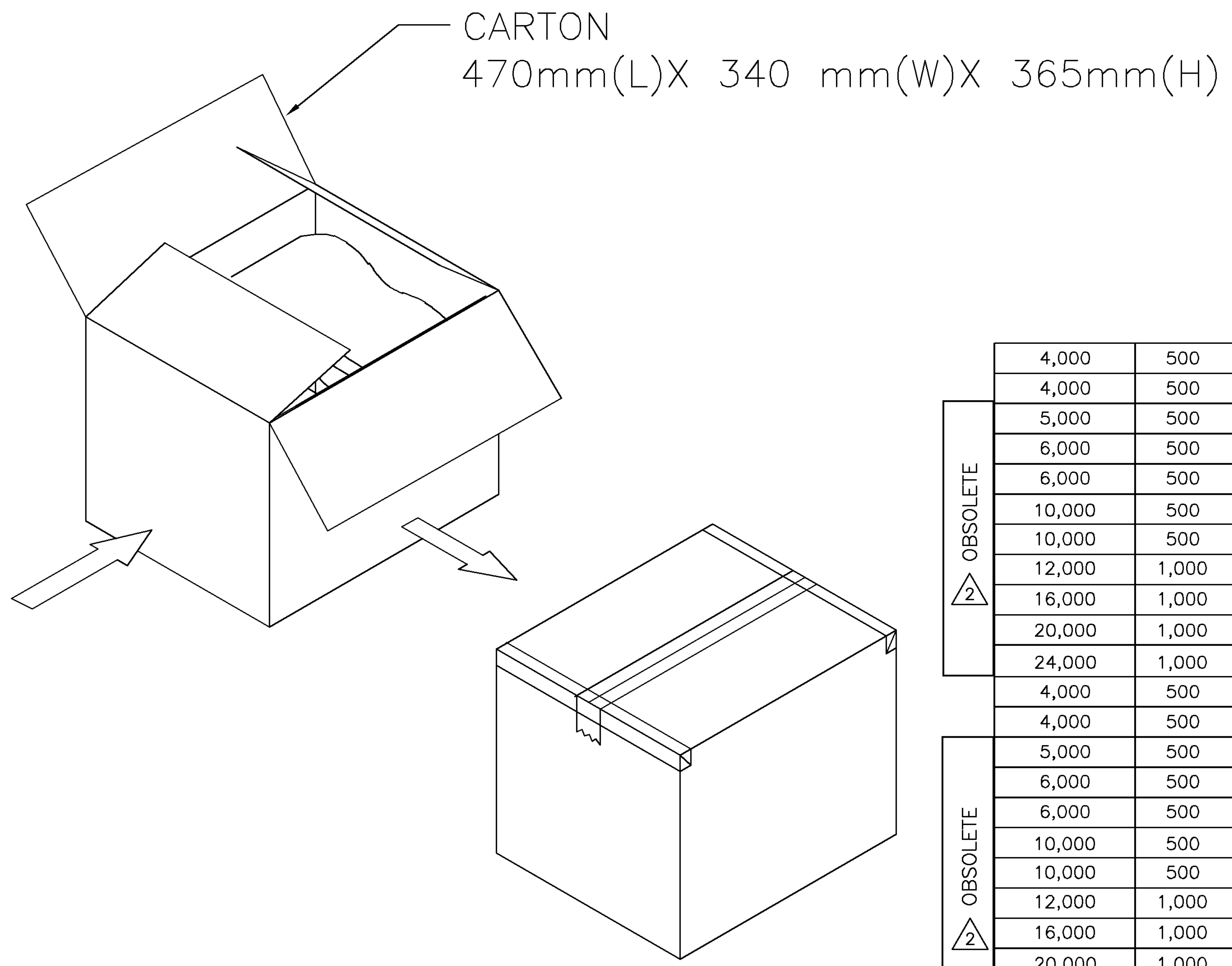
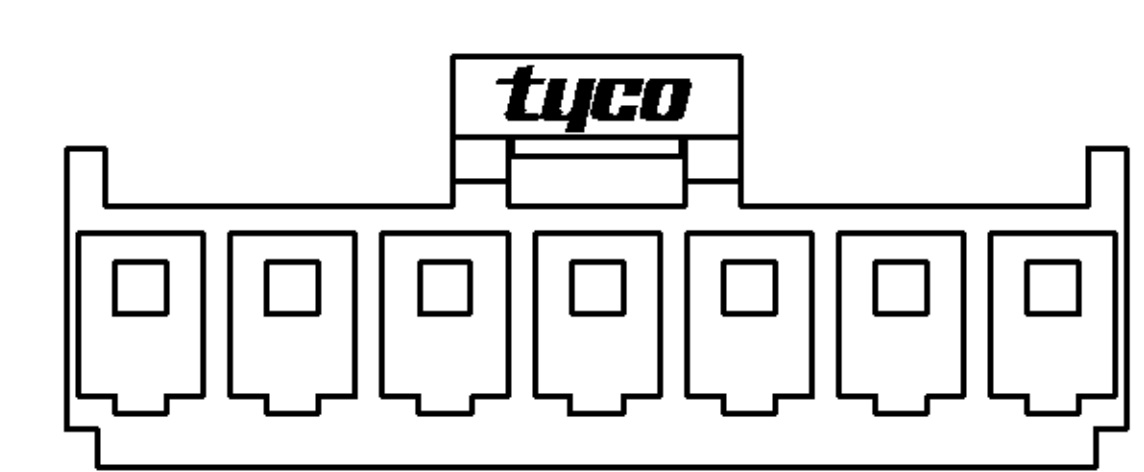
POLY BAG



OBSOLETE 2	4,000	500	3-1734087-2
	4,000	500	3-1734087-1
	5,000	500	3-1734087-0
	6,000	500	2-1734087-9
	6,000	500	2-1734087-8
	10,000	500	2-1734087-7
	10,000	500	2-1734087-6
	12,000	1,000	2-1734087-5
	16,000	1,000	2-1734087-4
	20,000	1,000	2-1734087-3
24,000	1,000	2-1734087-2	
OBSOLETE 2	4,000	500	1-1734087-2
	4,000	500	1-1734087-1
	5,000	500	1-1734087-0
	6,000	500	1734087-9
	6,000	500	1734087-8
	10,000	500	1734087-7
	10,000	500	1734087-6
	12,000	1,000	1734087-5
	16,000	1,000	1734087-4
	20,000	1,000	1734087-3
24,000	1,000	1734087-2	
APQ (PCS/CARTON)		PPQ (PCS/BAG)	PART NUMBER

TOLERANCES UNLESS OTHERWISE SPECIFIED: 0 PLC ± 1 PLC ± 2 PLC ± 3 PLC ± ANGLES ±	DWN	O. HU	 TYCO HOLDINGS (BERMUDA) VII LTD. TAIWAN BRANCH 			
		13-APR-2004			S. HOU	
MATERIAL SEE NOTE	APVD	T. KE	NAME HPI 3.96 MM PITCH, SHROUDED, HOUSING			
		13-APR-2004				
FINISH SEE NOTE	PRODUCT SPEC		LOC	SIZE	DRAWING NO	REV
	APPLICATION SPEC		DW	A ₃	C-1734087	O1
	WEIGHT		SCALE	--	SHEET	2 OF 2

LTR	SEE SHEET 1.	ECN	DWN	CHK	DATE
	REVISION RECORD				

8 7 6 5 4 3 2 1

CUSTOMER DRAWING