

LOC	DIST	REVISIONS					
E	B	P	LTR	DESCRIPTION	DATE	DWN	APVD
			BA1	AS PER ECR-09-006166	17-MAR-09	SM	JC

FOR FURTHER INFORMATION SEE DATA SHEET FOR
CPF SERIES-THIN FILM PRECISION CHIP RESISTORS

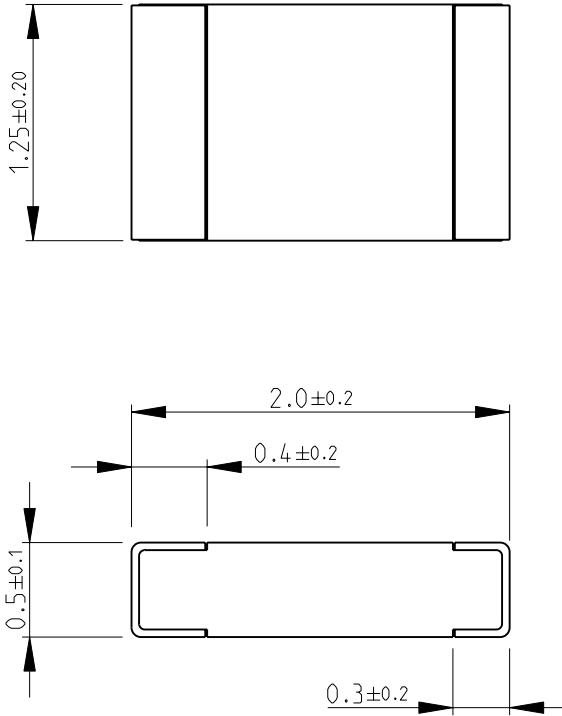

RoHS Compliant

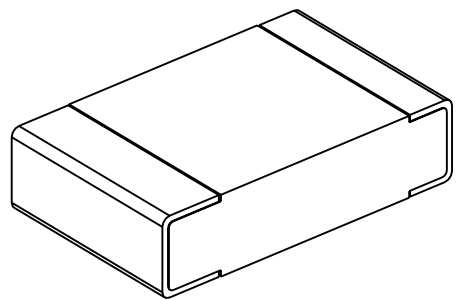

2008

RELEASED FOR PUBLICATION

THIS DRAWING IS UNPUBLISHED.

BY TYCO ELECTRONICS CORPORATION. ALL RIGHTS RESERVED.

DIMENSIONS: mm	DWN	SUBHASH.M	23-Sep-08	MATERIAL	-	FINISH	-
	CHK	PRAKASH.S	23-Sep-08	Tyco Electronics Corporation Dorcan, Swindon, SN3 5HH			
TOLERANCES UNLESS OTHERWISE SPECIFIED:	APVD	STEPHEN.P	23-Sep-08				
	0 PLC	± 0.2	PRODUCT SPEC	-	SIZE	CAGE CODE	DRAWING NO
1 PLC	± 0.1	APPLICATION SPEC	-	A 4	00779	© = 1614890	-
2 PLC	\pm	WEIGHT	-	CUSTOMER DRAWING			
3 PLC	\pm			SCALE	25:1	SHEET	1 OF 1
4 PLC	\pm					REV	BA1
ANGLES	$\pm 5^\circ$						