

LOC	DIST	REVISIONS					
E	B	P	LTR	DESCRIPTION	DATE	DWN	APVD
			BA	NEW RELEASE	05-FEB-10	MRS	St.P

FOR FURTHER INFORMATION SEE DATA SHEET FOR
RN73 SERIES-HIGH PRECISION RESISTORS (SMD)

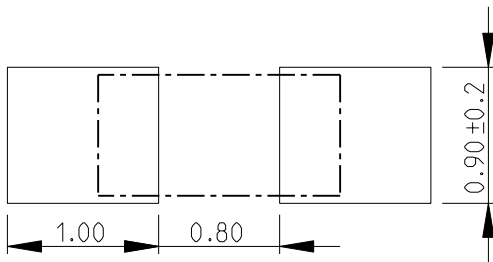
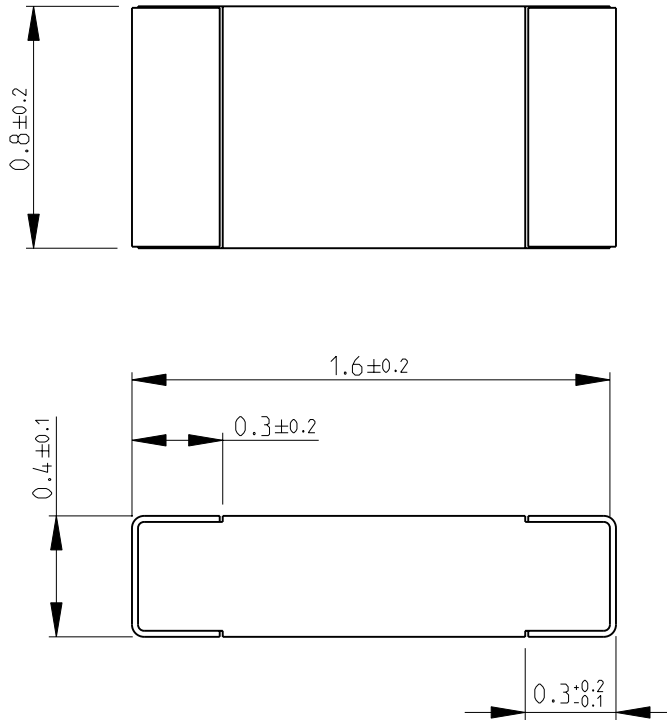

RECOMMENDED LAND PATTERN

RoHS Compliant

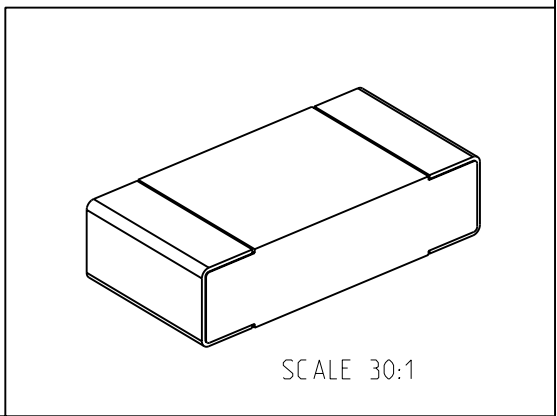

2010
 RELEASED FOR PUBLICATION
 THIS DRAWING IS UNPUBLISHED.
 BY TYCO ELECTRONICS CORPORATION. ALL RIGHTS RESERVED.
 COPYRIGHT 2010

DIMENSIONS: mm	DWN MAHARUDRA	05-FEB-10	MATERIAL	-	FINISH	-
	CHK ALLAN.P	05-FEB-10	Tyco Electronics Corporation Dorcan, Swindon, SN3 5HH			
TOLERANCES UNLESS OTHERWISE SPECIFIED:	APVD STEPHEN.P	05-FEB-10				
0 PLC ±0.2	PRODUCT SPEC	-	NAME HIGH PRECISION RESISTORS (SMD) SERIES RN73 1J			
1 PLC ±0.1	APPLICATION SPEC	-				
2 PLC ±	WEIGHT	-	SIZE	A 4	CAGE CODE	00779
3 PLC ±			DRAWING NO	C= 1614351		RESTRICTED TO
4 PLC ±						-
ANGLES ±5°						
			CUSTOMER DRAWING		SCALE	40:1
					SHEET	1 OF 1
					REV	BA