



All numerical values are in metric units [with U.S. customary units in brackets]. Dimensions are in millimeters. Figures and illustrations are for identification only and are not drawn to scale.

## 1. INTRODUCTION

This specification covers the requirements for application of the Industrial Din Rail Type Spring Clamp Terminal Block Connector Series in production and manufacturing environments. The connector series includes the products shown in table 1. All of the connectors in this product line are Din Rail Type Spring Clamp Terminal Block per UL1059

When corresponding with TE Connectivity Personnel, use the terminology provided in this specification to facilitate your inquiries for information. Basic terms and features of this product are provided in Figure 1.

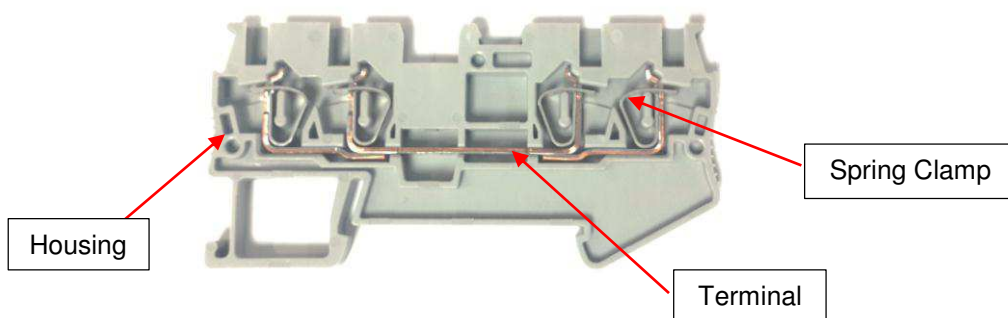

Figure 1

## 2. REFERENCE MATERIAL

### 2.1 Revision Summary

Initial release of document

### 2.2 Customer Assistance

Reference Product Base Part Numbers in TE's product C-drawing for every series. Use of these numbers will identify the product line and help you to obtain product and tooling information. Such information can be obtained through a local Representative, by visiting our website at [www.te.com](http://www.te.com), or by calling **PRODUCT INFORMATION** or the **TOOLING ASSISTANCE CENTER** at the numbers searched in the website.

### 2.3 Drawings

Customer Drawings for specific products are available from the responsible Engineering Department via the service network. The information contained in the Customer Drawings takes priority if there is a conflict with this specification or with any other technical documentation supplied by TE.

### 2.4 Specifications

Design Objective 108-137138 and 108-137142 provides expected test and performance requirements.

## 3. REQUIREMENTS

### 3.1 Safety

Do not stack product shipping containers so high that the containers buckle or deform.

### 3.2 Storage

#### A. Ultraviolet Light

Prolonged exposure to ultraviolet light may deteriorate the chemical composition used in the connector housings material.

#### B. Shelf Life

The connectors should remain in the shipping containers until ready for use to prevent deformation to those components. The components should be used on a first in, first out basis to avoid storage contamination that could adversely affect signal transmissions.

#### C. Chemical Exposure

Do not store connectors near any chemicals listed below as they may cause stress corrosion cracking in the contacts.

Alkalies/Ammonia Citrates/Phosphates Citrates/Sulfur Compounds  
Amines Carbonates Nitrites/Sulfur Nitrites/Tartrates

## 4. ASSEMBLY INSTRUCTION

Din rail spring type products and accessories should be assembled to rail when customer using them, below picture is the overview for the general assembly (see figure 2).

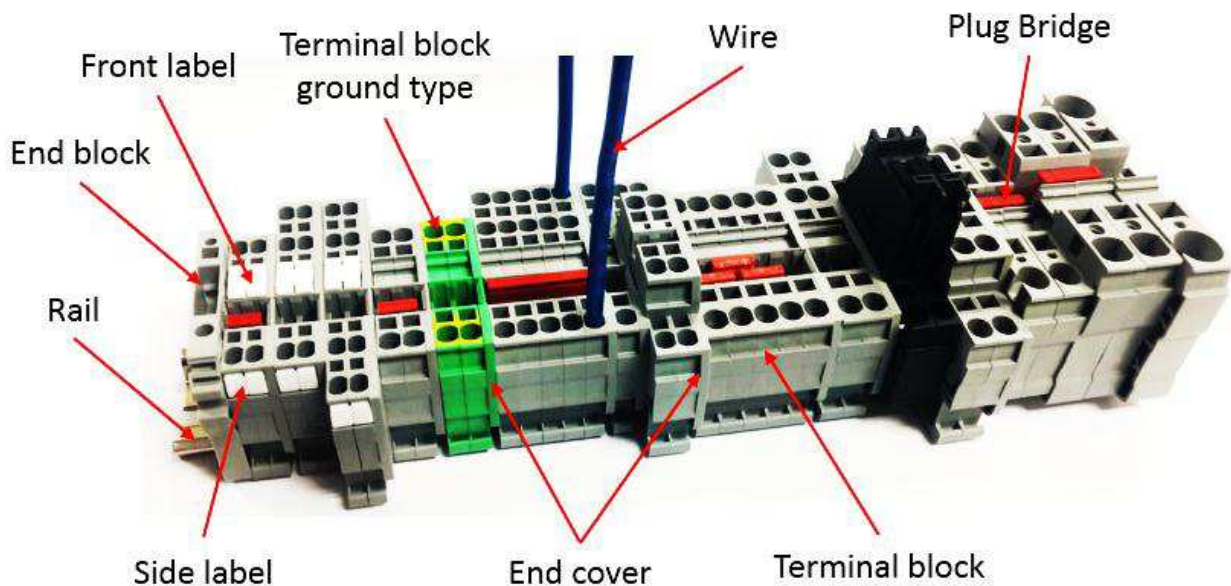

Figure 2

### 4.1 Wire Field Assembly

**The recommended wires which are applicable for spring terminal block should be solid wire or 7 stranded wire.**

#### A. Wire stripped

Selecting the wire of suitable size recommended in product customer drawing or the remark on product for Preprocessing as figure 3. The wire must be stripped the plastic, the length of bare wire should be follow table 1. The wire should have no sharp edges or corners that can damage conductor insulation with which it may come in contact.

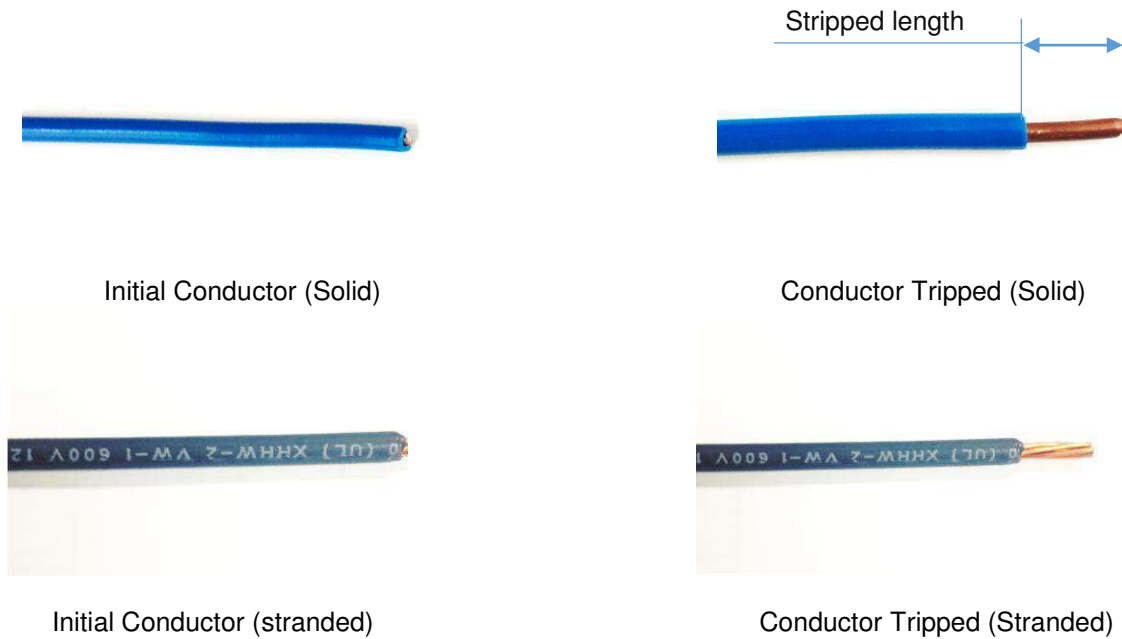

Figure 3 Wire stripped  
**Table 1 Wire stripped length**

Conductor Section	TE Product Series	Conductor Size Range (AWG)	Stripped length of Wire
1.5mm <sup>2</sup>	DTS1.5,DTS1.5*	28-14	8-10mm
2.5mm <sup>2</sup>	DTS2.5 ,DTS2.5*	28-12	8-10mm
4mm <sup>2</sup>	DTS4,DTS4*	28-10	8-10mm
6mm <sup>2</sup>	DTS6,DTS6*	24-8	10-12mm
10mm <sup>2</sup>	DTS10,DTS10*	24-6	16-18mm
16mm <sup>2</sup>	DTS16,DTS16*	24-4	16-18mm
35mm <sup>2</sup>	DTS35,DTS35*	14-2	25-27mm

B. Wire connection  
The detail function of the holes see Figure 4.1 & 4.2, tools see figure 5.

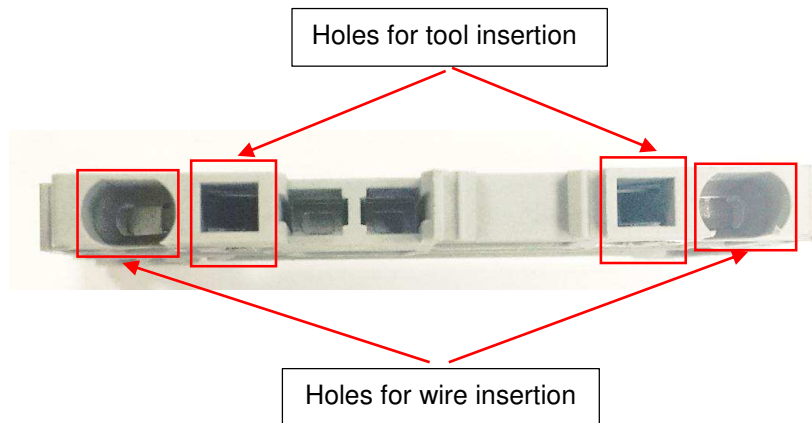

Figure 4.1

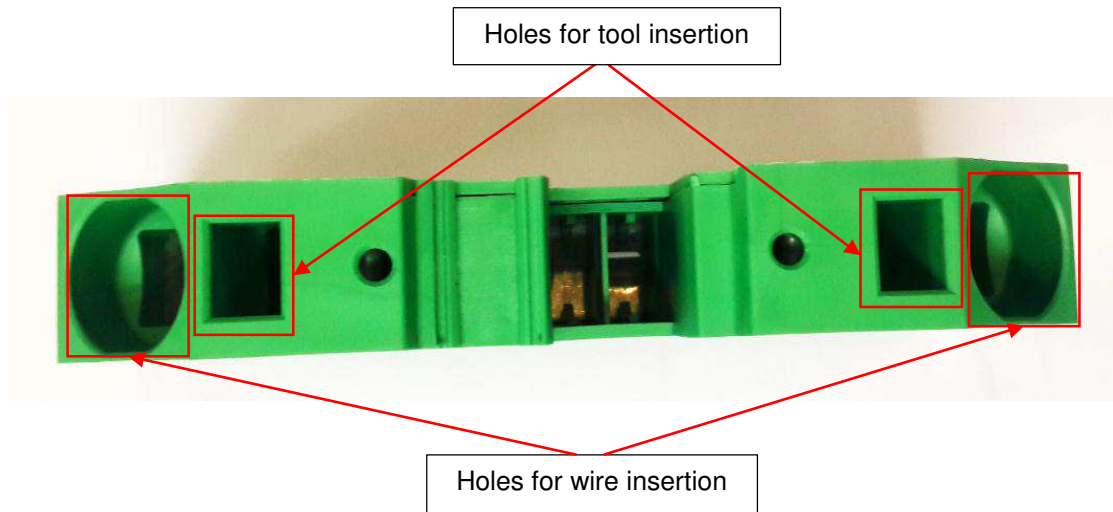

Figure 4.2

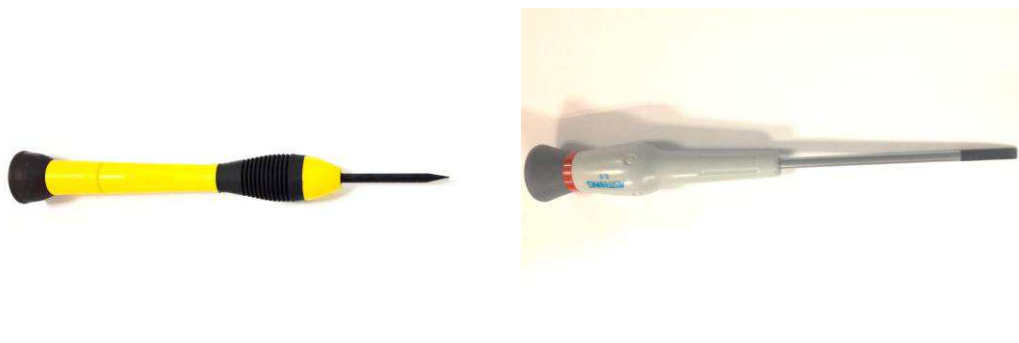

Figure 5 Tools

After finishing stripping the conductor, then insert the conductor into the hole of clamp using the tool, detail conductor connection process see below steps: (Figure 6.1):

- 1> Insert the tool into the right hole for tools insertion
- 2> Insert the tool to the bottom of the hole of terminal block
- 3> Press the spring clamp to provide enough space for wire insertion
- 4> Inserting the wire to the bottom of connection hole of spring clamp completely
- 5> Pull out the tool from the hole of product



Step1

Step2

Din Rail Type  
 Spring Clamp Terminal Block



Figure 6.1 Wire connection

For 35mm<sup>2</sup> product DTS 35 and DTS 35-G, the conductor should follow below steps, detail see figure 6.2:

- 1> Inserting the tool into the hole;
- 2> Give a lateral force to the tool hand shank to make the spring of product release a space for wire inserting
- 3> Inserting the conductor
- 4> Removing the tool

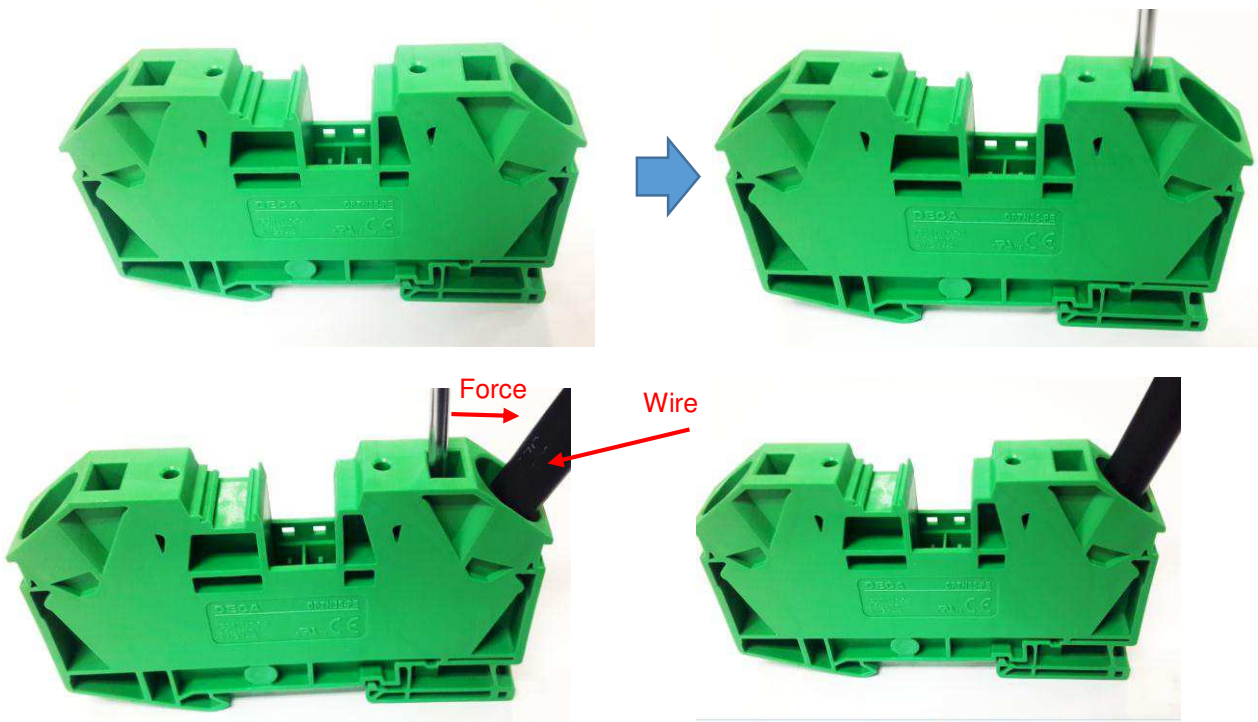

Figure 6.2

Din Rail Type  
**Spring Clamp Terminal Block**

Follow the same steps, insert other conductors into the other holes of clamps (figure 7), then inspect the connection of conductor to ensure the wire is connected correctly.

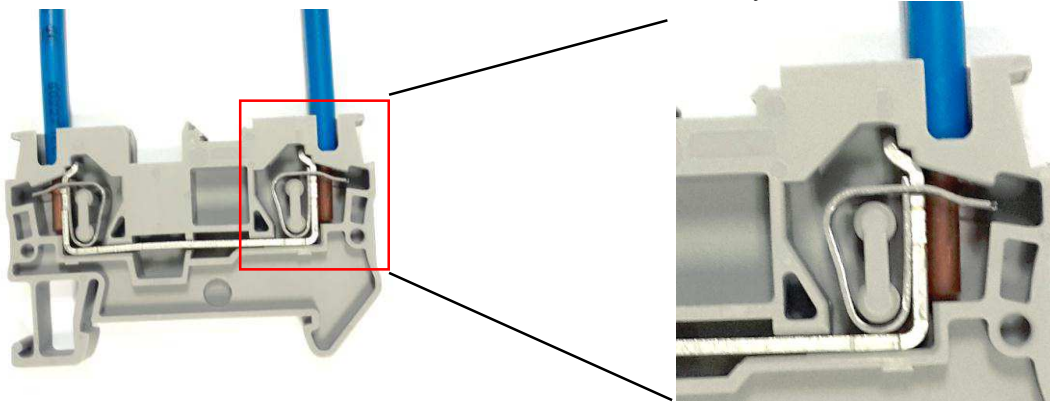
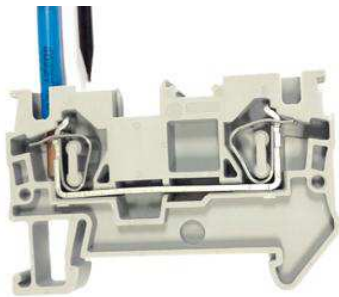

Figure 7

C. Wire removing

Using the suitable tool to removing the wire. Detail process should refer to below steps(see figure 8.1):

- 1>Insert the tool into the right hole for tools insertion
- 2>Insert the tool to the bottom of the hole of terminal block
- 3>Press the spring clamp to loose the wire and then pull the wire
- 4>Pull out the wire from the connection hole of product completely
- 5> Pull out the tool from the hole of product



Step 1



Step 2

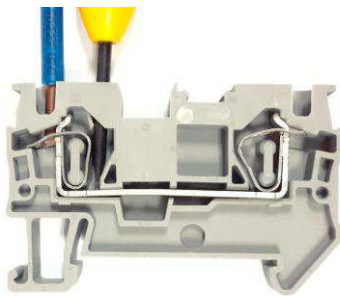

Step 3

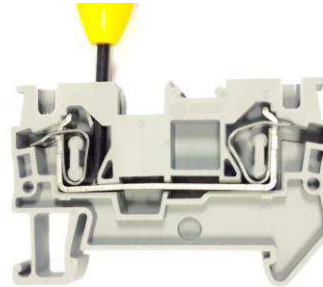

step 4

Din Rail Type  
 Spring Clamp Terminal Block



Step 5

Figure 8.1 Wire removing

For 35mm<sup>2</sup> product DTS 35 and DTS 35-G, the conductor removing should follow below steps, detail see figure 8.2:

- 1> Insert the tool into the hole for tool insertion
- 2> Give a lateral force to the tool hand shank towards to conductor
- 3> Pull the conductor from the product
- 4> Pull the tool from the product

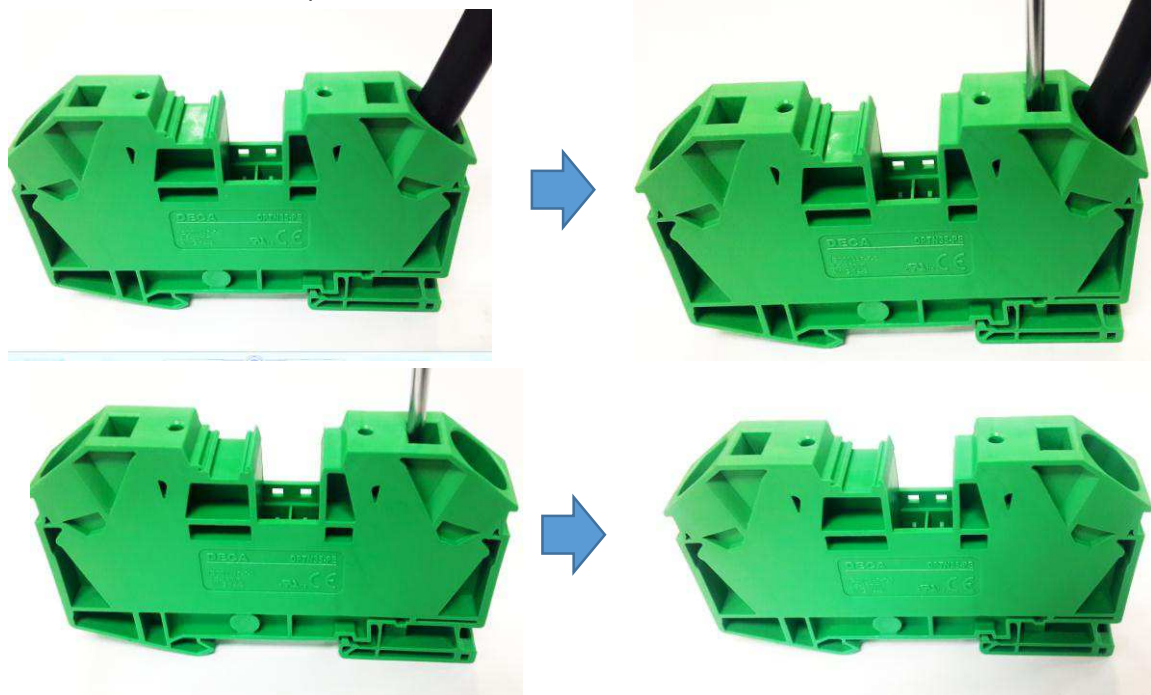

Figure 8.2 Wire removing

#### 4.2 Products fixing to Din rail and removing

Products includes terminal block connectors and end block need to assembly to DIN rail.

The recommended mounting Din Rail should be TE product 2271573-1/2271573-2 or the rail meet IEC60715 standard.

##### A. Terminal block connector fixing to Din Rail.

For terminal block product, the fixing process of product to Din rail should follow below steps (see figure 9):

- 1> Inserting the rail edge into the right side of product latching space which has no elasticity.
- 2> Pressing the product to make the left latch which has elasticity lock the rail.

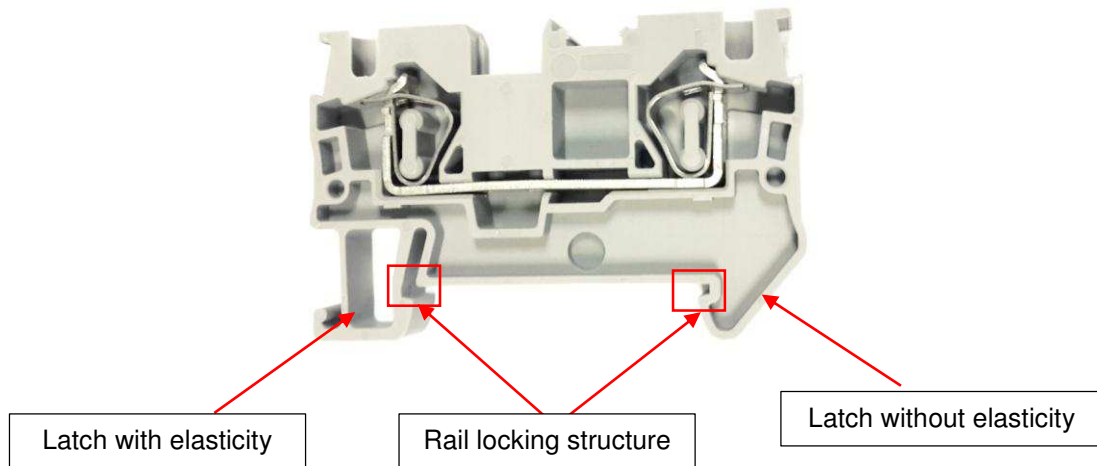

Terminal block without ground function

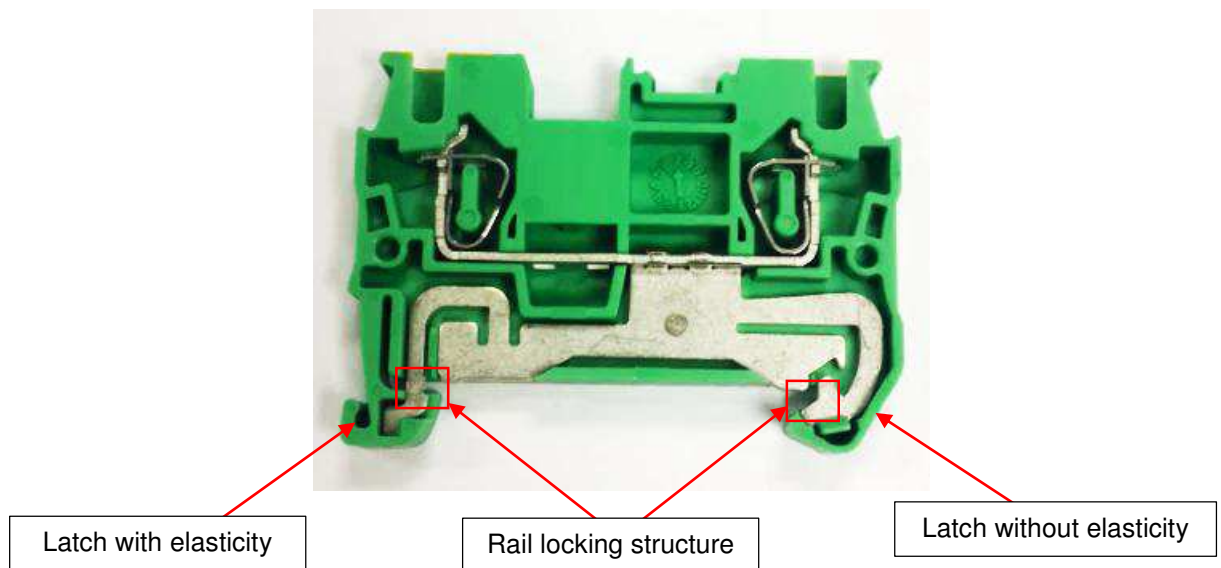

Terminal block with ground function



Din Rail Type  
 Spring Clamp Terminal Block

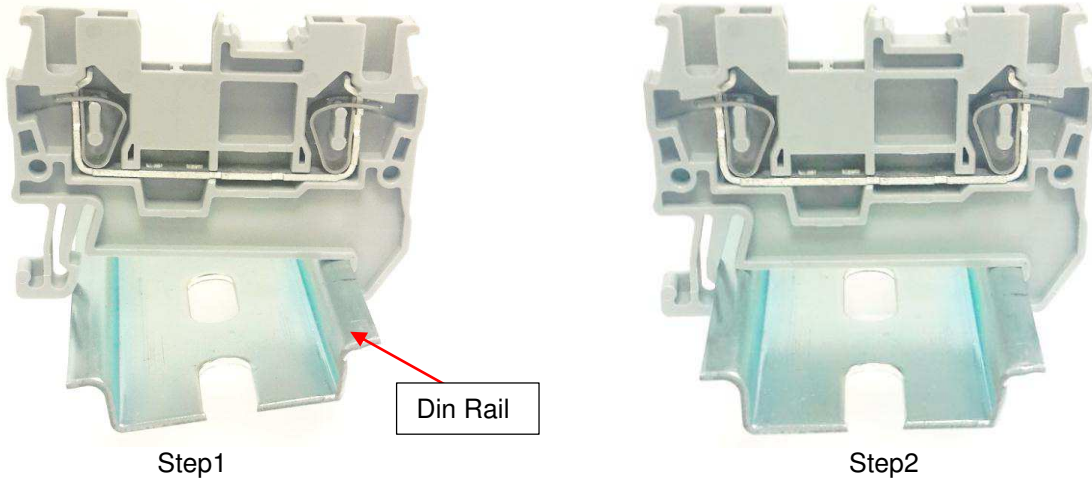

Figure 9.1 Product (without ground function) fixing to Din Rail

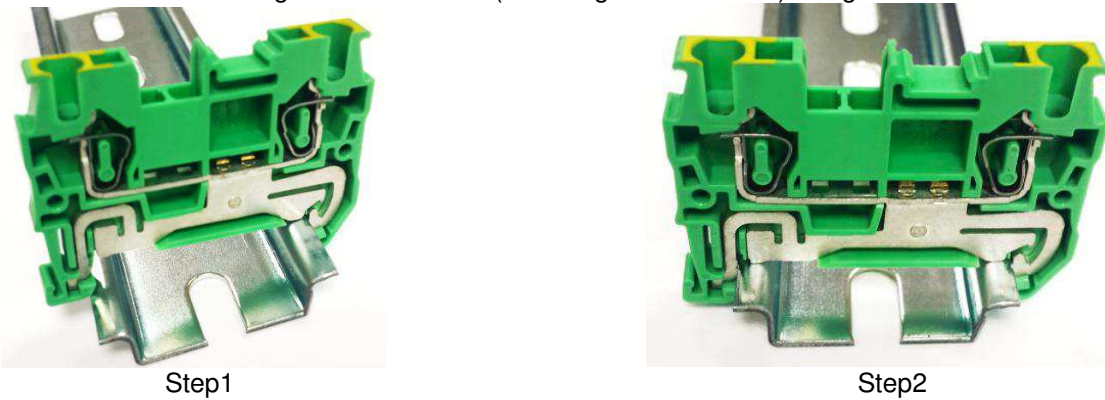

Figure 9.2 Product (with ground function) fixing to Din Rail

**B. Products removing from Din Rail.**

For terminal block removing from Din Rail, below instruction will help to operate it more conveniently and effectively.

Using the applicable tool to give a proper lateral force to the elastic latch and loosen it from the rail, detail see figure 10:

Din Rail Type  
Spring Clamp Terminal Block

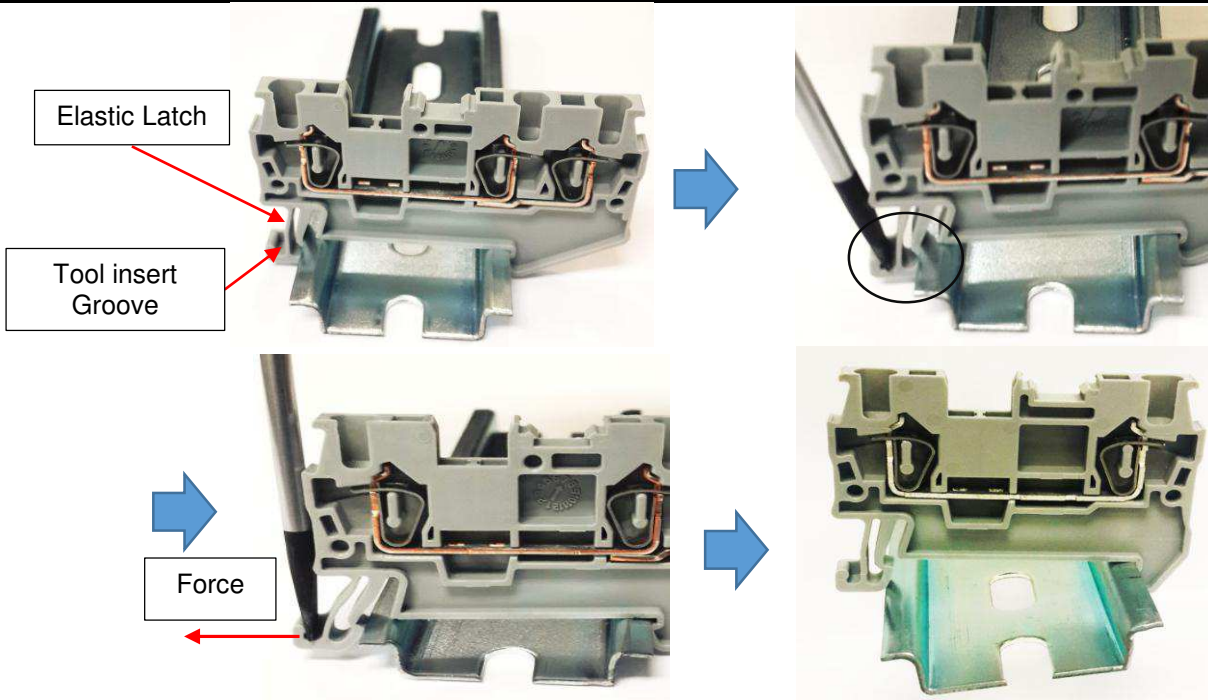

Figure 10.1 Product (without ground function) removing from Rail

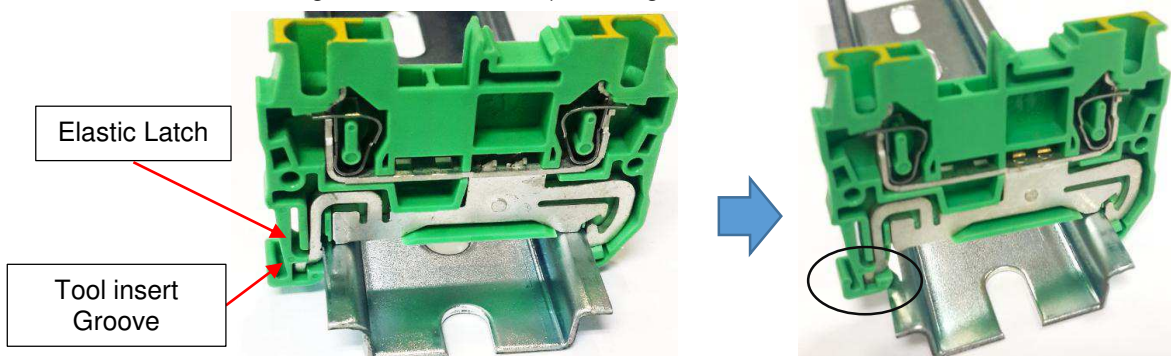
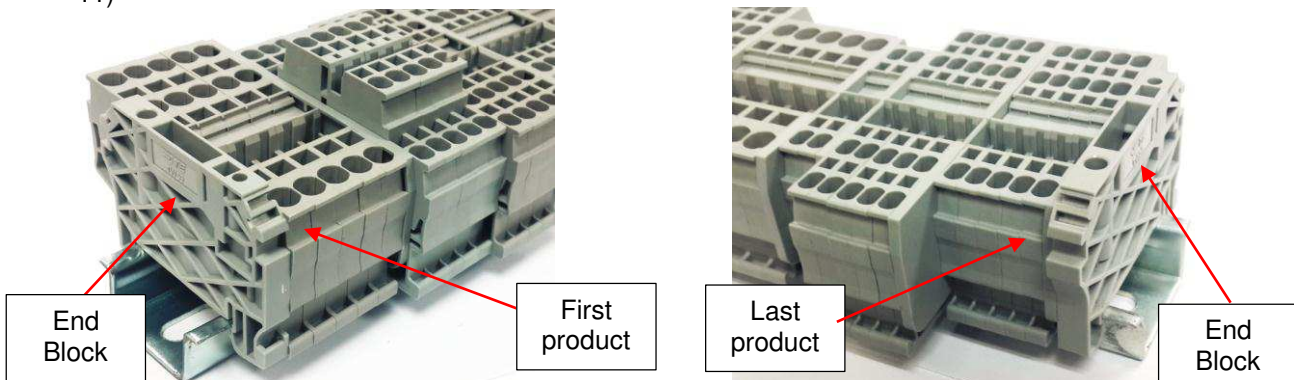

Figure 10.2 Product (with ground function) removing from Rail

#### 4.3 End block usage instruction

##### A. End block fixing to rail

End block product has the function of limiting terminal block products on rail, makes them fixed on rail stably, and avoid the unnecessary movements of products. When user finish loading terminal blocks on rail, it should take end blocks to fixing on the each ends of rail leaning against the first and last product on rail (see figure 11)



Din Rail Type  
Spring Clamp Terminal Block

Figure 11

For end block, the fixing process of product to Din rail should follow below steps (see figure 12):  
1>Inserting the rail edge into the left side space of product latch space which has no elasticity.  
2>Pressing the end block to make the right latch which has elasticity lock the rail.

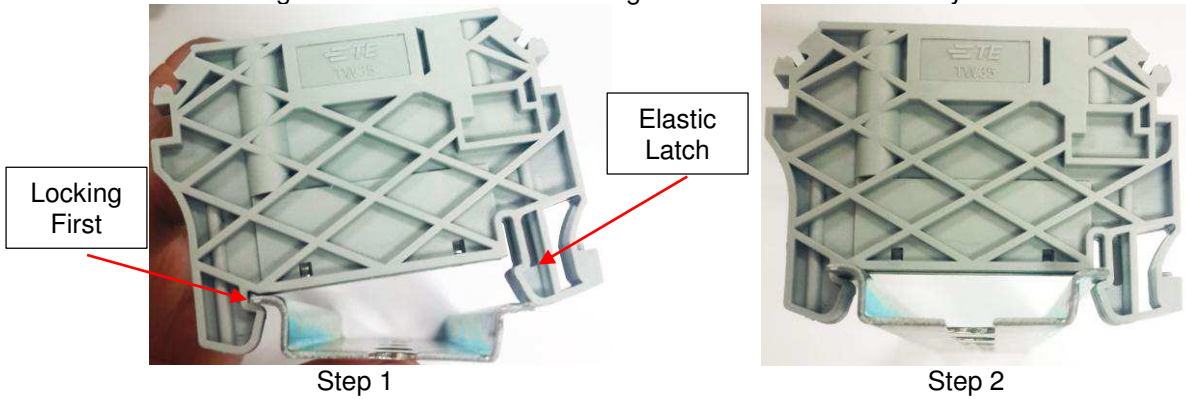

Figure 12 End block fixing to rail

B. For end block removing from Din Rail, below instruction will help to operate it more conveniently and effectively.

Using the applicable tool to unclench the elastic latch and loosen it from the rail, detail see figure 13:

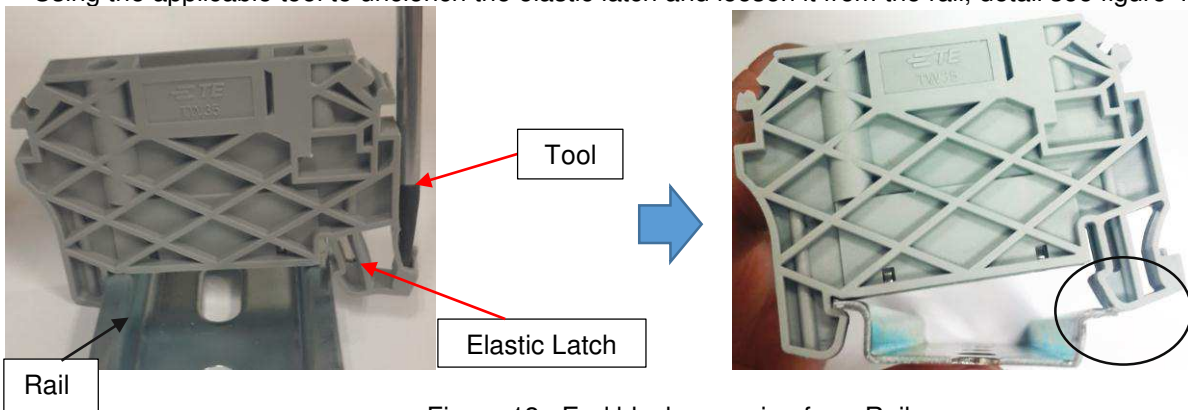

Figure 13 End block removing from Rail

**4.4 Plug bridge use instruction.**

TE has many series plug bridge products, each series are applicable different terminal block products. Customer should refer to table 2 to select correct plug bridge for really application.

Table 2 Plug bridge

Plug Bridge Part Number	Plug Bridge Series	Continuous Current	Applicable Product Series (Wire section)
2271568-*	TFBS*-4	15A	1.5mm <sup>2</sup> series
2271569-*	TFBS*-5	20A	2.5mm <sup>2</sup> series
2271570-*	TFBS*-6	30A	4mm <sup>2</sup> series
2271621-*	TFBS*-8	45A	6mm <sup>2</sup> series
2271622-*	TFBS*-10	65A	10mm <sup>2</sup> series
2271623-*	TFBS*-12	65A	16mm <sup>2</sup> series
2271624-*	TFBS*-16	115A	35mm <sup>2</sup> series

Din Rail Type  
 Spring Clamp Terminal Block

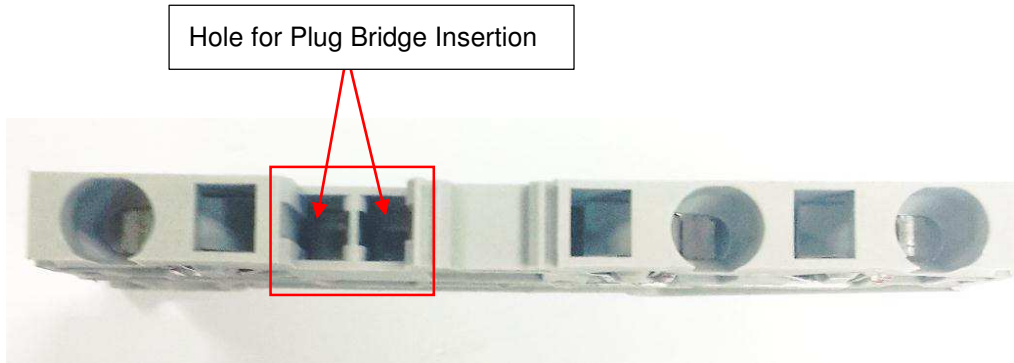

Figure 14.1 Hole of product for bridge insertion

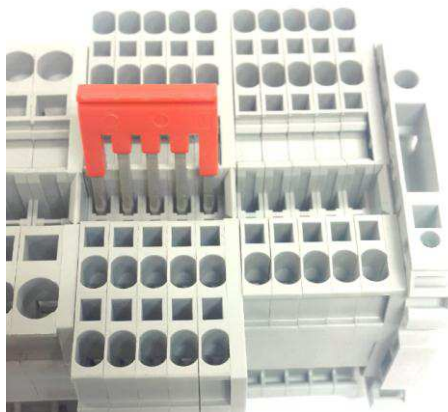

Figure 14.2 Plug bridge

A. Plug Bridge fixing to product.

As shown on figure 14, each terminal block product have holes for plug bridge insertion, so if we selection the applicable plug bridge meeting the requirements, then insert the contact to two or more adjacent terminal block products following below steps to connect the related products together(See figure 15).

- 1> Select the plug bridge with two positions or more positions, ensure their electrical parameters are correct;
- 2> Inserting the contacts of plug bridge into the hole of terminal block which for plug bridge insertion;
- 3> Pressing the top surface of plug bridge and make it insert deep to the hole, when the top surface is Getting the same height as the product top surface and reactive force is very large, this means the plug bridge is on its working position.



Step 1

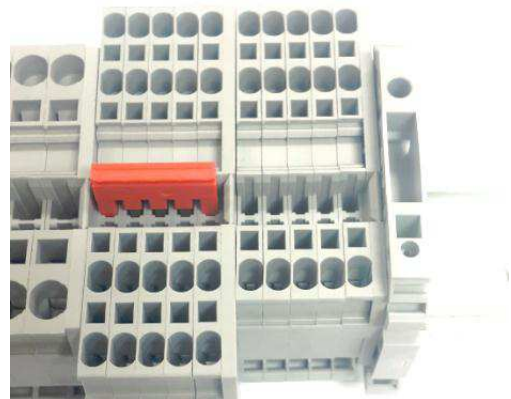

Step 2

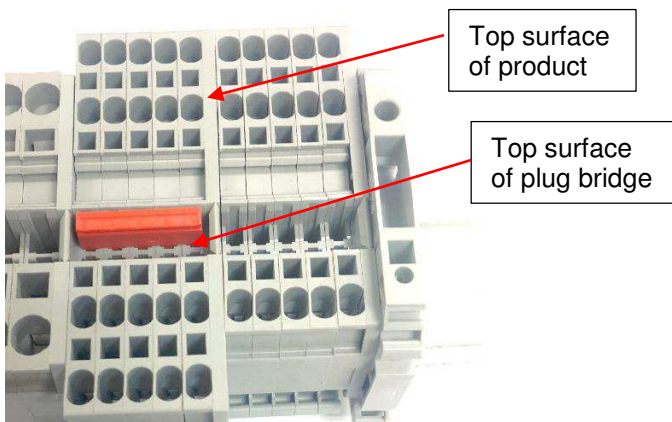

Step 3

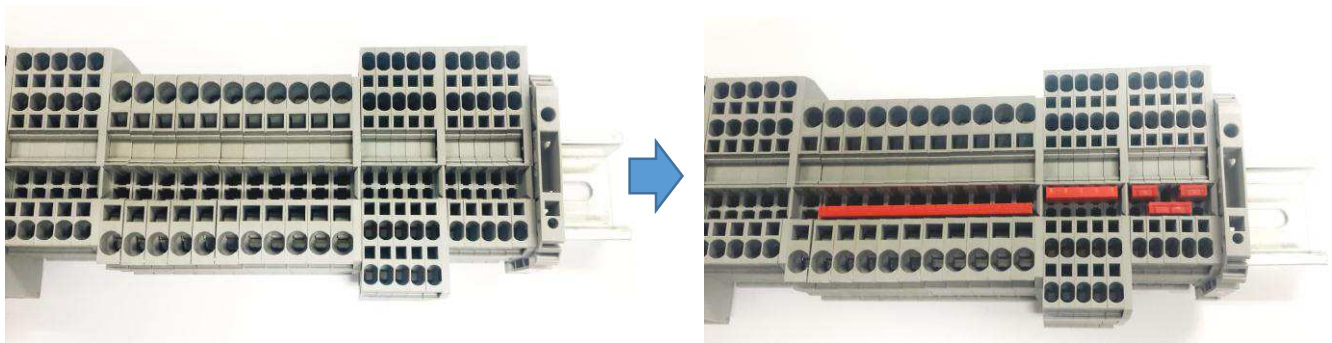
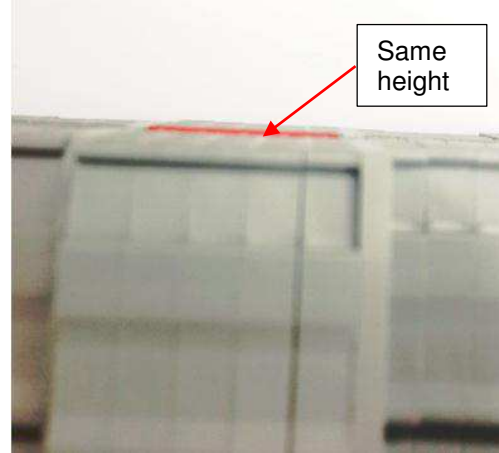
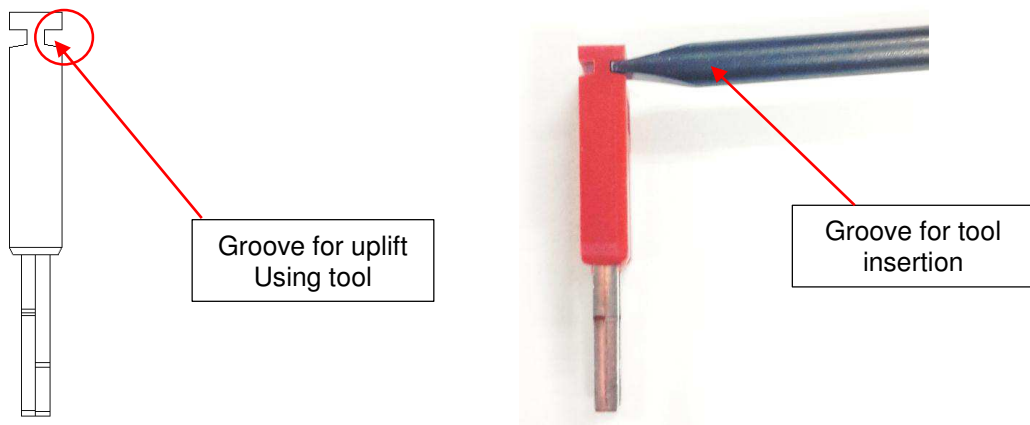

Figure 15

**B. Plug Bridge removing from product.**

If the users need to remove the plug bridge from the products, it is necessary to use tools. Taking appropriate tool and insert the end of tool into the groove of plug bridge, then pry up it from the product. It is very necessary to pry up the plug bridge on its two ends alternately, this will make it uplift step by step and more balanced, and avoid damaging the products and the plug bridges (see figure 16).



Din Rail Type  
 Spring Clamp Terminal Block

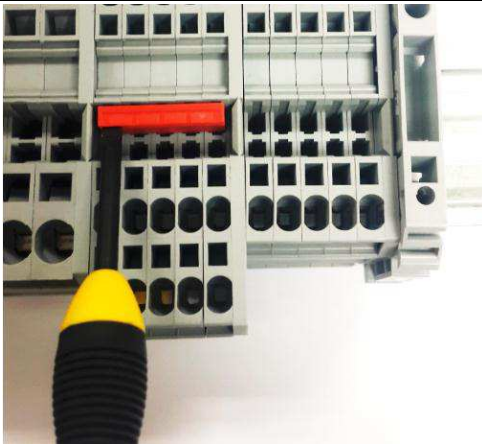

Step 1

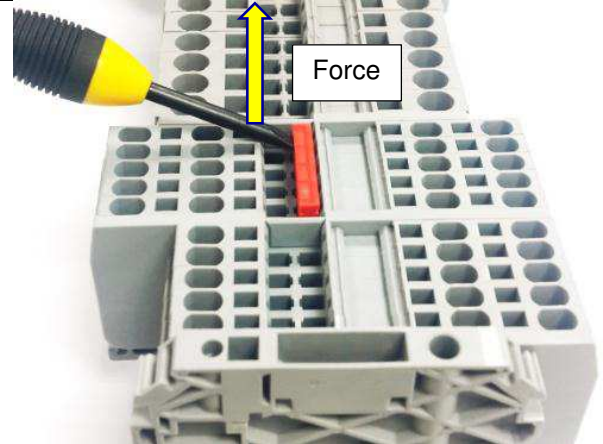

Step 2

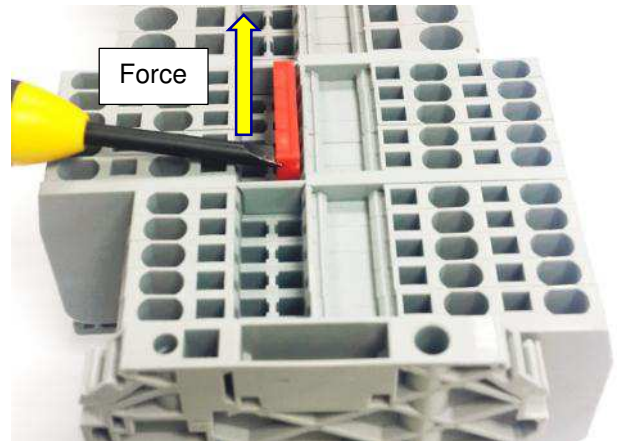

Step 3

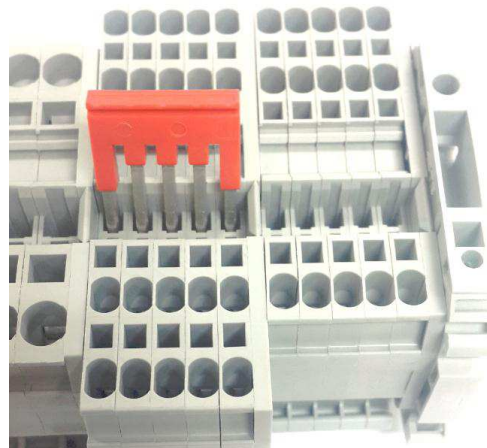

Figure 16 Plug Bridge removing

**4.5 End cover use instruction**

End cover provide insulation function and severance function for different series products on Din rail.  
 Shown as below picture (figure 17):

Din Rail Type  
 Spring Clamp Terminal Block

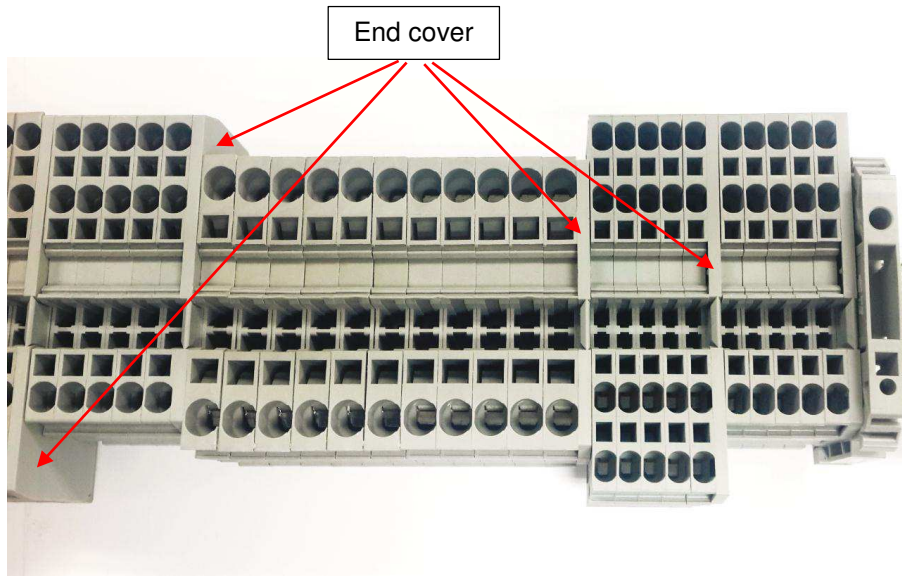

Figure 17

Cover mounting to product should make sure to press the posts of end cover into the holes of terminal block product, detail shown as below (see figure 18):

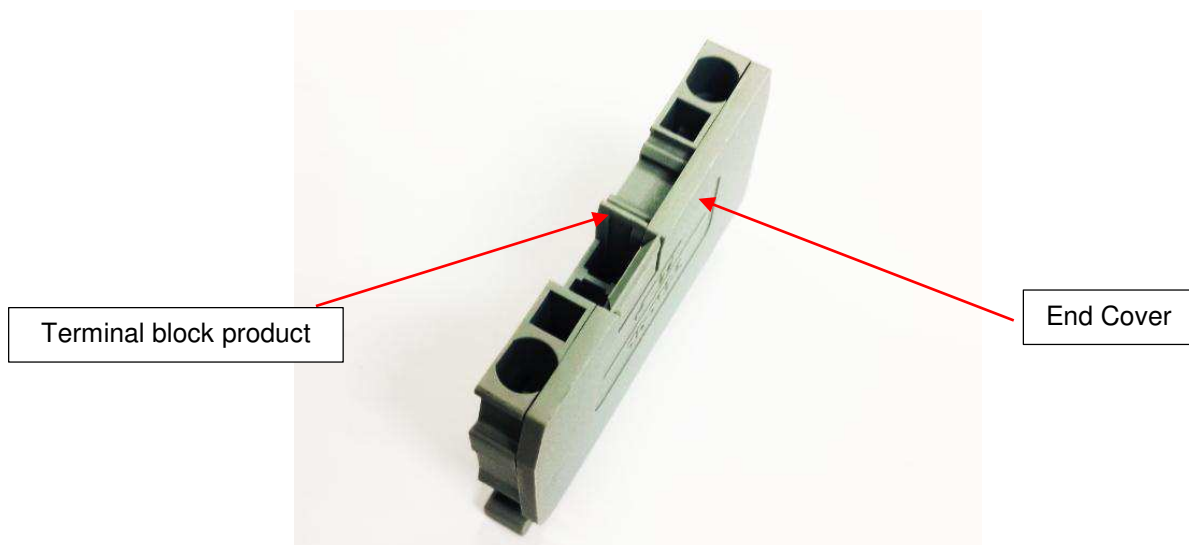
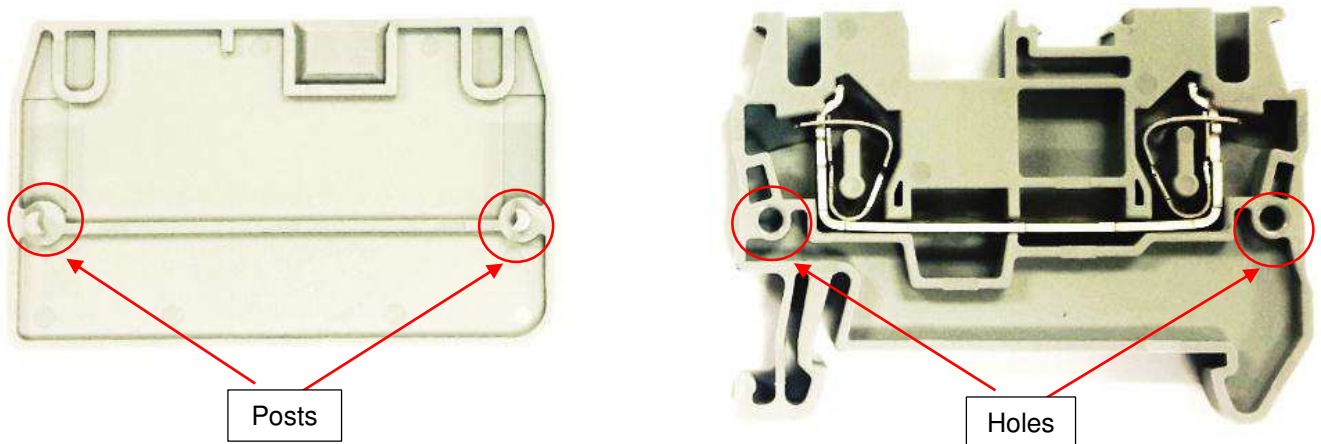
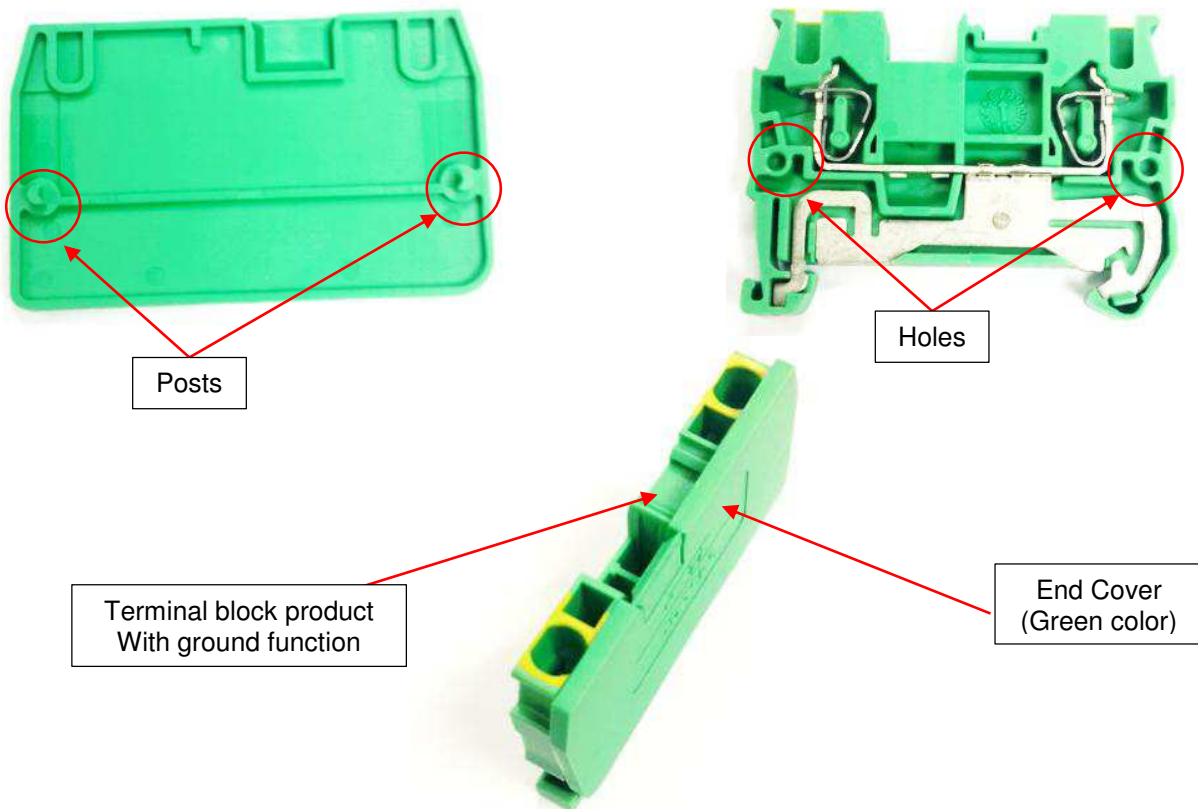

Figure 18

Din Rail Type  
Spring Clamp Terminal Block

08Aug2017 Rev.A3

For terminal block with ground function, end cover should select the related green color type for them.  
Detail see figure 19.



**Figure 19**

If need to separate the cover from the product, it is very easy to operate it. It only need to add a pull force on the correct area of end cover pointed as shown (see figure 20)

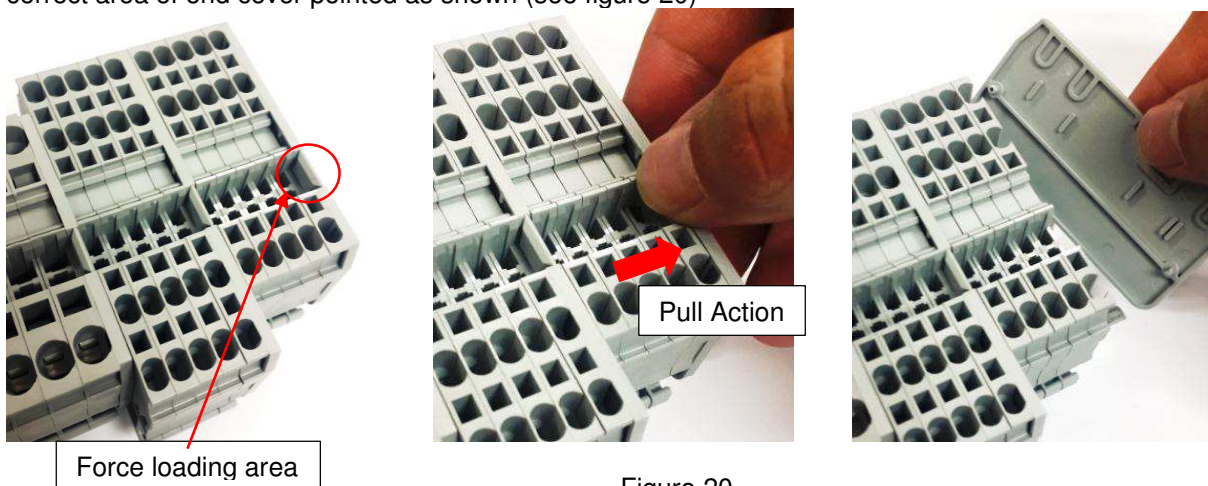

**Figure 20**

**4.6 Side label and front label usage instruction**

All the label should be selected following table 3 to ensure the labels meet the requirements of user. Before fixing to products, the label should finish printing the Arabic numerals or other comments needed using professional printer machine (see figure21).



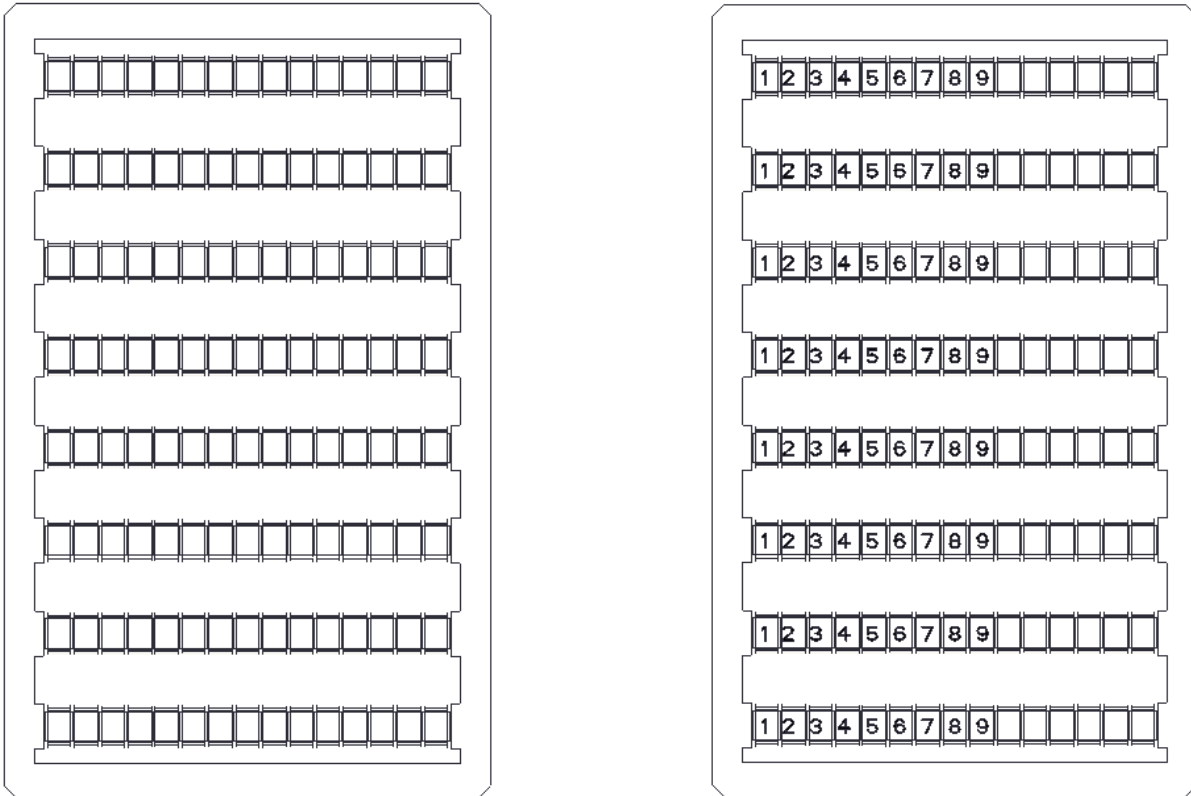

Figure 21.1 Side Label printing

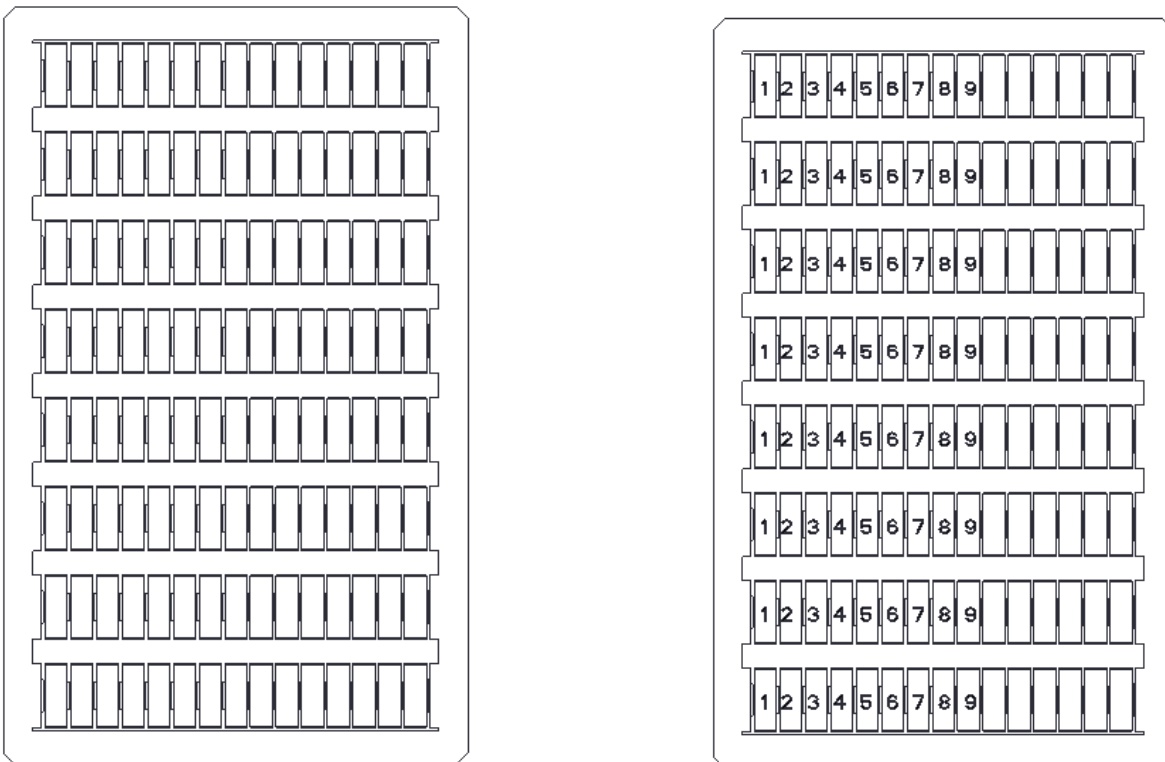

Figure 21.2 Front Side Label printing

Din Rail Type  
 Spring Clamp Terminal Block

Table 3 Label List

Type	TE Series	Applicable product series (Wire section)	Part Number
Side Label	TUC-TMF4	1.5mm <sup>2</sup>	2271571-1
	TUC-TMF5	2.5mm <sup>2</sup>	2271571-2
	TUC-TMF6	4mm <sup>2</sup>	2271571-3
	TUC-TMF8	6mm <sup>2</sup>	2271571-4
	TUC-TMF10	10mm <sup>2</sup>	2271571-5
	TUC-TMF12	16mm <sup>2</sup>	2271571-6
	TUC-TMF16	35mm <sup>2</sup>	2271571-7
Front Label	TUC-TM4	1.5mm <sup>2</sup>	2271572-1
	TUC-TM5	2.5mm <sup>2</sup>	2271572-2
	TUC-TM6	4mm <sup>2</sup>	2271572-3
	TUC-TM8	6mm <sup>2</sup>	2271572-4
	TUC-TM10	10mm <sup>2</sup>	2271572-5
	TUC-TM12	16mm <sup>2</sup>	2271572-6
	TUC-TM16	35mm <sup>2</sup>	2271572-7

After printing the required marking, take the suitable number of labels to fixing to the product assembled on the rail leaning against each other. The latches must put into the groove, detail see figure 22

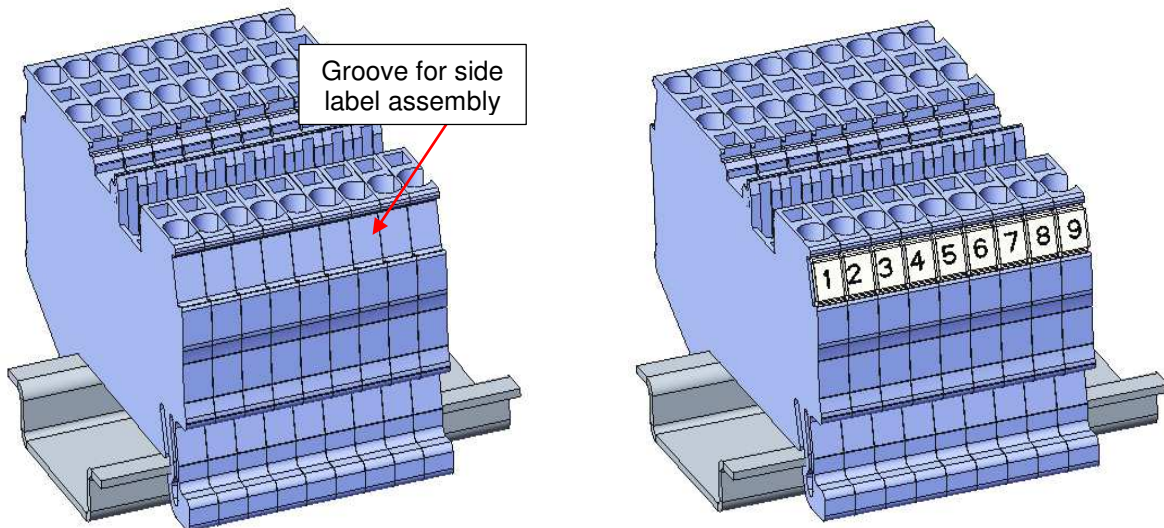



Figure 22.1 Side label fixing

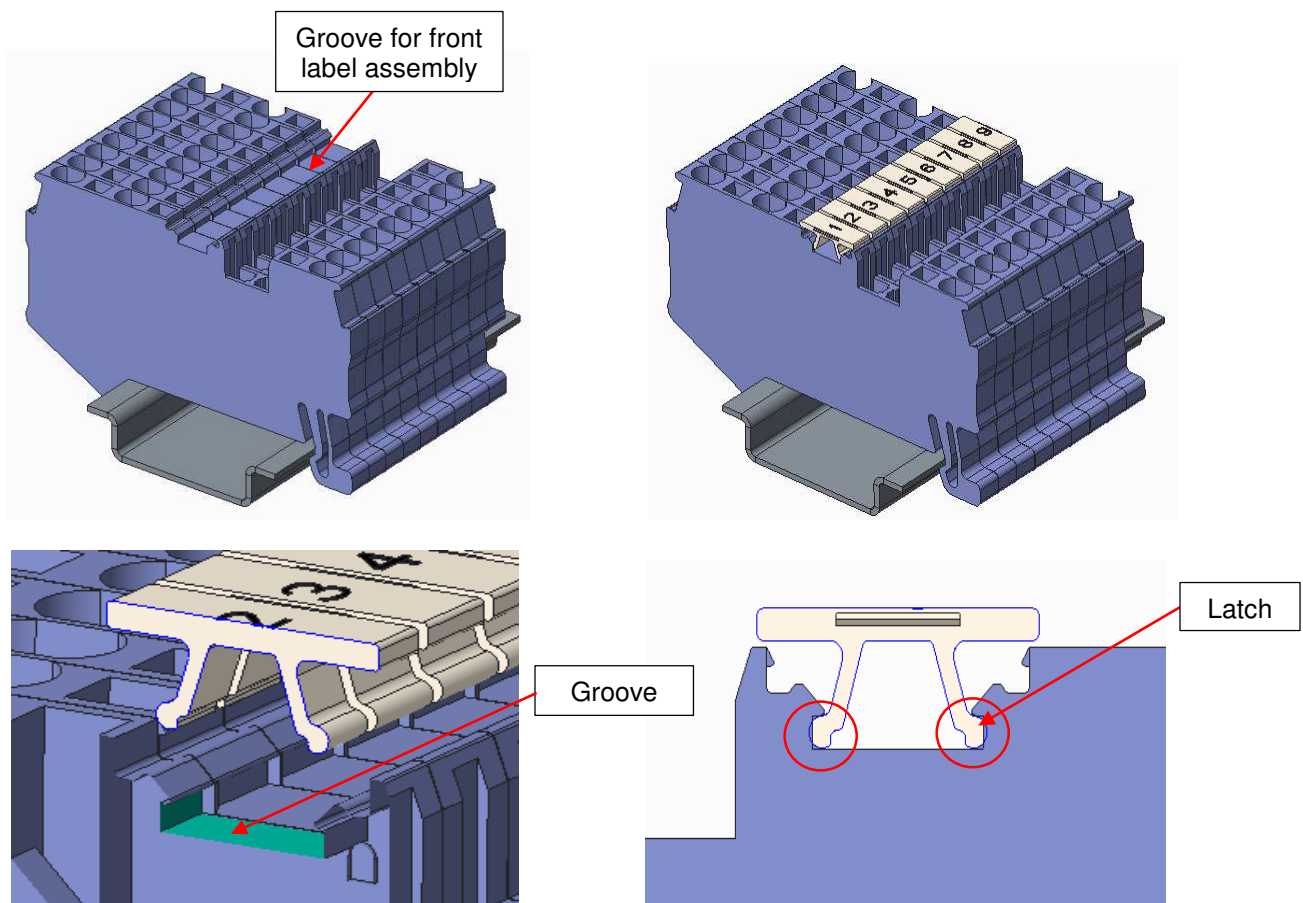

Figure 22.2 Side label fixing

**4.7 Fuse type terminal block usage instruction**

Fuse type (with LED) spring terminal block is a special type terminal block. Its rated current should follow fuse's specification. Its rated Voltage should follow LED's specification, Detail see the mark area shown in figure 23.

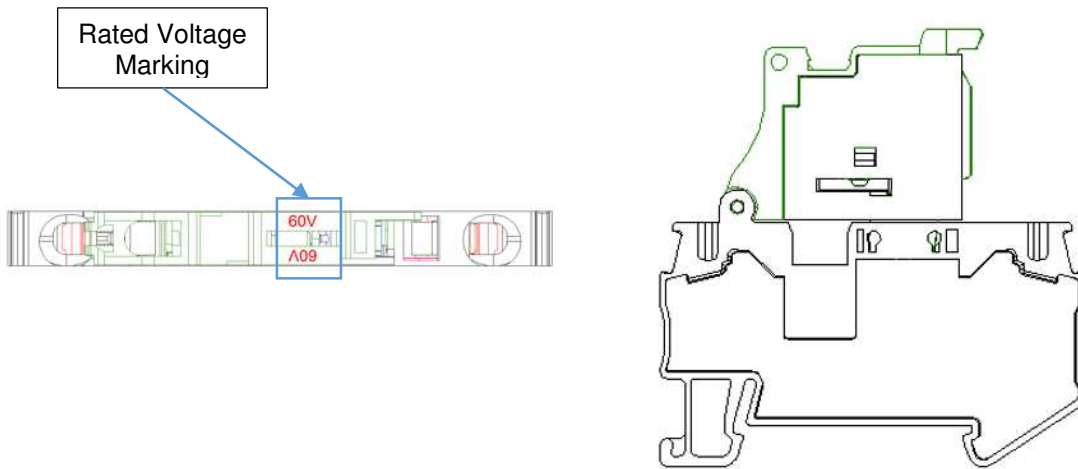
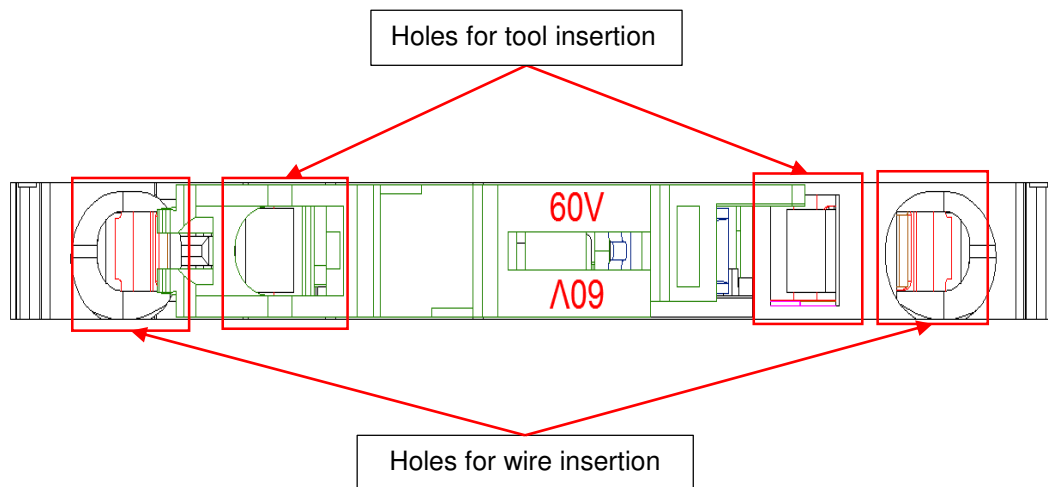

Figure 23

Fuse type terminal block have the same holes structures as other types terminal block connectors for wire insertion and connection, tooling insertion, and for plug bridge insertion & connection.



When need to insertion plug bridges, Fuse type terminal block connectors should open the Switch Module, Then insert the related plug bridge into the correct holes, detail see figure 24.



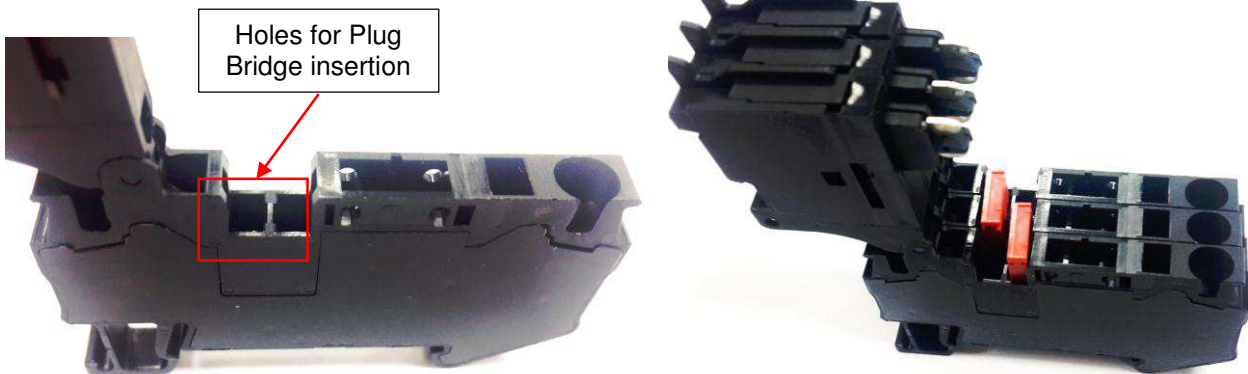
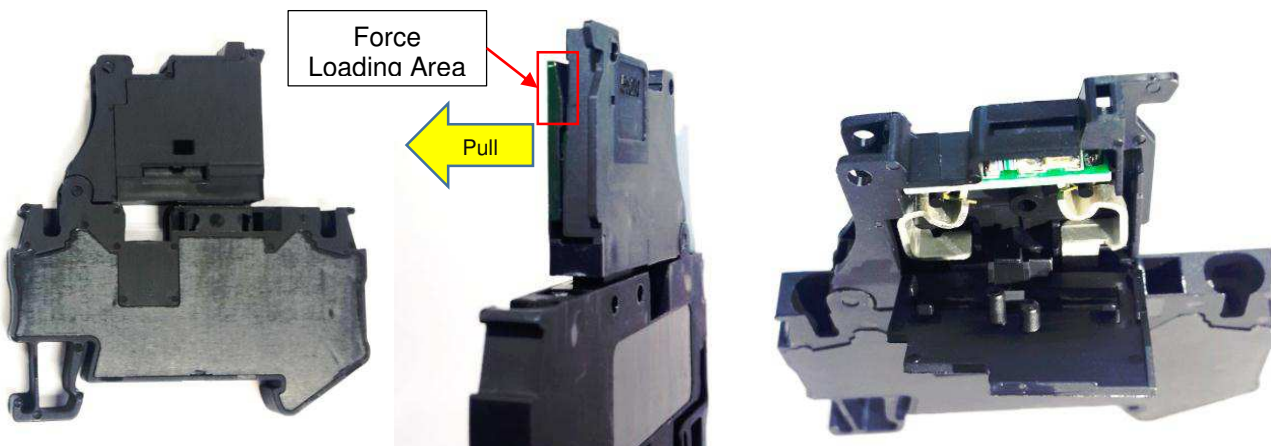

Figure 24

When customer using the fuse (G/5X20) to fix to product, below steps should be followed, detail see figure 25 for reference:

- 1> Open the cover of Switch module;
- 2> Insert the fuse into the space for holding the fuse of product
- 3> Press and close the cover.



Step 1

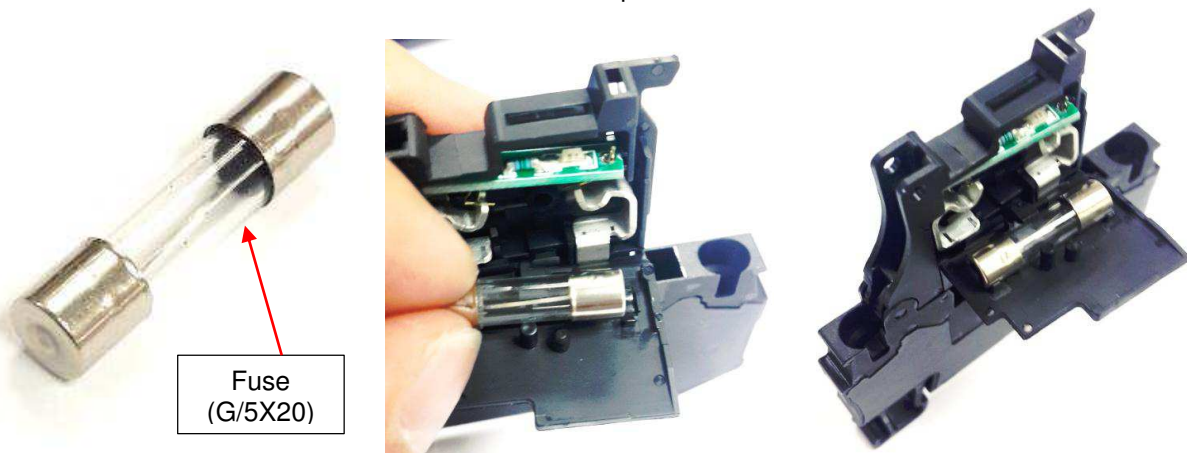

Step 2

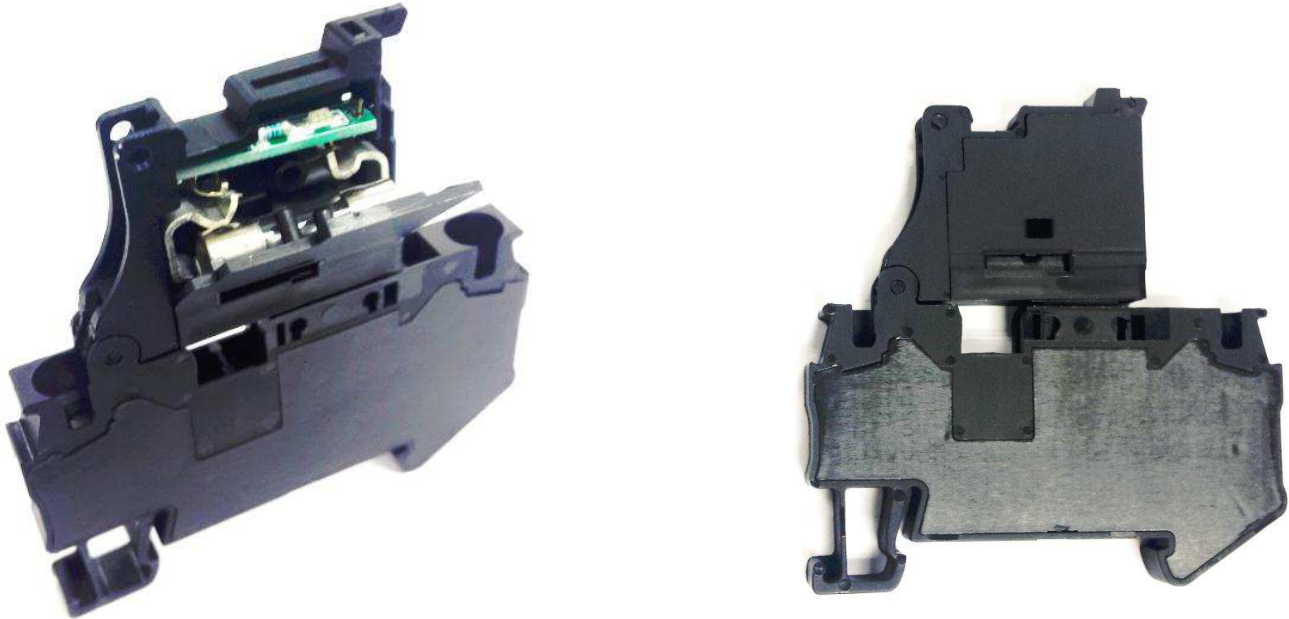

Step 3

Figure 25 Fuse Assembly

#### 4.8 Combine type terminal block usage instruction DTS 2.5/1P and DTS 2.5 PG)

A> Wire connection for DTS 2.5/1P and DTS 2.5 PG:

The conductor fixing process is same as other products ,detail see Figure 26

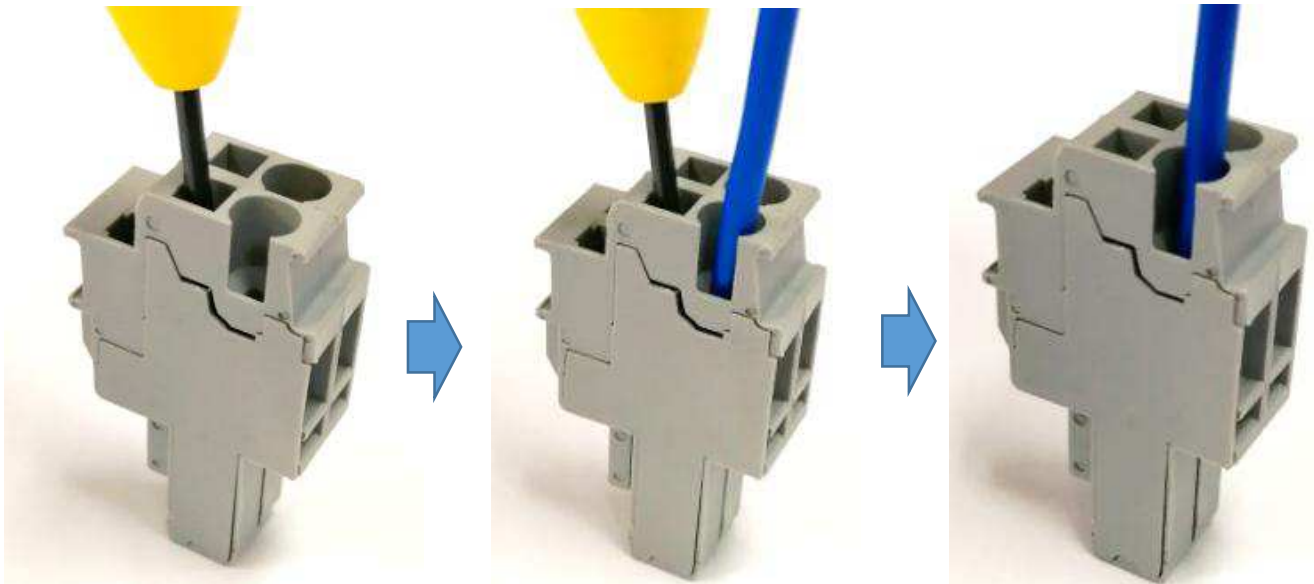

Figure 26.1 Wire connection for DTS 2.5 PG

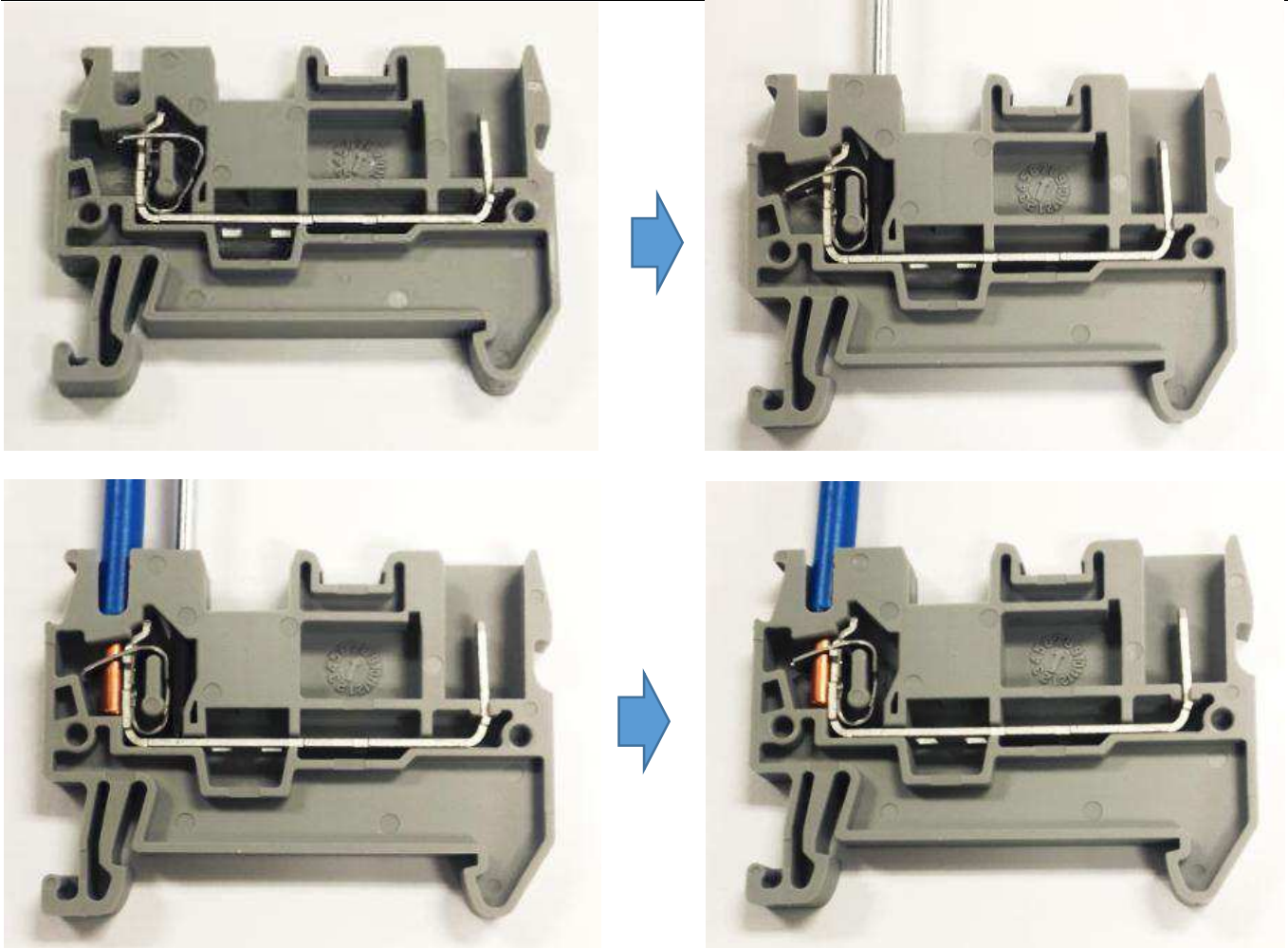
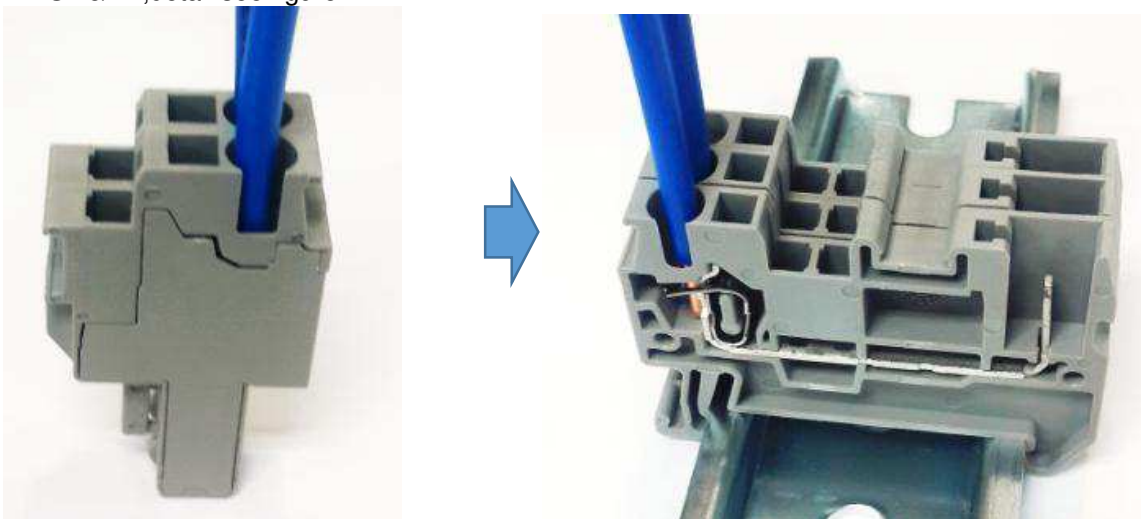

Figure 26.2 Wire connection for DTS 2.5/1P

- B> DTS 2.5 PG fixing to and removing from product DTS 2.5/1P  
When DTS 2.5 PG and DTS 2.5/1P finish connecting conductor, DTS2.5 PG should fixing to product DTS2.5/1P, detail see figure 27:



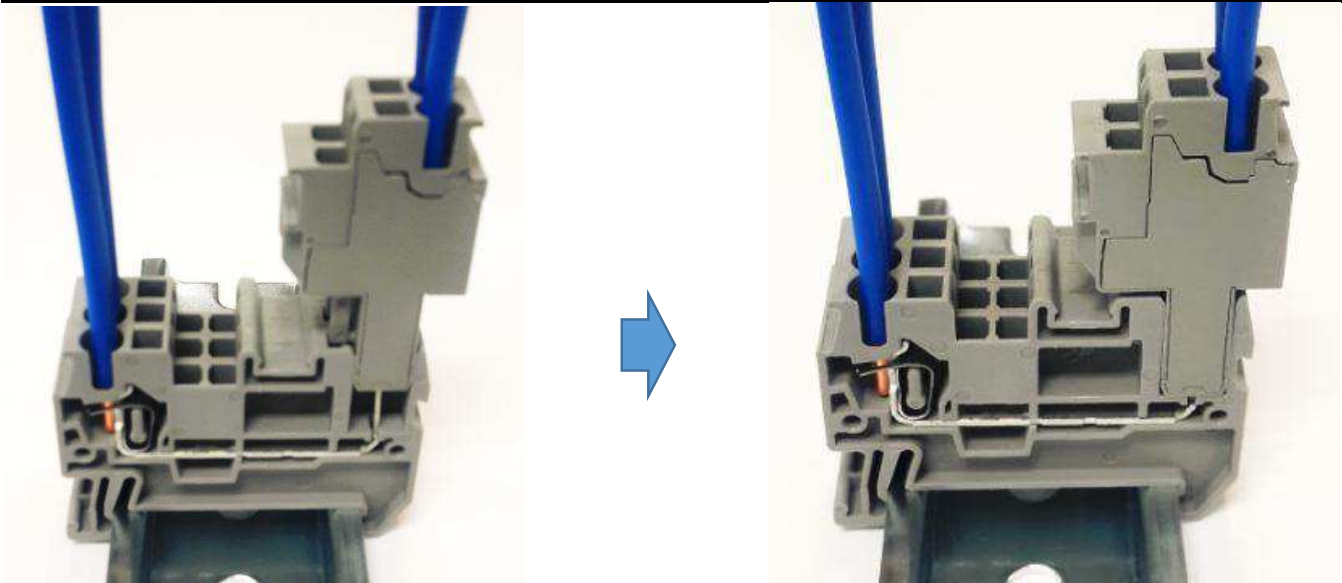

Figure 27 DTS2.5/1P and DTS 2.5 PG fixing

If need to remove DTS2.5 PG from product DTS 2.5/1P, it only need operate it conversely.

**4.9 DTS2.5 PG fixing spring and Wire locking spring usage:**



DTS 2.5 PG fixing spring



Wire locking spring

**Figure 28**

When DTS 2.5 PG fixed to product DTS 2.5/1P, if needed, the component-DTS 2.5 PG fixing spring can be used for supporting to increase the mating stability of DTS 2.5 PG.

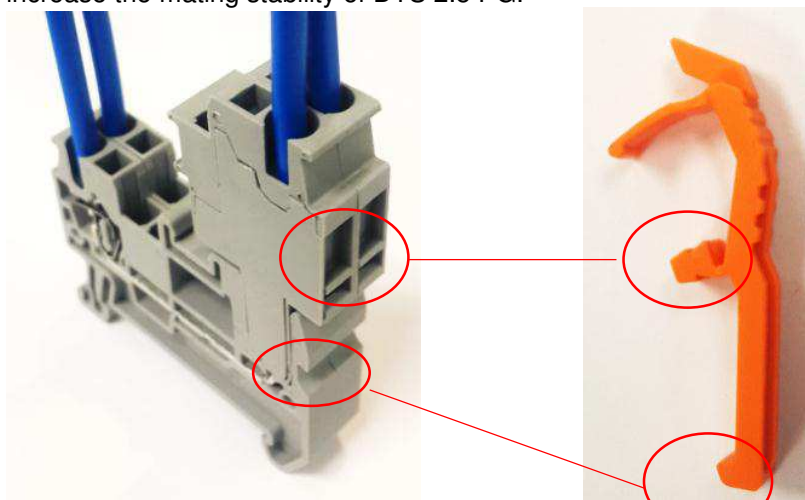

Figure 29



Din Rail Type  
**Spring Clamp Terminal Block**

The Fixing spring mating feature should insert related hole or groove, shown as above picture (figure 29),detail fixing process see figure 30:

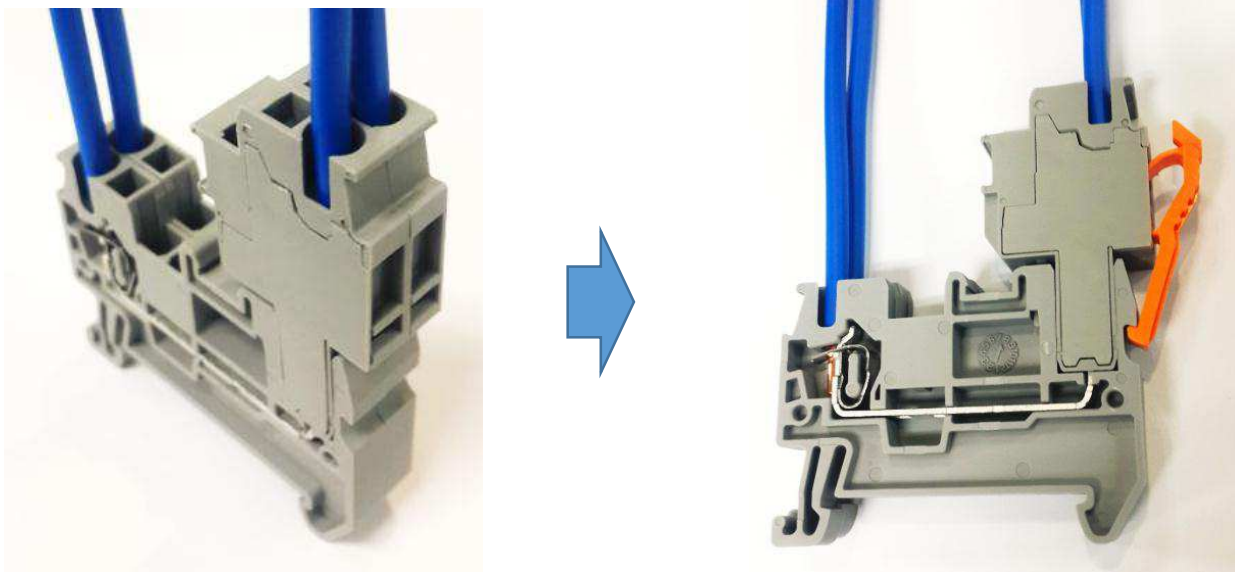

Figure 30 Fixing Spring Assembly

When need to remove the product DTS2.5 PG with Fixing spring, it should follow figure 31:

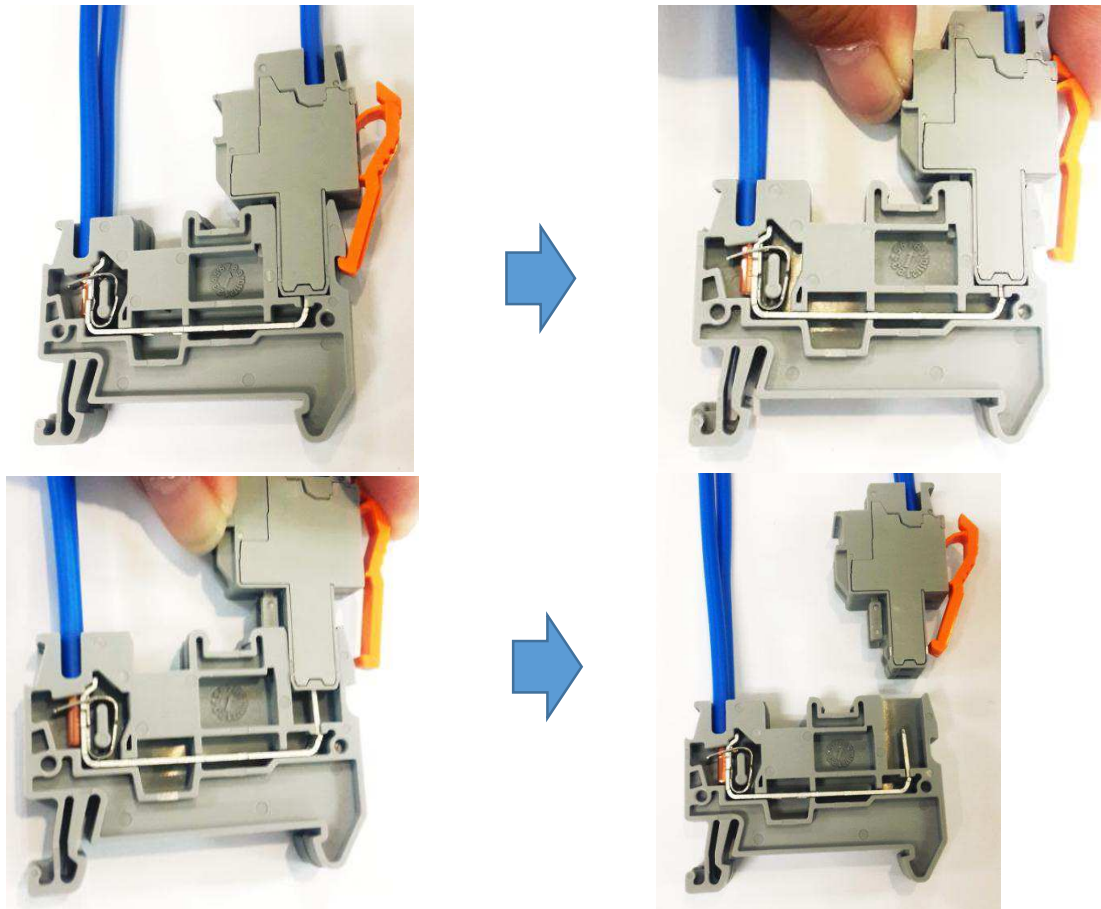

Figure 31 DTS2.5 PG removing

Din Rail Type  
**Spring Clamp Terminal Block**

When the conductors connected to DTS2.5 PG, if needed, cable tie (figure 32) can be used to tie the wire to the component-Wire locking spring, detail see figure 33

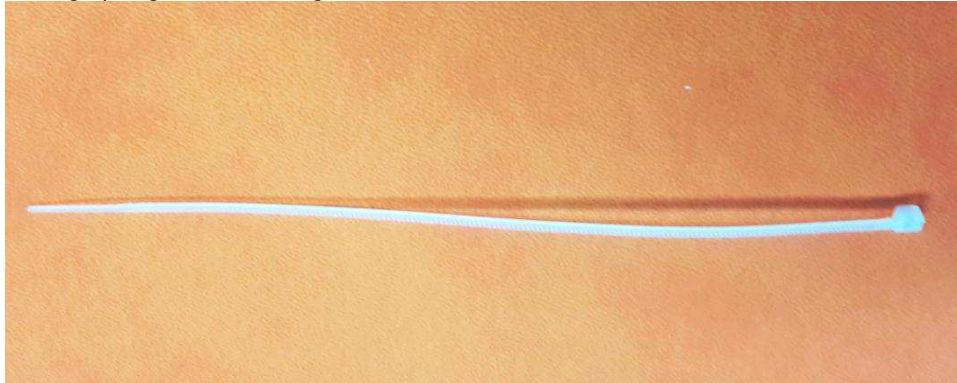

Figure 32 Cable tie

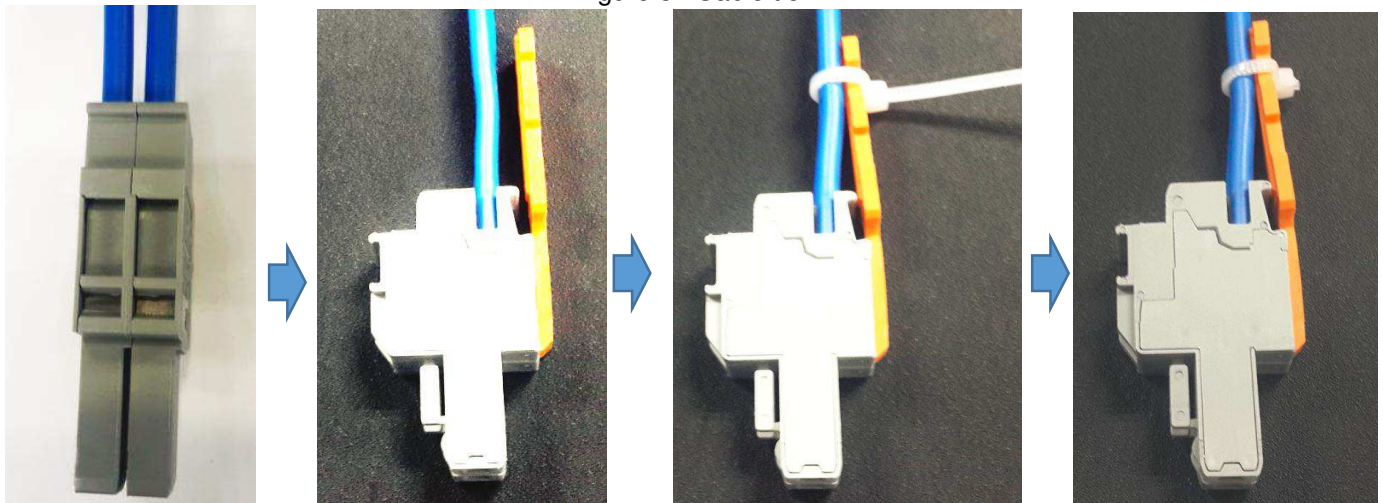

Figure 33 Wire locking spring Fixing Process



Consideration must be given to toxicity and other safety requirements recommended by the solvent manufacturer. Refer to the manufacturer's Material Safety Data Sheet (MSDS) for characteristics and handling of cleaners. Trichloroethylene and Methylene Chloride can be used with no harmful affecting to the connectors; however TE does not recommend them because of the harmful occupational and environmental effects. Both are carcinogenic (cancer-causing) and Trichloroethylene is harmful to the earth's ozone layer.