



NOTE

All numerical values are in metric units [with U.S. customary units in brackets]. Dimensions are in millimeters. Unless otherwise specified, dimensions have a tolerance of ± 0.13 and angles have a tolerance of $\pm 2^\circ$. Figures and illustrations are for identification only and are not drawn to scale.

1. INTRODUCTION

This specification covers the requirements for application of Z-PACK HM-Zd and HM-Zd Plus 2-, 3-, and 4-pair connector systems. The connector systems use a modular concept and interconnects two printed circuit (pc) boards or cable-to-pc boards. The connectors are available in vertical and right-angle press-fit pin headers and vertical (4-pair only) and right-angle press-fit receptacles. Each module has a width of 24.99 mm. The three available versions are: 2-signal contact pairs per column (20 pairs per module), 3-signal contact pairs per column (30 pairs per module), and 4-signal contact pairs per column (40 pairs per module).

The HM-Zd connectors have the same footprint to simplify pc board layout. The HM-Zd Plus connectors have a revised footprint for increased signal integrity performance. HM-Zd and HM-Zd Plus connectors are intermatable.

The connectors are designed to be seated onto the pc board via eye-of-needle compliant pin contacts. Each connector has polarization/alignment slots and lugs with a guide-in feature that helps position the contacts prior to engagement of the circuits. Universal, universal keyed, and Advanced Telecommunications Computing Architecture (AdvancedTCA) guide pins and modules (available separately) can be used with these connectors to provide error-free mating and prevent damage to the connector and contacts during mating. The receptacles and pin headers are designed to mate together.

When corresponding with TE Connectivity Personnel, use the terminology provided in this specification to facilitate your inquiries for information. Basic terms and features of this product are provided in Figure 1.

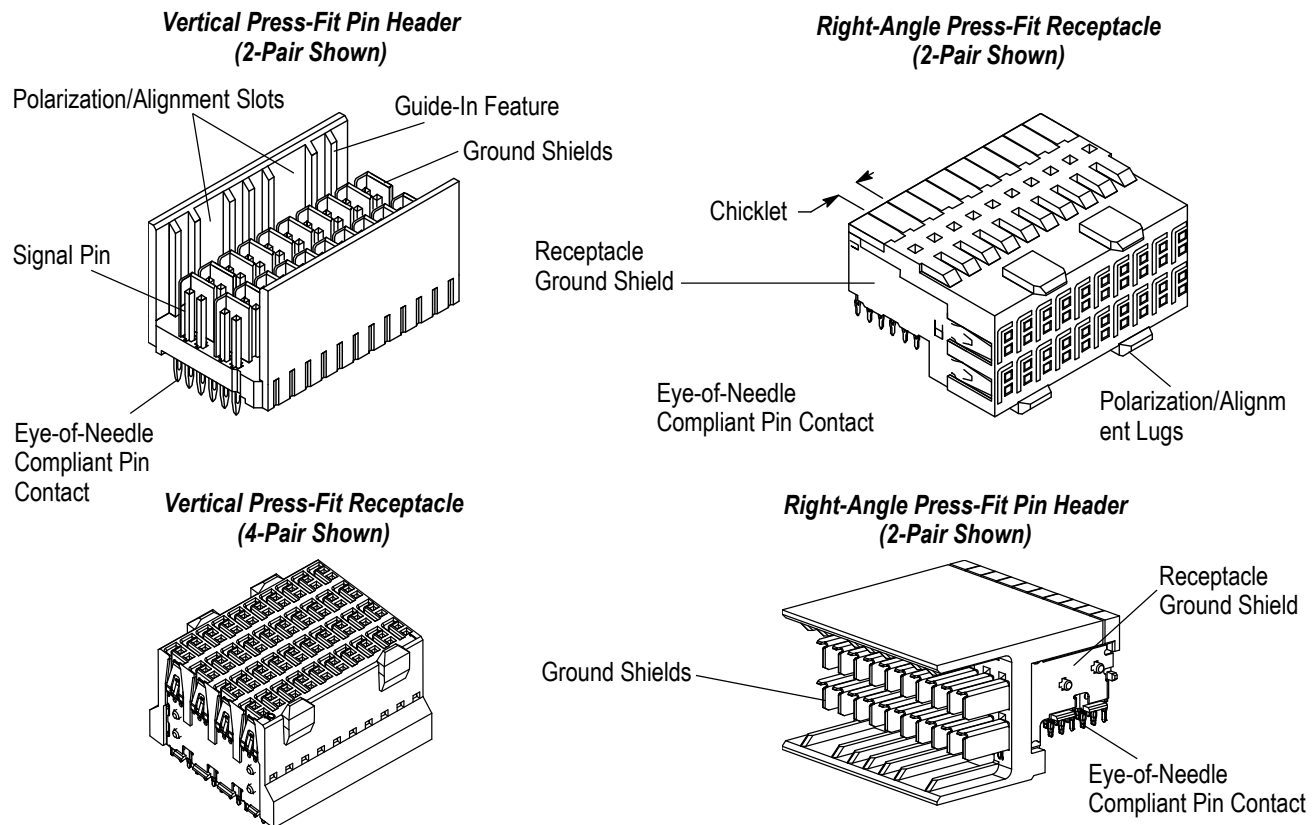

Figure 1 (cont'd)

AdvancedTCA is a trademark.

Universal Guide Pin and Guide Module

Universal Keyed Guide Pin and Guide Module

AdvancedTCA Guide Pins and Guide Module

Figure 1 (end)

2. REFERENCE MATERIAL

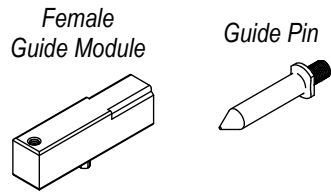
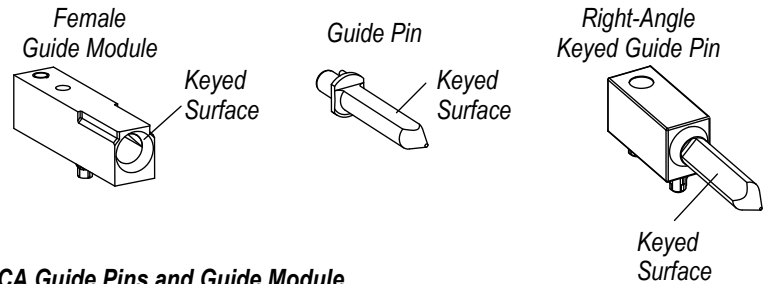
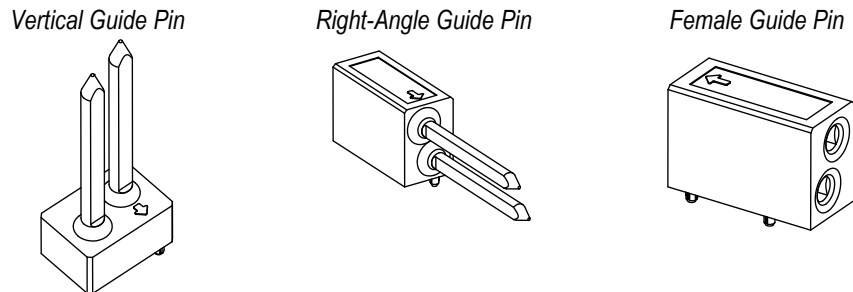
2.1. Revision Summary

- ◆ Updated document to corporate requirements
- ◆ Added pc board layout to Figure 3
- ◆ Added new information to tables in Figures 4, 9, and 11

2.2. Customer Assistance

Reference Product Base Part Numbers 1469025 (2-pair HM-Zd pin header), 1469028 (2-pair HM-Zd receptacle), 2065769 (2-pair HM-Zd Plus receptacle), and 2170328 (2-pair HM-Zd Plus pin header), and Product Codes F269 and F270 are representative of these connectors. Use of these numbers will identify the product line and help you to obtain product and tooling information when visiting www.te.com or calling the number at the bottom of page 1.

2.3. Drawings

Customer drawings for product part numbers are available from www.te.com. Information contained in the customer drawing takes priority.

2.4. Specifications

Product Specification [108-2055](#) and Qualification Test Report [501-568](#) provides product performance and test information for HM Zd connectors.

Product Specification [108-2055-1](#) provides product performance and test information for HM Zd Plus connectors.

Application Specification [114-1103](#) provides product description and application requirements for universal power modules (UPM), vertical receptacles, and right-angle pin headers used with HM Zd connectors.

2.5. Instructional Material

Instruction sheets (408-series) provide product assembly instructions or tooling setup and operation procedures. Instructional material available that pertains to this product are:

- 408-8500 Seating Tools 91347-[], 91350-[], and 91376-1 for HM-Zd Receptacle Connectors
- 408-8501 Seating Tools 91348-1, 91349-1, and 91375-1 for HM-Zd Header Connectors
- 408-8644 HM-Zd Receptacle Housing Removal Tool 1583224-1
- 408-8645 HM-Zd Header Removal Tools 1583220-1, 1583234-1, and 1673951-1
- 408-8646 HM-Zd Pin (Post) Extraction Tool 1583237-1
- 408-8647 HM-Zd Chicklet Removal Tools 1583248-1, 1583249-1, and 1673952-1
- 408-8648 HM-Zd Pin (Post) Insertion Tool 1583255-1
- 408-8785 Seating Tools 91372-1 and 91373-1 for HM-Zd Header Connectors
- 408-8810 Seating Tools 91377-1 and 91378-1 for Z-PACK HM-Zd Right-Angle Header Connectors

3. REQUIREMENTS

3.1. Storage

The product should remain in the shipping containers until ready for use to prevent deformation to components. The product should be used on a first in, first out basis to avoid storage contamination that could adversely affect performance.

3.2. Material

The housings and chicklets are molded of high-temperature rated (UL 94V-0) polyesters.

The signal pin contacts are phosphor bronze and plated at the contact interface with gold. The signal receptacle contacts are copper alloy and plated at the contact interface with gold. All contacts have a nickel underplate and tin or tin-lead plated press-fit leads. Ground contacts are phosphor bronze and plated at the contact interface with gold. All contacts have a nickel underplate and tin or tin-lead plated press-fit leads.

Universal guide modules and universal keyed guide pins are made of zinc alloy. Un-keyed guide pins are made of stainless steel. AdvancedTCA guide hardware is made of a zinc alloy casting with a nickel finish.

3.3. Selection Criteria

A. Size

Length each pin is given in Figure 2.

B. Guide Modules and Pins

The guides modules and pins are recommended for multi-connector, large and heavy daughter card applications and conditions where misalignment tolerances (given in Paragraph 3.7,A) cannot be met.

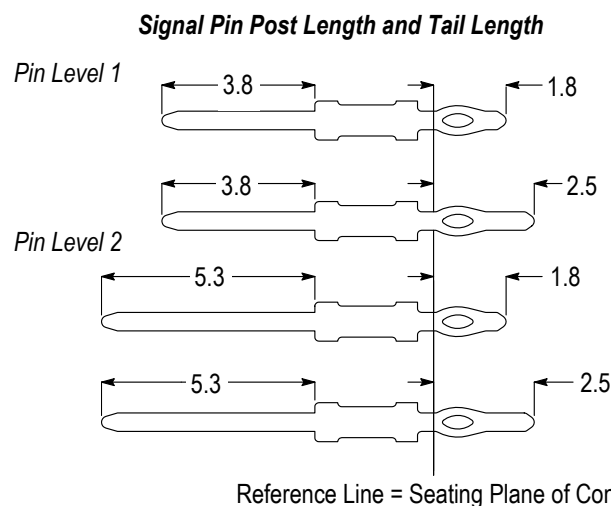

NOTE: Contact area lubricated with Bellcore-approved lubricant. Technical Reference: GR-1217-CORE, Issue 1, November 1995.

Figure 2

3.4. PC Board Requirements

A. Material and Thickness

Right-angle receptacles and pin headers require a daughter card having a minimum thickness of 1.40 mm. The maximum allowable thickness is 3.5 mm. A special pin header is required for a daughter card thicker than 3.5 mm (contact PRODUCT INFORMATION at the number at the bottom of page 1 for recommendation). For suitability of other daughter card thicknesses, contact PRODUCT INFORMATION at the number at the bottom of page 1.

Vertical receptacles and pin headers require a minimum backplane thickness of 1.40 mm to allow for positive retention of the compliant pin contacts. Midplane applications require a minimum backplane thickness of 3.8 mm. Thicker backplanes will not affect the retention of the compliant pin contact.

i NOTE
For circuit routing concerns, contact PRODUCT INFORMATION at the number at the bottom of page 1.

B. Layout

The pc board hole pattern for the placement of these connectors is provided in Figure 3. Datums and basic dimensions are established by the customer.

Recommended PC Board Layouts

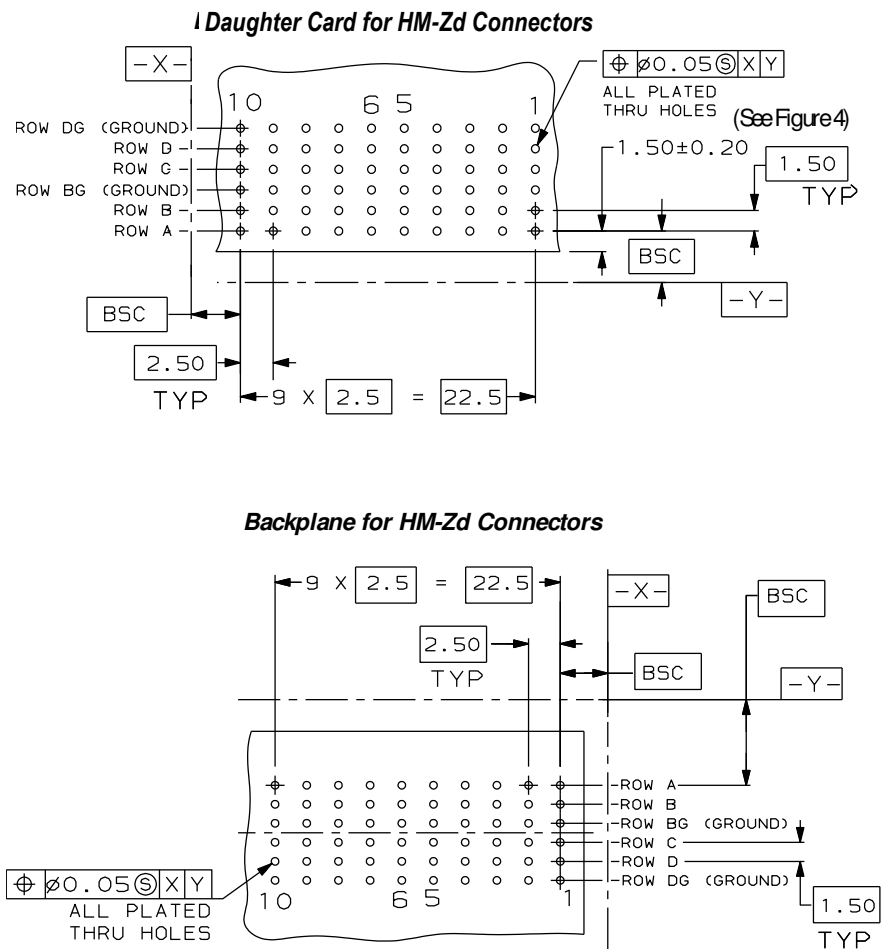
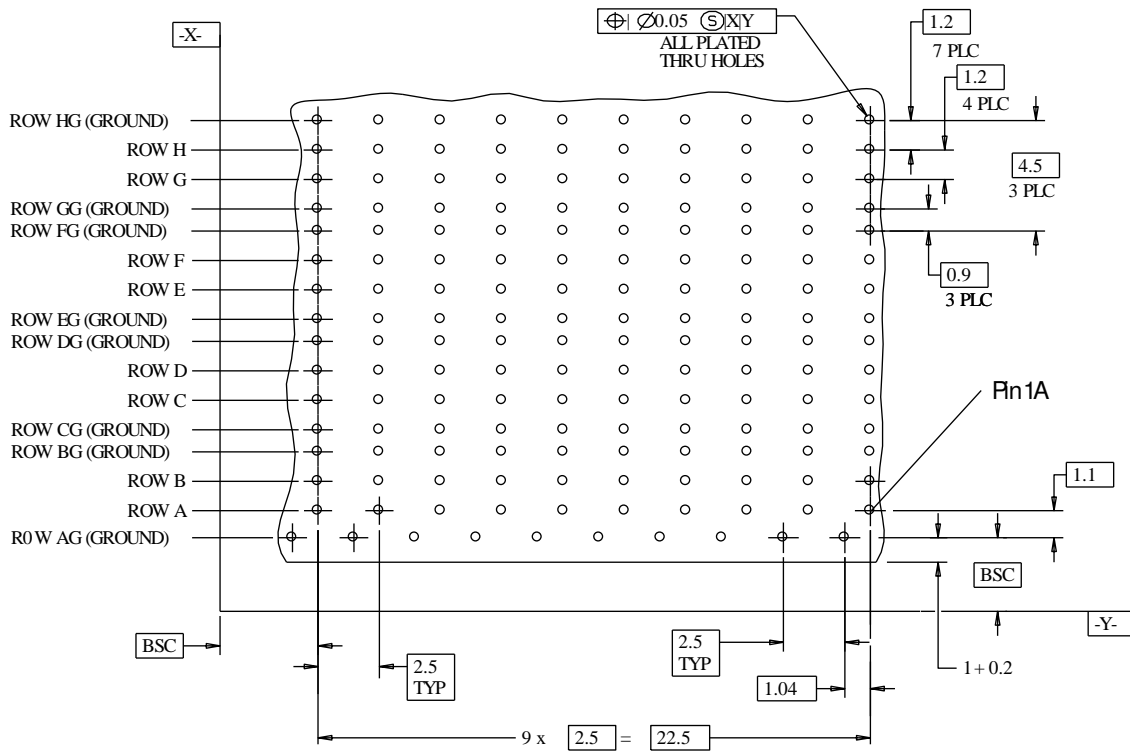
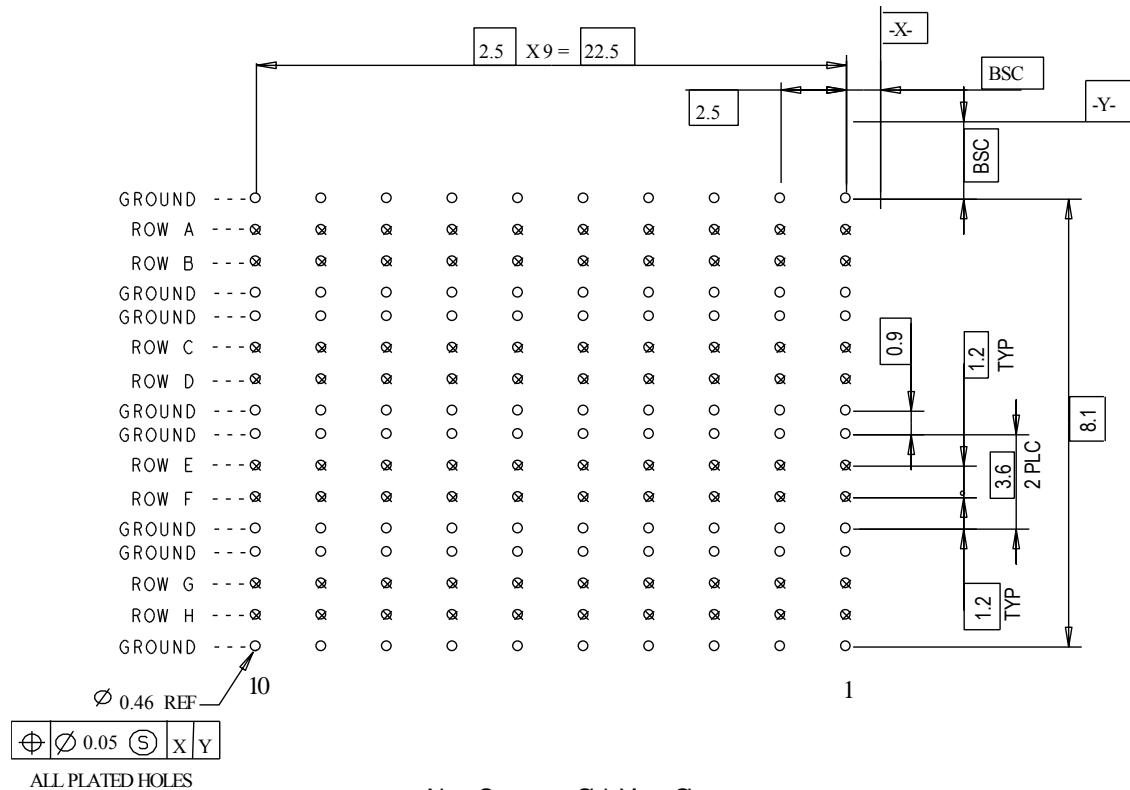

Figure 3 (cont'd)

Daughter Card for HM-Zd Plus Connectors and HM-eZd Plus Connectors



Backplane for HM-Zd Plus Connectors



Note: Component Side Views Shown

Figure 3 (cont'd)

Backplane for HM-eZd Plus Connectors

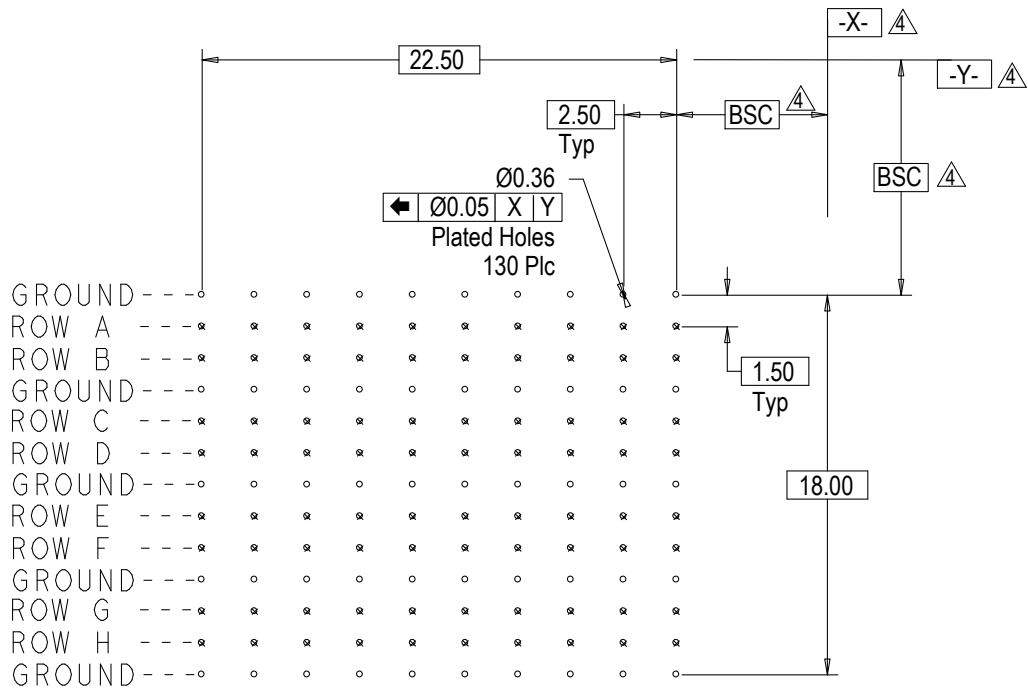
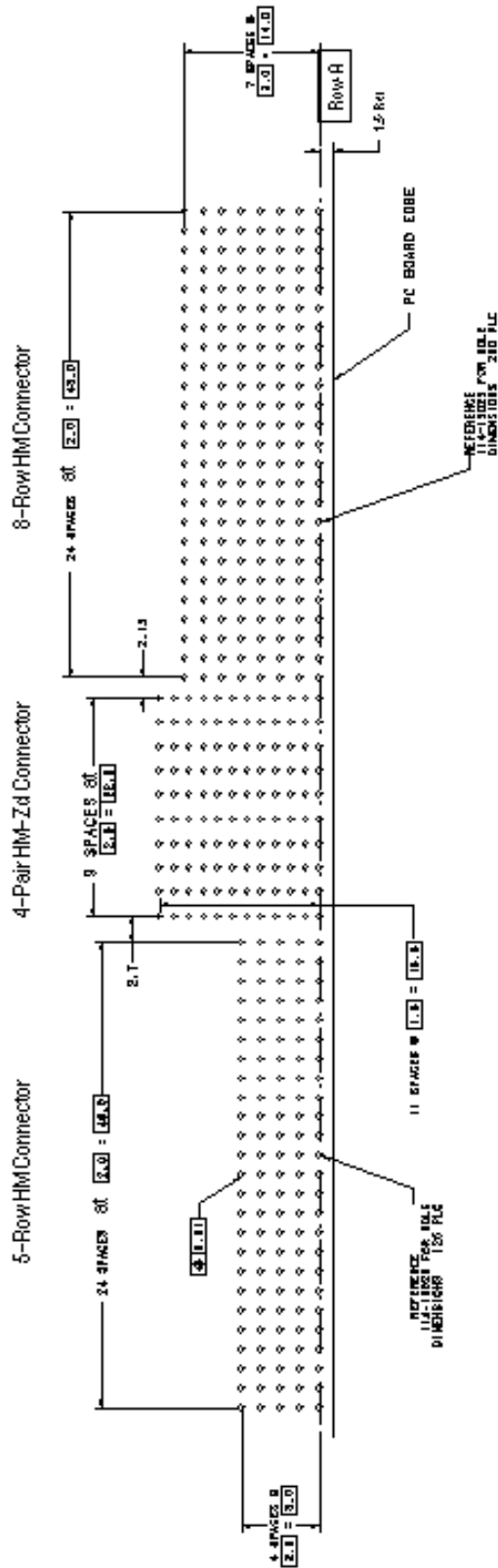

Figure 3 (cont'd)

Daughter Card - for
 HM-Zd 4-Pair Connector and 2-mm HM Connector (Ref)



Backplane - for
 HM-Zd 4-Pair Connector and 2-mm HM Connector (Ref)

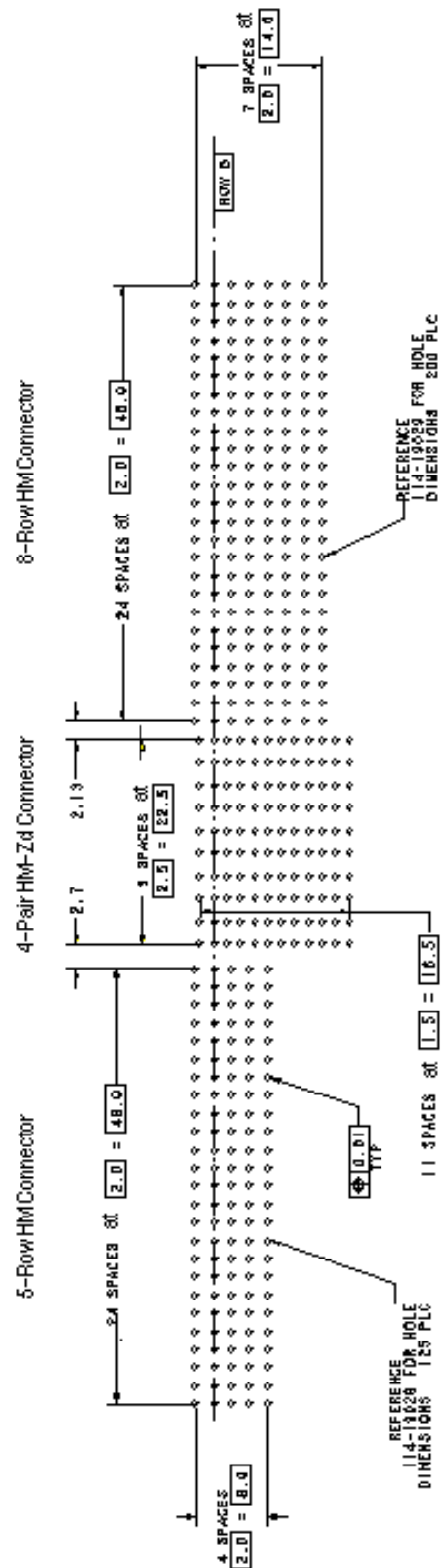
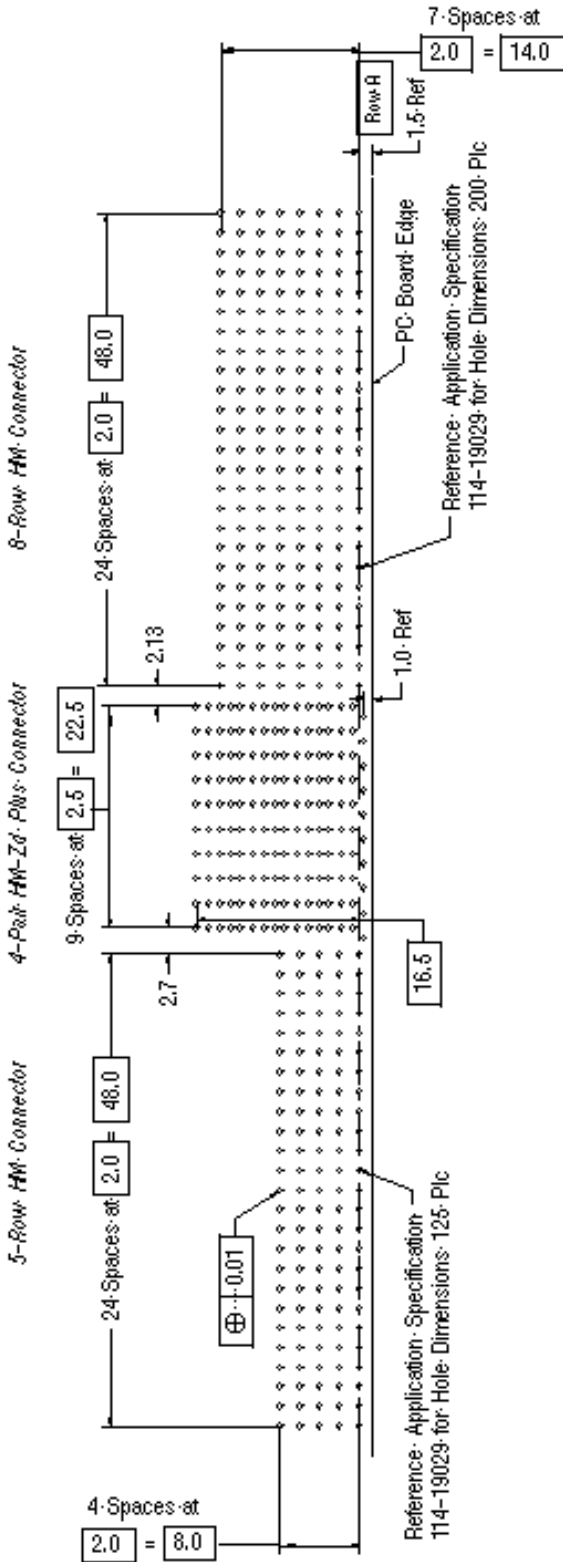

Figure 3 (cont'd)

Daughter Card for
Zd-Plus-4-Pair Connector and 2-mm HM Connector (Ref)



Backplane for
HM-Zd-Plus-4-Pair Connector and 2-mm HM Connector (Ref)

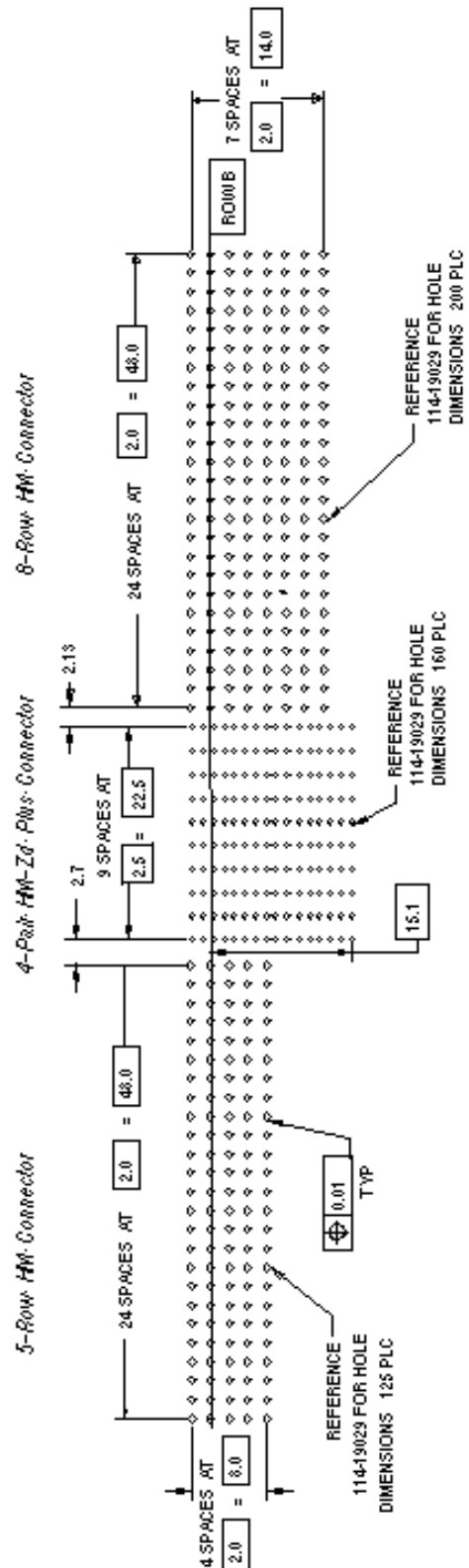

Figure 3 (cont'd)

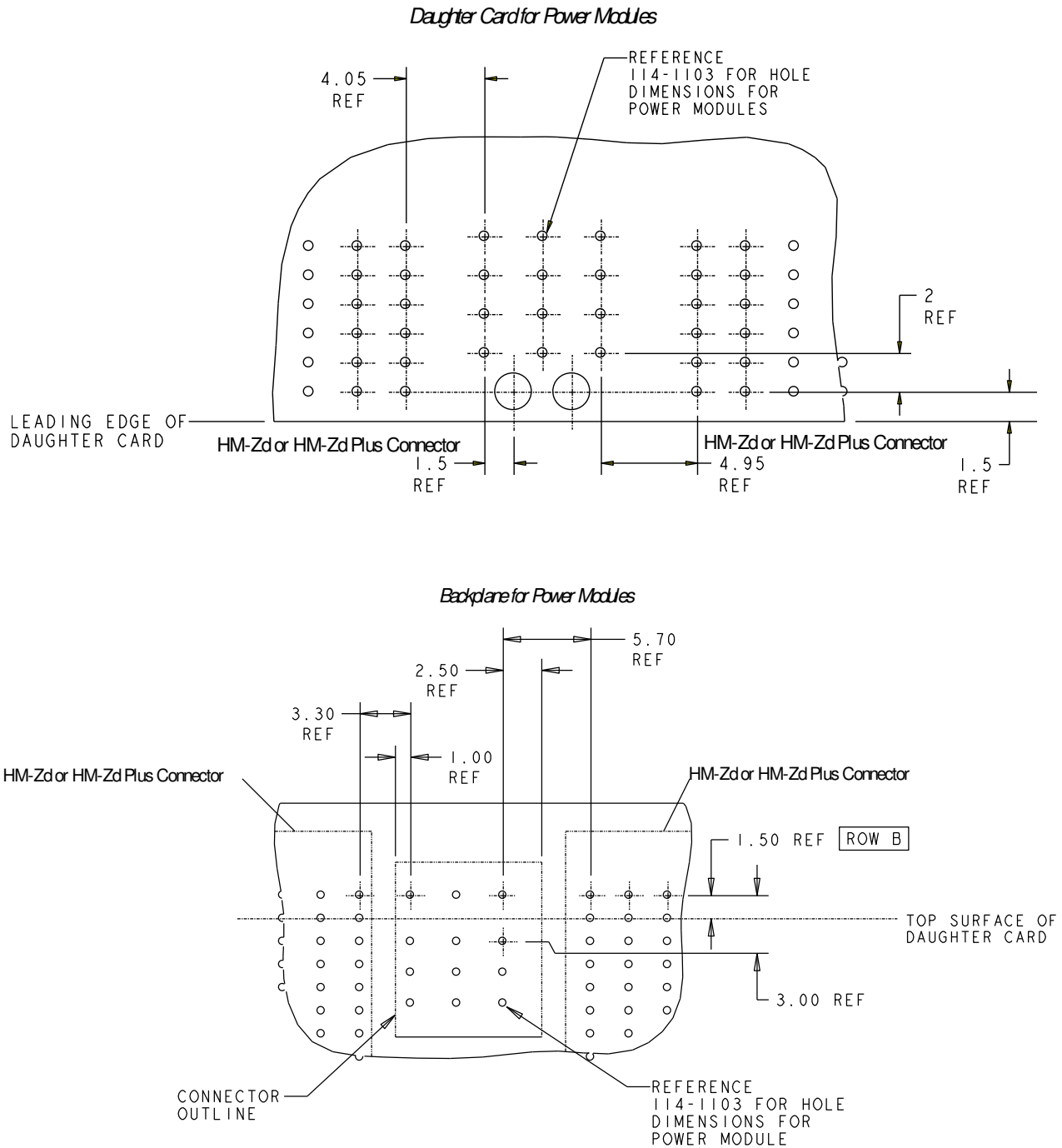

Figure 3 (end)

C. Hole Configuration

The holes in the pc board for all contacts must be drilled and plated through to the dimensions shown in Figure 4, Detail A.

For pc boards that are back-drilled-plated through hole (PTH) counter-bored-for signal integrity performance improvement, the depth of the plated hole must be no more than the dimensions given in Figure 4, Detail B.

Detail A
HM-Zd, HM-Zd Plus, HM-eZd Plus Connectors

1.40 Min Thick Daughter Card or Backplane
 3.8 Min Thick Backplane (Required for Midplane Applications)
 3.5 Max Thick Daughter Card (Special Pin Header Required for Daughter Card Thicker Than 3.5, Contact TE Engineering for Specific Information)

Detail B
HM-Zd, HM-Zd Plus, HM-eZd Plus Connectors Back-Drilled (PTH Counterboring)

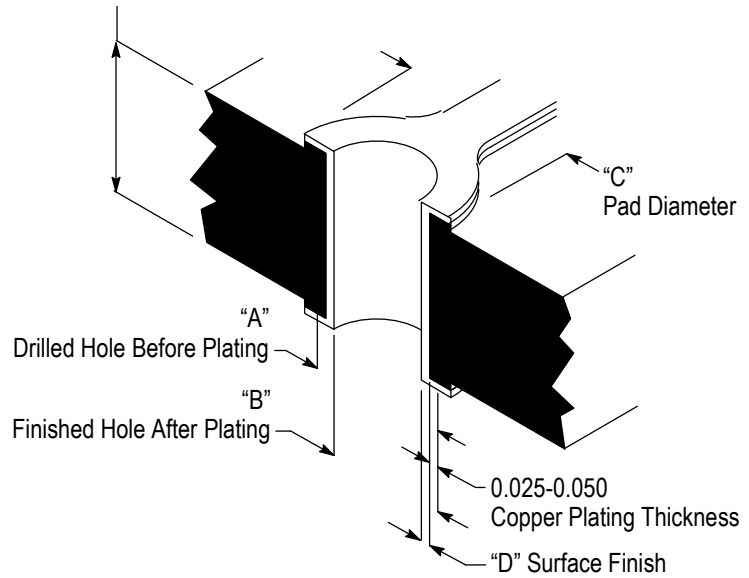
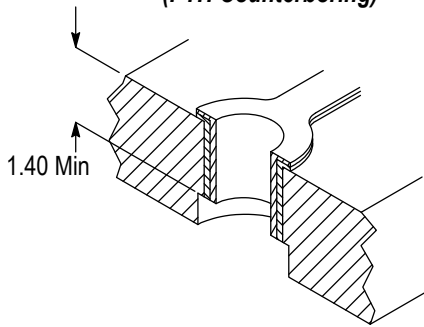

CONNECTOR	DIMENSION		
	A	B (Nominal)	C
HM-Zd	0.675-0.725	0.61●	1.00
HM-Zd Plus and HM-eZd Plus Receptacle	0.53-0.57	0.46●	0.92 (Signal) 0.80 (Ground)
HM-eZd Plus Header	0.43-0.47	0.36	0.70

SURFACE FINISH	DIMENSION D THICKNESS	
	HM-Zd Connector	HM-Zd Plus Connector
Hot Air Solder Leveling (HASL) Tin-Lead (Sn Pb)	0.004-0.010	0.0037-0.0123
Immersion Tin (Sn)	0.0005-0.004	
Organic Solderability Preservative (OSP)	0.0002-0.0005	
Immersion Gold (Au) Over Nickel (Ni) (ENIG)	0.0001-0.0005 Au 0.00127-0.0076 Ni	
Immersion Silver (Ag)	0.0001-0.0005	
Gold (Au) Over Nickel	0.0001-0.0005 Au 0.00127-0.0076 Ni	
Immersion tin (Sn)	0.0005-0.004	

- Tolerance or acceptable range of finished hole diameter is the sum of the plated through hole component tolerances. All component tolerances must be achieved.
- Min Finished Diameter = A (Min) - 2 x Copper Thickness (Max) - 2 x D (Max)
- Max Finished Diameter = A (Max) - 2 x Copper Thickness (Min) - 2 x D (Min)

Figure 4

D. Placement

Location of the connector placement on the pc board in relationship to the keying guide modules and pins shall be as shown in Figure 5.

Connectors can be mounted end-to-end within specified spacing given in Figure 6.

When using these connectors with similar Z-PACK connectors or components, it is recommended to use the spacing given in Figure 3.



NOTE

Pattern of leads is shifted by 0.45 mm with respect to the connector housing. Column-to-column spacing between butted connectors is still 2.5 mm.

**Recommended Daughter Card PC Board Spacing Layout
Z-Pack HM-Zd and HM-Zd Plus Guide Modules and Z-Pack 2 mm HM Guide Modules (Ref)**

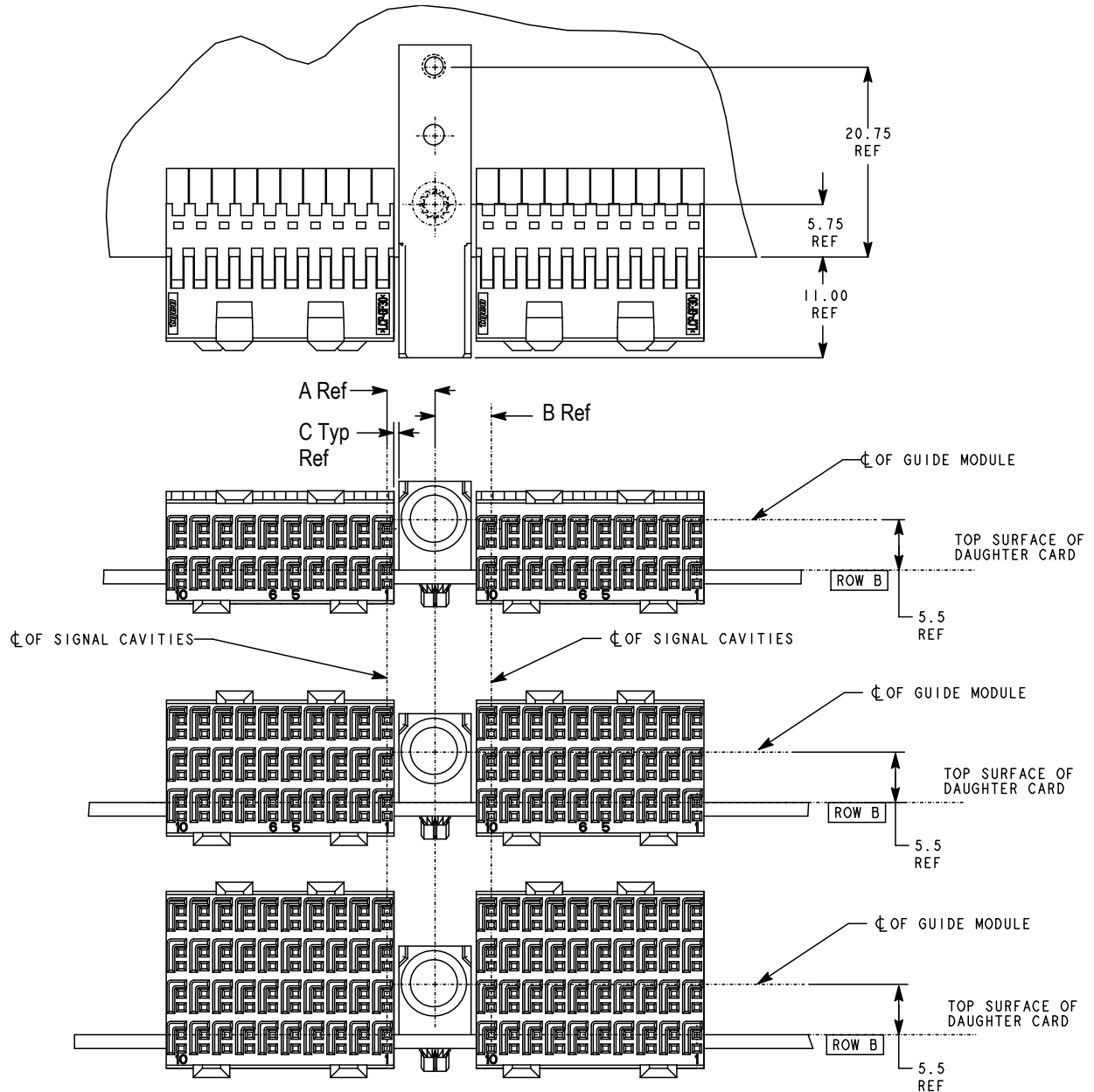

GUIDE MODULE	DIMENSION		
	A	B	C
Universal	5.25	6.15	0.56
Keyed	5.52	6.42	0.83

Figure 5 (cont'd)

**Recommended Backplane PC Board Spacing Layout
Z-Pack HM-Zd and Z-Pack 2 mm HM Guide Modules**

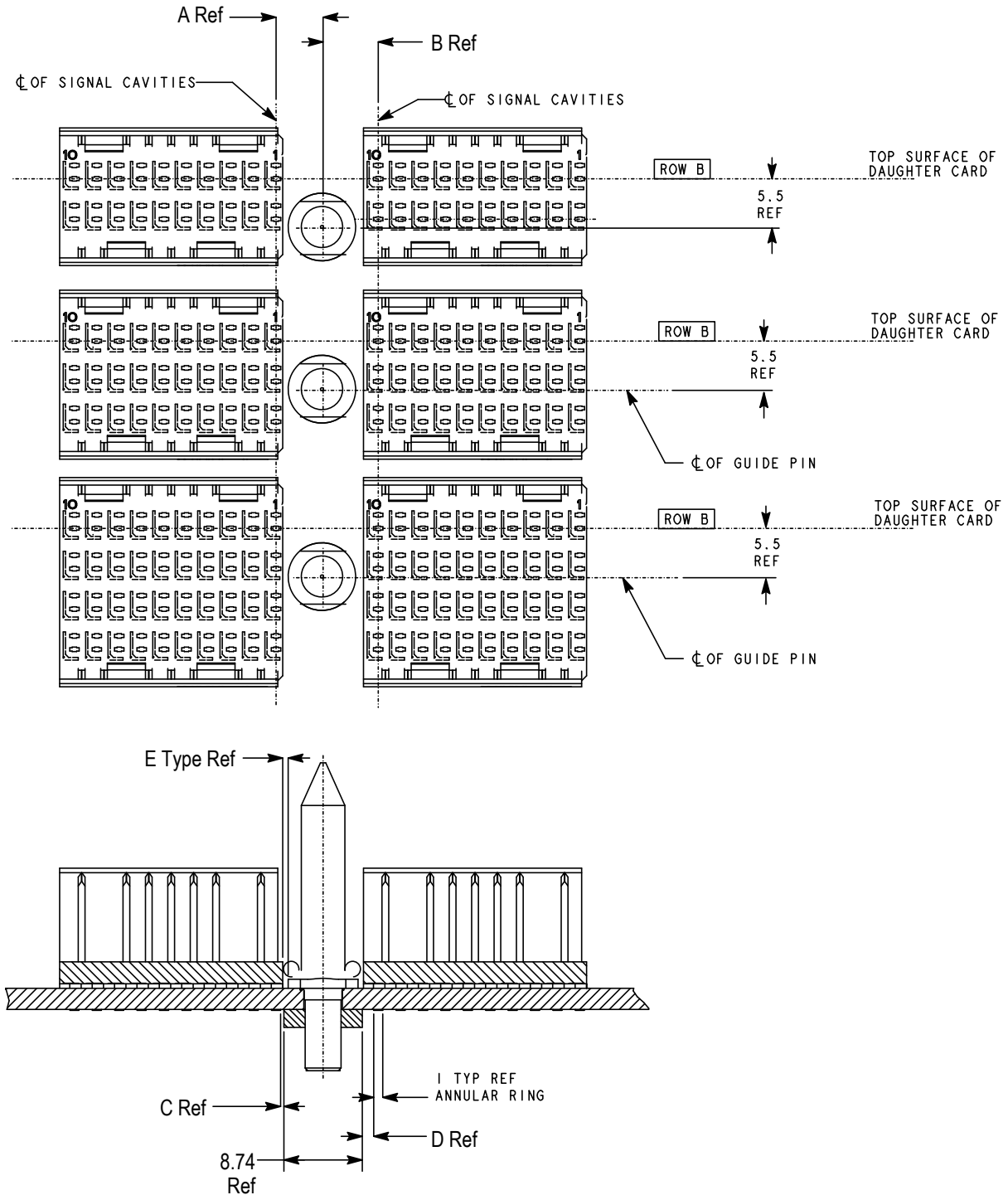

GUIDE PIN	DIMENSION				
	A	B	C	D	E
Universal	5.25	6.15	0.40	1.30	0.60
Keyed	5.52	6.42	0.65	1.55	0.42

Figure 5 (end)

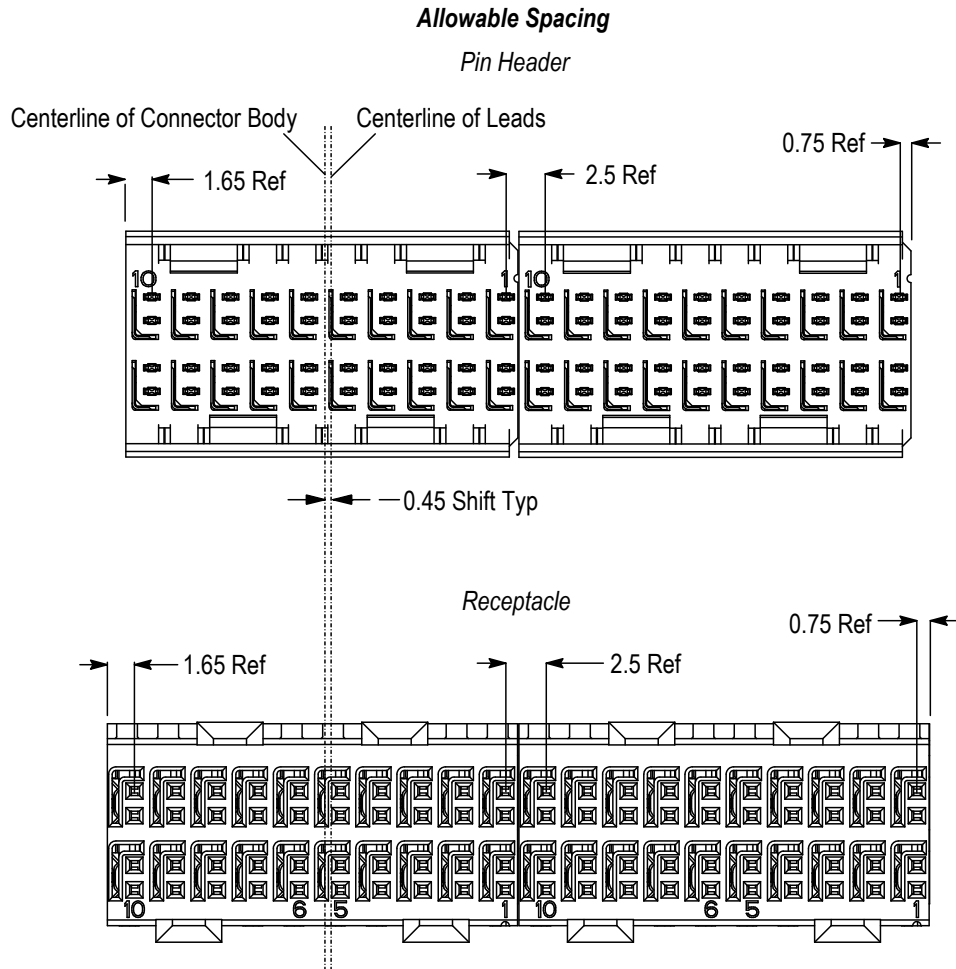

NOTE: 2-pair connector shown; 3- and 4-pair connectors are the same for dimensioning purposes.

Figure 6

3.5. Connector Seating

A. Initial Positioning

These connectors are typically manually pre-applied to a pc board. Connectors should be gripped by the housing and/or chicklets only and not by the contacts. When placing a connector onto a pc board, all contact should be aligned and inserted into the pc board simultaneously to prevent twisting or bending of the contacts.

B. Seating Connectors

A suitable machine capable of supplying a minimum controllable downward force of 70 N [15.7 lbs] per contact must be used (insertion force will vary according to pc board variations and signal pin count). Force must be applied evenly on the connectors to prevent deformation or other damage to the contacts and housings. When installing vertical pin headers, the insertion force must be simultaneously applied to the shoulders of each contact. When seating right-angle receptacles and right-angle pin headers, the insertion force must be evenly applied to the assembly (top surface of the chicklets).

Pin headers and receptacles must be seated onto the pc board to the dimensions shown in Figure 7.



CAUTION

Correct seating of connectors is essential to interconnection performance. This includes correct seating height and force applied. Over-seating of connectors will deform parts critical to the quality of the connector.

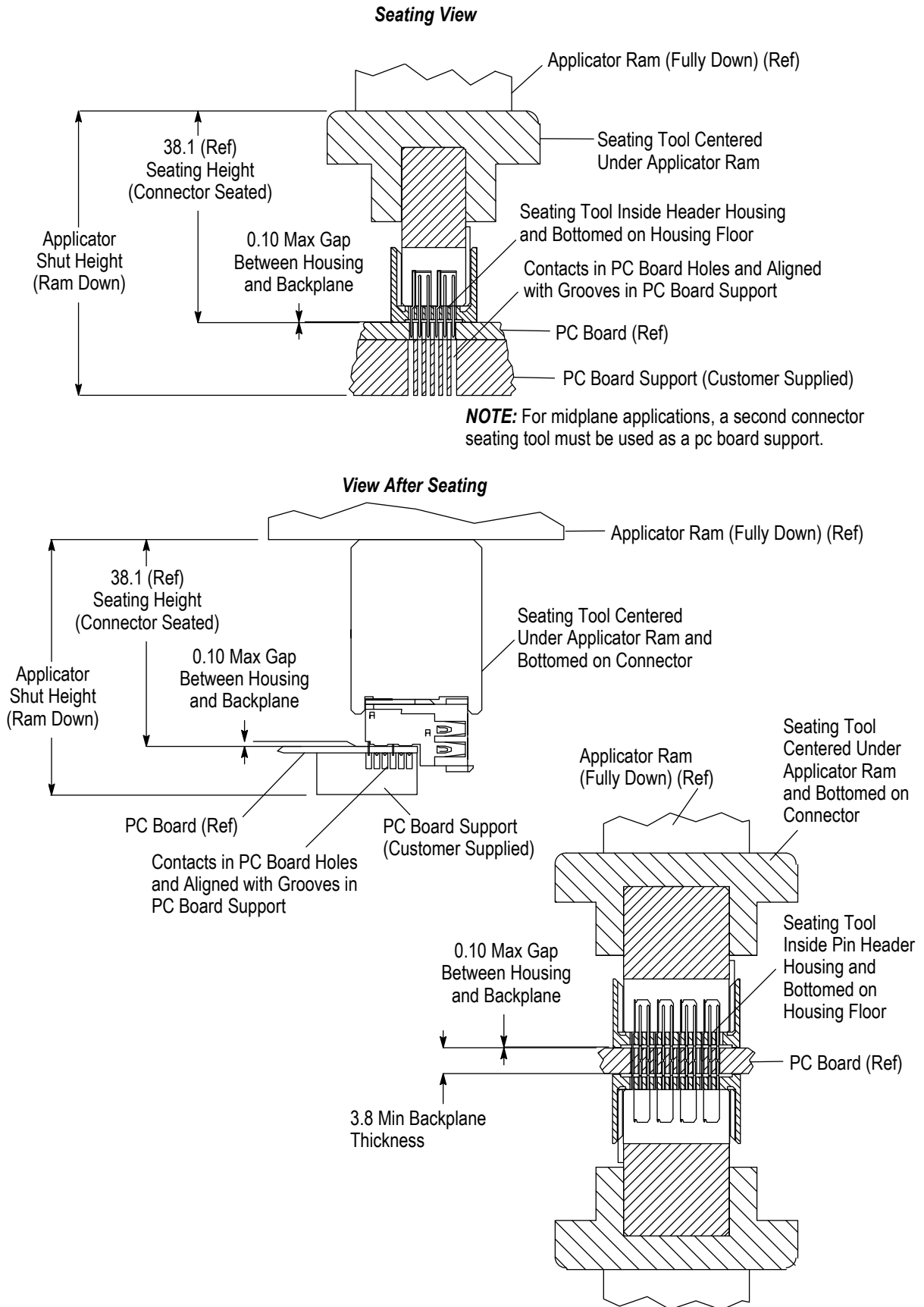

Figure 7

3.6. Solder Process Considerations

Since these connectors have press-fit compliant pin contacts, soldering is not required; however, when pc board repair or rework requires soldering after the connectors are seated on the pc board, the following applies:

A. Cleaning

After soldering, removal of fluxes, residues, and activators is necessary. Consult with the supplier of the solder and flux for recommended cleaning solvents.

Gold surfaces of contact tines must be re-lubricated with a Telcordia-approved lubricant.



CAUTION

Even when using “no clean” solder paste, it is imperative that the contact interface be kept clean of flux and residue, since it acts as an insulator.



DANGER

Consideration must be given to toxicity and other safety requirements recommended by the solvent manufacturer. Refer to the manufacturer’s material safety data sheet (MSDS) for characteristics and handling of cleaners. Trichloroethylene and methylene chloride is not recommended because of harmful occupational and environmental effects. Both are carcinogenic (cancer-causing).

B. Drying

Air drying of cleaned connectors is recommended; however, temperature for the connectors should be within -65 and 105°C [-149 and 221°F]. Degradation of the housings could result from extreme temperatures.

3.7. Mating

A. Alignment

Proper alignment is essential to ensure full engagement of mating connectors, and to ensure that contacts are not bent or otherwise damaged during mating and unmating. For tolerance limitations, see Figure 8.

NOTE: 2-pair connector shown; 3- and 4-pair connectors are the same for dimensioning purposes.

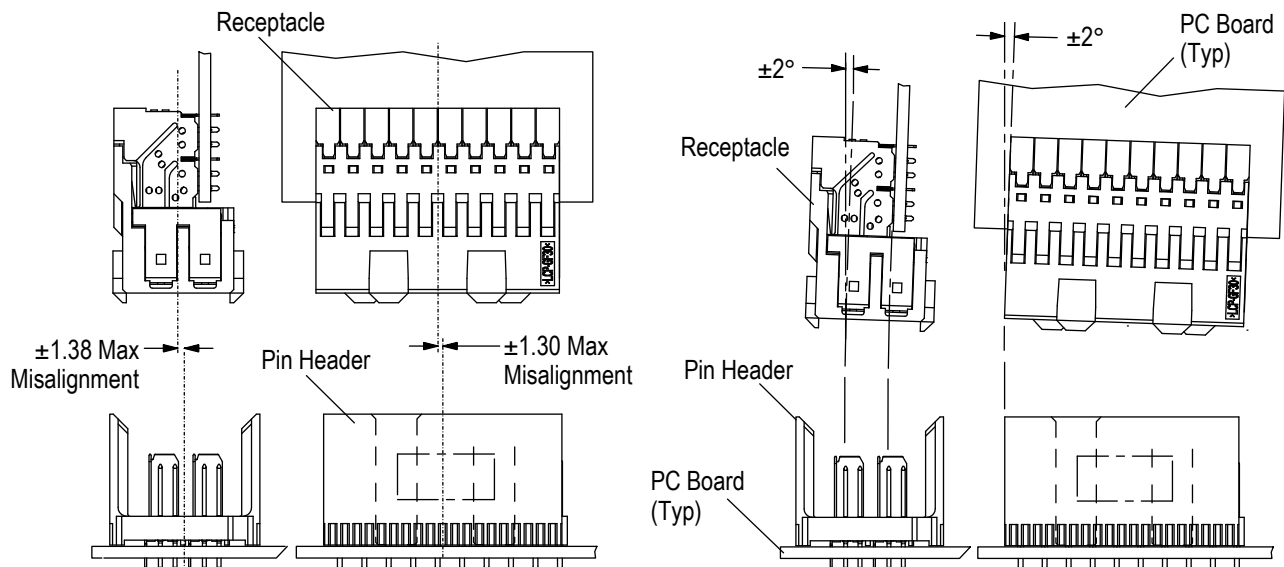

Figure 8

Telcordia is a trademark.

B. Sequencing

These connectors have three levels of sequencing during mating. The order of mating is: ground, signal pin Level 2, and signal pin Level 1. The mating sequences are the same throughout the 2-, 3-, and 4-pair connectors. The relative distances between sequencing events as a function of the distance between the top of the backplane and the centerline of Row A contact tails of the receptacle are given in Figure 9.

NOTE: 2-pair connectors shown; 3- and 4-pair connectors are the same for dimensioning purposes.

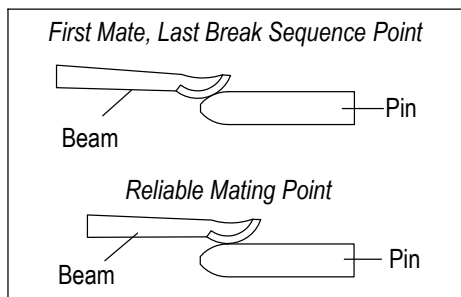
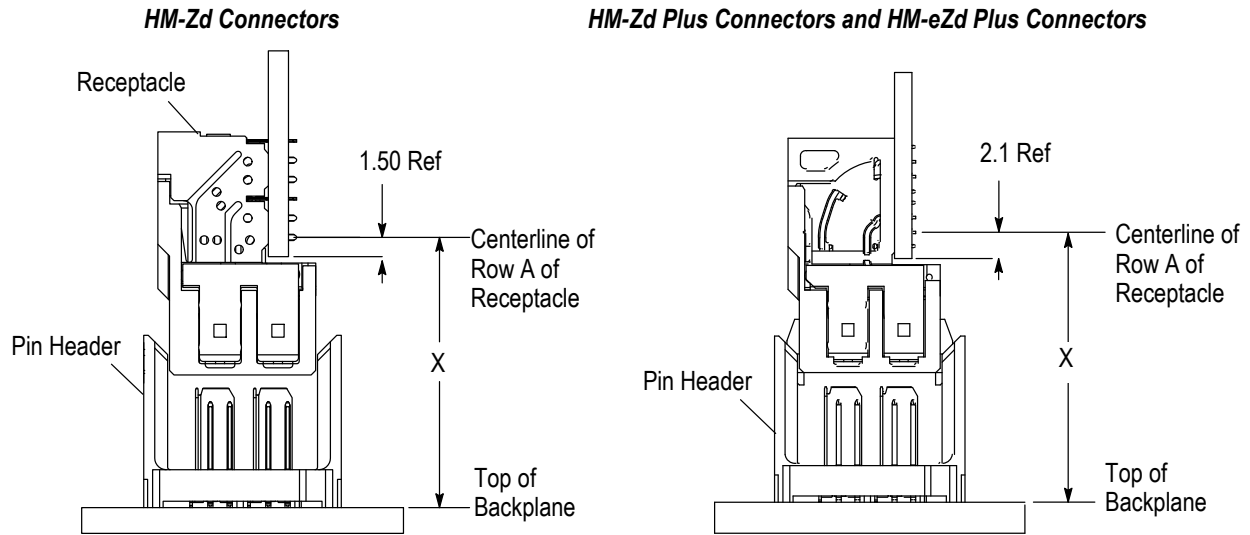

NOTE: The first mate, last break (FMLB) sequence point is the first and last instance in a mating cycle where the pin comes in contact with the beam; but has not deflected the beam.

The reliable mating point is the first and last instance in a mating cycle where the pin has completely deflected the beam, and the beam is supplying full normal force to the pin.

COMPONENT DESCRIPTION	DIMENSION X					
	HM-Zd CONNECTORS		HM-Zd PLUS CONNECTORS		HM-eZd PLUS CONNECTORS	
	FMLB SEQUENCE POINT	RELIABLE MATING POINT	FMLB SEQUENCE POINT	RELIABLE MATING POINT	FMLB SEQUENCE POINT	RELIABLE MATING POINT
Ground Blades (Receptacle Ground Shield and Pin Header Ground Shield Engage)	19.05	18.28	19.65	18.88	19.65	18.88
Level 2 Signal Pins (Receptacle Twin Beam Contact and Pin Header Signal Pin Engage)	17.35	16.91	17.95	17.51	17.19	16.75
Level 1 Signal Pins (Receptacle Twin Beam Contact and Pin Header Signal Pin Engage)	15.85	15.41	16.45	16.01	17.91	16.75
Connector Fully Mated (Both Connectors are Fully Mated) See Figure 10	14.00	14.00	14.60	14.60	14.60	14.60

NOTE: All dimensions are calculated using nominal connector conditions. Connectors are assumed to be seated flush with the pc board.

Figure 9

C. Mating Dimensions

Full mating of connectors is necessary to ensure a good connection and to obtain the maximum signal transmission performance. The fully-mated dimension from the top surface of the pc board to which the pin header is mounted and the first row of contacts in the receptacle is given in Figure 10.

NOTE: 2-pair connectors shown; 3- and 4-pair connectors are the same for dimensioning purposes.

Right-Angle and Vertical Connectors

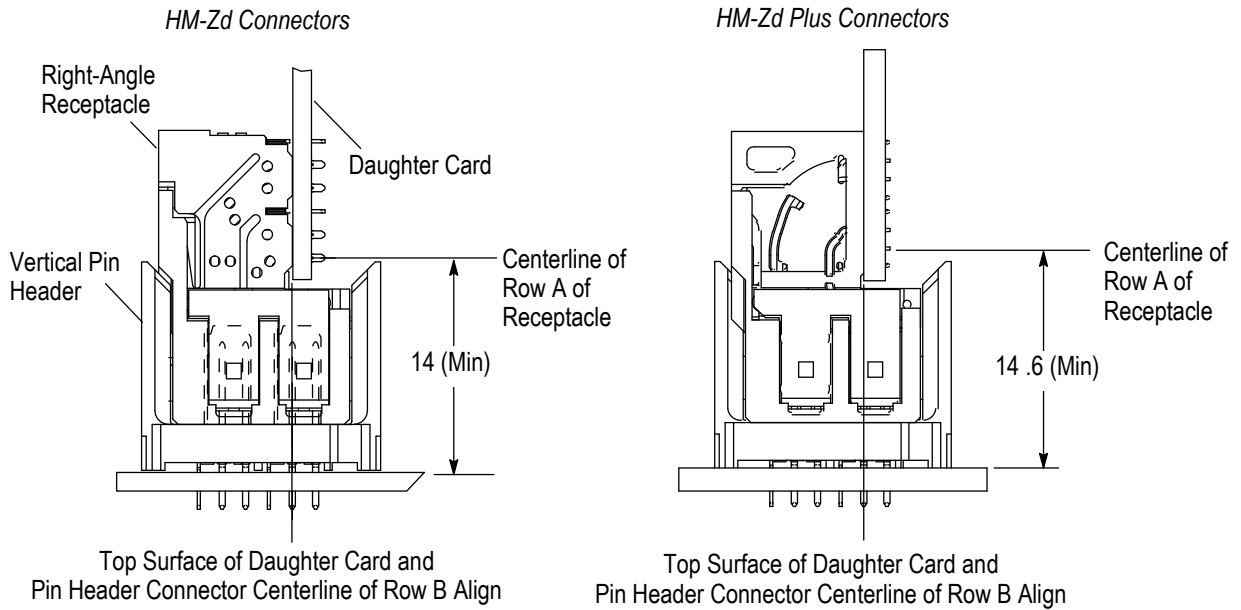

Vertical and Vertical (4-Pair) Connectors

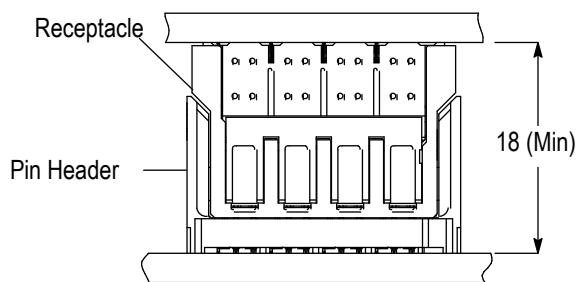

Coplanar Connectors

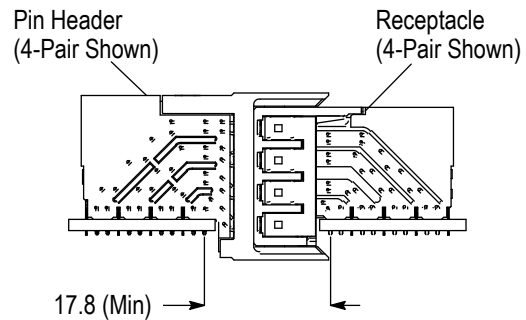

Figure 10

D. Contact Wipe Lengths

Connector contact wipe lengths are given in Figure 11.



NOTE

Wipe lengths are calculated by subtracting the reliable mating point data (given in Figure 9) from the fully mated connector condition (given in Figure 10).

COMPONENT	WIPE LENGTH (Dimension X = 14 Min or X = 14.6 Min)	HM-eZd Plus
Ground Blades	4.28	4.28
Level 2 Signal Pins	2.91	2.15
Level 1 Signal Pins	1.41	

Figure 11

3.8. Accessories

Universal and universal keyed guide pins and modules and AdvancedTCA guide pins and modules are available for production and assembly needs.

The guide pin and female guide module are designed to help connector alignment. Interaction of these two pieces of hardware provide error-free mating and prevents mating damage to the connector housings and contacts. They are also recommended for multi-connector, large and heavy daughter card applications and conditions where the misalignment tolerances shown in Figure 8 cannot be met. Insertion of the guide modules and pins into the pc boards must be applied with tooling capable of supplying a downward pressure between 222 and 667 N [50 and 150 lbs]. Refer to Figure 12 for customer-supplied seating tool dimensions.

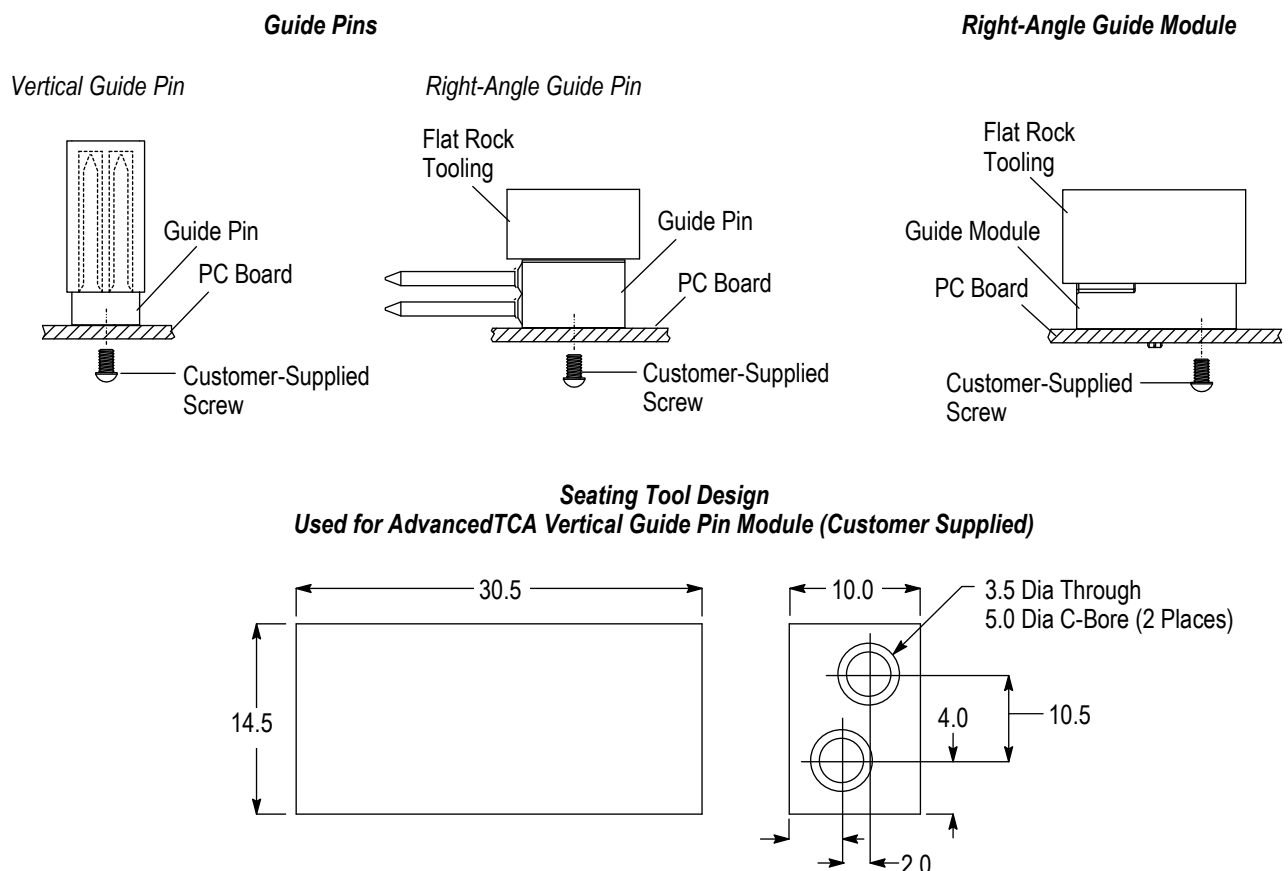

AdvancedTCA is a trademark.

Figure 12

3.9. Replacement and Repair

i **NOTE**
To ensure plated through-hole integrity, connectors should only be replaced no more than two times or a max of three insertions per pc board. Tools for removing connectors from pc boards are provided in Section 5, TOOLING.

A. Pin Header

In cases where only signal pin contacts are in need of replacement, pin header assemblies can be repaired without removal from the pc board. For ground blade repair, the entire pin header must be removed from the backplane and replaced with a new pin header.

B. Receptacle

Receptacle construction does not allow for replacement of individual contacts or shields. Damaged receptacles must be completely replaced. Receptacles can be repaired by removing and replacing only the damaged connector module.

4. QUALIFICATIONS

Z-PACK HM-Zd Connector Systems are Recognized by Underwriters Laboratories Inc. (UL) in File E28476, Vol. 54.

5. TOOLING

Tooling part numbers and instructional material packaged with the tooling are given in Figure 13.

i **NOTE**
Tooling engineers have designed machines for a variety of application requirements. For assistance in setting up prototype and production line equipment, call the PRODUCT INFORMATION number at the bottom of page 1.

5.1. PC Board Support

A pc board support must be used to prevent bowing of the pc board during the seating of a connector onto the board. It should have a flat surface with holes or a channel wide and deep enough to receive any contacts that may protrude below the pc board surface during seating of the connector.

5.2. Seating Tools

Seating tools have been designed to push on the contacts and seat the connector on the pc board. The tool will prevent contacts from backing out of the housing and prevent damage to the housing. The seating tool must be used with application tool or power unit.

5.3. Power Units

Power units are automatic or semi-automatic machines used to assist in the application of a product. These power units supply the necessary force onto a seating tool used to seat the connector onto the pc board.

i **NOTE**
For application assistance concerning proper sizing of power units, contact the Automation Group at (215) 657-6202.

5.4. Arbor Frame Assembly

Manual arbor frame assemblies are used to exert a downward force onto a seating tool used to seat the connector onto the pc board.

5.5. Extraction Tools

Extraction tools and removal tools are designed to remove individual contacts from the connector or pc board, or housings from the pc board without damaging any other components.

5.6. Insertion Tools

Insertion tools are designed for inserting individual contacts into the connector or pc board, and seating tools are designed for seating guide pins and modules or connector assemblies onto the pc board without damaging or touching other components.



Model AP3 Machine
1585280-1



Model BMEP 5T Machine
1585696-1



Model MEP 6T Machine
1585699-1

Not Shown:

Model BMEP 2K Machine 1585732-2

Model BMEP 3T Machine 1585697-1

Model MEP 12T Machine 1585698-1

Model AEP 12T Machine 1-1399600-7

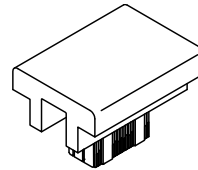
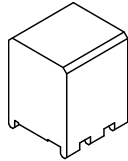

Typical Pin Header
Seating Tool
(See Table)

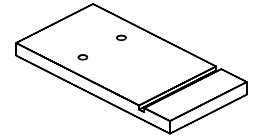

PC Board Support
(Must be Custom Made)

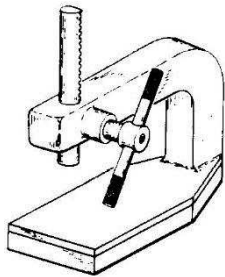

Manual Arbor Frame
Assembly
(Commercially Available)

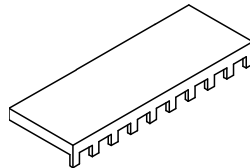

Receptacle Housing
Removal Tool 1583224-1
for Standard HM-Zd Only
(408-8644)

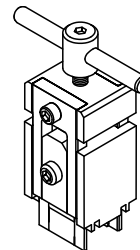

Typical Pin Header
Removal Tool
(See Table)



Typical Chicklet Removal
Tool (See Table) for
Standard HM-Zd Only

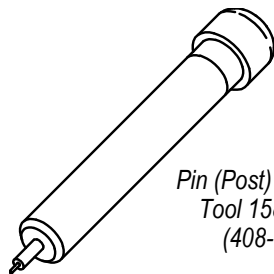

Pin (Post) Extraction
Tool 1583237-1
(408-8646)

Pin (Post) Insertion Tool
1583255-1
(408-8648)

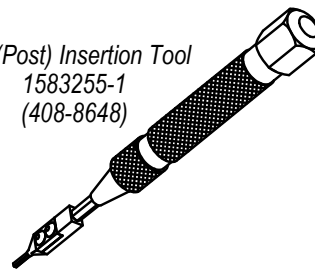

Figure 13 (cont'd)

HM-Zd CONNECTOR		BOARD-TO-BOARD TOOLING (Document)				
SIZE	TYPE	SEATING TOOL (Used in All Power Units Listed in Figure 13)	REPAIR TOOL			
			HOUSING REMOVAL	PIN EXTRACTION	PIN INSERTION	CHICKLET REMOVAL
2-Pair	Right-Angle Receptacle	91350-[] (408-8500)	1583224-[] (408-8644)	---	---	1583249-1 (408-8647)
	Right-Angle Pin Header	91377-1	1804171-1	---	---	1804175-1
	Vertical Pin Header	91348-[] (408-8501)	1583234-1 (408-8645)	1583237-1 (408-8646)	1583255-1 (408-8648)	---
3-Pair	Right-Angle Receptacle	91376-1 (408-8500)	1583224-[] (408-8644)	---	---	1673952-1
	Right-Angle Pin Header	1804179-1	1804173-1	---	---	1804176-1
	Vertical Pin Header	91375-1 (408-8501)	1725634-1 (408-8645)	1583237-1 (408-8646)	1583255-1 (408-8648)	---
4-Pair	Right-Angle Receptacle	91347-1 (408-8500)	1583224-[] (408-8644)	---	---	1583248-1 (408-8647)
	Vertical Receptacle	1804401-1	1804402-1	---	---	---
	Right-Angle Pin Header	91378-1 (408-8810)	1804174-1	---	---	1804177-1
	Vertical Pin Header	91349-[] (408-8501)	1583220-1 (408-8645)	1583237-1 (408-8646)	1583255-1 (408-8648)	---

HM-Zd CONNECTOR		CABLE-TO-BOARD TOOLING (Document)				
SIZE	TYPE	SEATING TOOL (Used in All Power Units Listed in Figure 13)	REPAIR TOOL			
			HOUSING REMOVAL	PIN EXTRACTION	PIN INSERTION	CHICKLET REMOVAL
2-Pair	Right-Angle Pin Header	1804178-1	1804172-1	---	---	1804175-1
	Vertical Pin Header	91372-1 (408-8785)	1804170-1	1583237-1 (408-8646)	1583255-1 (408-8648)	---
4-Pair	Right-Angle Pin Header	1804244-1	1804239-1	---	---	1804177-1
	Vertical Pin Header	91373-1 (408-8785)	1725635-1 (408-8645)	1583237-1 (408-8646)	1583255-1 (408-8648)	---

NOTE: All seating tools are interchangeable between HM-Zd and HM-Zd plus connectors. Housings and chicklet removal and repair tools may only be used for HM-Zd connectors.

Figure 13 (end)

6. VISUAL AID

The illustration below shows a typical application of this product. This illustration should be used by production personnel to ensure a correctly applied product. Applications which do not appear correct should be inspected using the information in the preceding pages of this specification and in the instructional material shipped with the product or tooling.

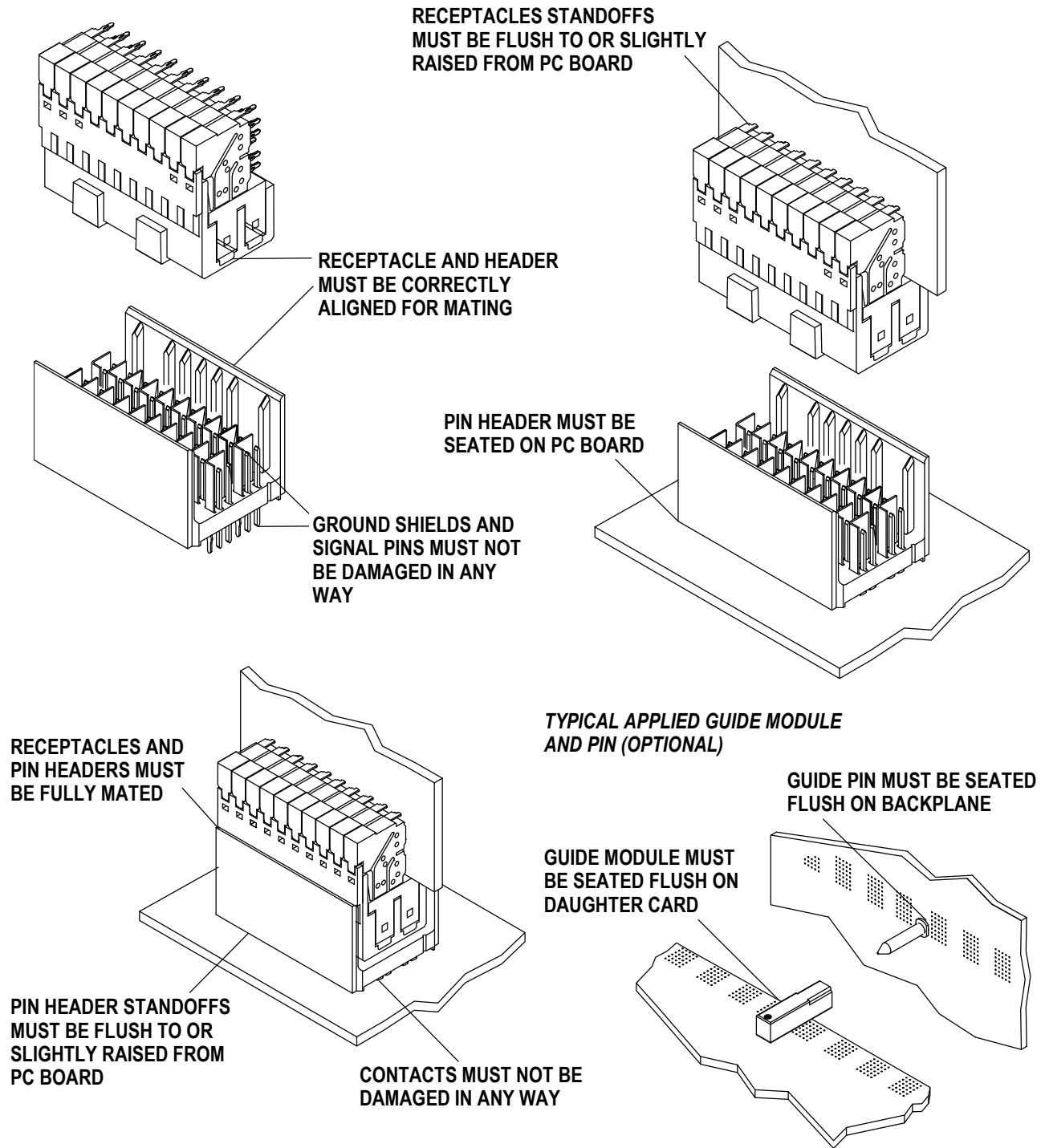

FIGURE 14. VISUAL AID