

**NOTE**



All numerical values are in metric units [with U.S. customary units in brackets]. Dimensions are in millimeters [and inches]. Unless otherwise specified, dimensions have a tolerance of  $\pm 0.13$  [ $\pm 0.005$ ] and angles have a tolerance of  $\pm 2^\circ$ . Figures and illustrations are for identification only and are not drawn to scale.

**1. INTRODUCTION**

This specification covers requirements for application of MICTOR Vertical Board-to-Board Plugs and Receptacles designed for pc boards. The connectors have an in-row contact spacing on 0.64 [.025] centerlines. There are designs to accommodate 38 through 266 contact positions. The connectors are designed for manual or robotic placement on pc boards of various thicknesses.

Plug and receptacle connectors are available in various stack heights (see Figure 1), and right-angle designs. The Vertical Plugs are identified with stack heights that describe their board-to-board distance when assembled with a standard receptacle. Receptacle Connectors are available in vertical configurations which mate with either vertical or right-angle plugs. An extended height receptacle is also available which adds additional mated heights to the vertical product family. Vertical connectors are polarized by an orientation feature that is located at the end of the housing. The date code and position one indicator are marked on the side of the housings of all connectors.

Figure 1 provides connector features and terms used throughout this specification. Use these terms when corresponding with TE Connectivity (TE) Personnel to facilitate assistance.

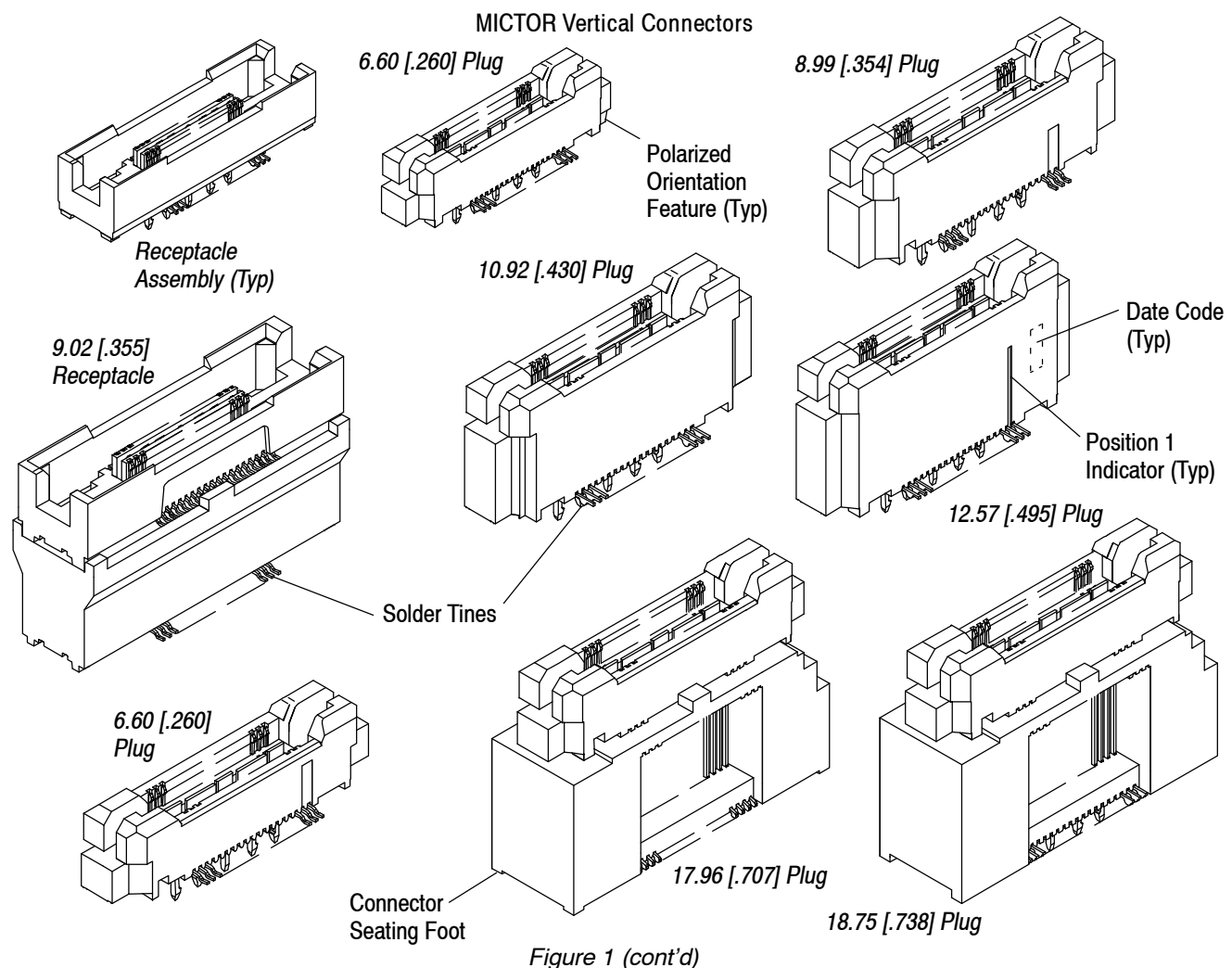

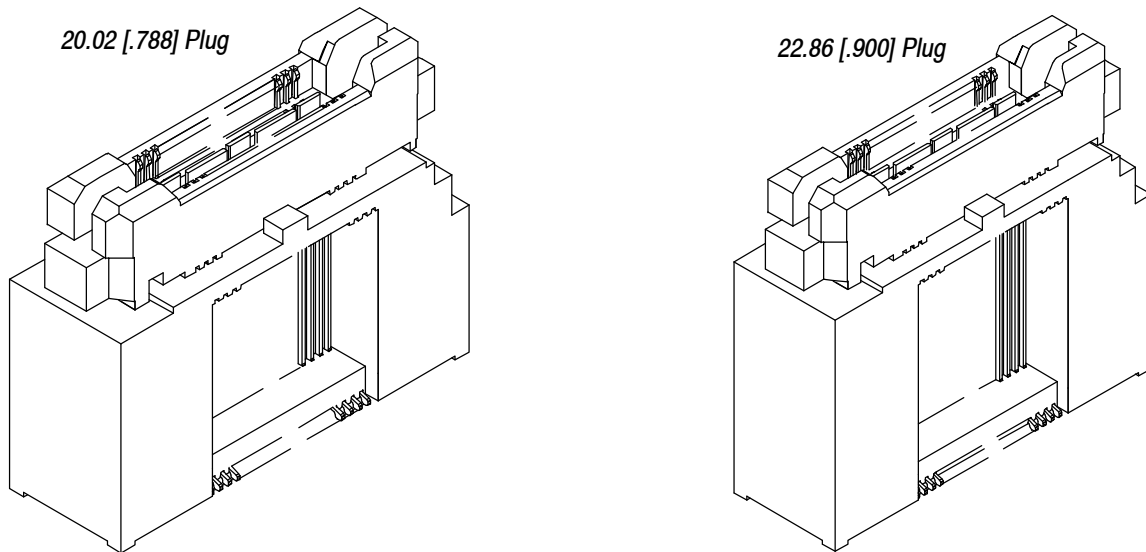

Figure 1 (end)

## 2. REFERENCE MATERIAL

### 2.1. Revision Summary

This paragraph is reserved for a revision summary covering the most recent additions and changes made to this specification which include the following:

- Updated document to corporate requirements
- New logo

### 2.2. Customer Assistance

Reference Part Number 767004 and Product Code 2429 are representative of MICTOR Plug and Receptacle Connectors. These numbers are used in a service network of customer service to access tooling and product application information. This service is provided by your local TE Representative or, after purchase, by calling the Tooling Assistance Center or the Product Information number at the bottom of page 1.

### 2.3. Engineering Drawings

Customer Drawings for specific products are available from the responsible TE Engineering Department via the service network. The information contained in the Customer Drawing takes priority if there is a conflict with this specification or any other technical documentation supplied by TE.

### 2.4. Specifications

#### A. Application Specification

Application Specification 114-13088 provides application requirements for MICTOR Right-Angle Connectors for SMT PC Board Applications

#### B. Product Specifications

Product Specifications 108-1422 and 108-1422-1 provide product performance requirements and test information.

#### C. Test Specification

Solderability Specification 109-11-1 provides requirements and evaluation methods.

### 2.5. Manuals

Manual 402-40 is available upon request and can be used as a guide in soldering. This manual provides information on various flux types and characteristics along with the commercial designation and flux removal procedures. A checklist is attached to the manual as a guide for information on soldering problems.

### 3. REQUIREMENTS

#### 3.1. Product Materials

MICTOR Connector Housings are constructed of a high temperature thermoplastic – Liquid Crystal Polymer, UL94V-0. The plug and receptacle signal contacts are made of high reliability copper alloy, and the ground buses are made from brass and phosphor bronze. The mating interface of the signal contacts and ground buses are underplated with nickel and finished with gold plating or palladium nickel with gold flash. The solder leads and tines have 60/40 matte tin-lead or matte tin plating.

#### 3.2. Storage

Connectors are packaged and shipped in protective anti-static tubes or pocket tape which can be used for automated placement of the connector to the pc board. Connectors should remain in the containers until ready for use to prevent physical damage to the housings and contacts. The connectors should be used on a first in, first out basis to avoid storage contamination that could adversely affect signal transmissions and solderability of the contact tines.

#### 3.3. Polarization

Both the vertical plug and receptacle connectors are prevented from reverse mating by an orientation feature located at the end of the connector that interfaces with the orientation hole in the pc board. See Figure 1.

#### 3.4. Circuit Identification

Vertical plugs and receptacles are marked with a No. 1 pin identifier. See Figure 1.

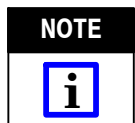

*There is no industry standard for the callout of the part number numbering sequence for MICTOR Connectors. It is up to customer discretion. However, the most common method is to start with pin number 1 and continue the numbering sequence (1, 2, 3, 4, etc.) down that side of the connector, then continue directly opposite the number 1 pin on the other side to number the pins to the other end of the connector.*

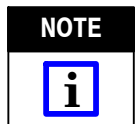

*MICTOR Connectors come in 38-position increment sizes (19 signal contacts per side). Each 38-position increment has five ground bus solder leads that are commoned internally with the connector.*

#### 3.5. Spacing

##### A. Connector Alignment



*TE does not recommend the use of more than two mating pairs of connectors between two pc boards; if more than two pairs of mating connectors are necessary to meet design requirements, consult the Product Information number located at the bottom of page 1.*

In applications involving multiple connectors per pc board, special attention must be paid to ensure the orientation of connectors on one pc board are correctly matched to the connectors on the mating board. Connectors can be placed in close proximity to each other on the pc board. The dimensions provided do NOT include space needed for other pc board components or robotic tooling. Check spacing requirements for other components before making your placement layout on the pc board. Figure 2 provides recommended placement variations to ensure vertical board-to-board plug and receptacle mating and unmating.

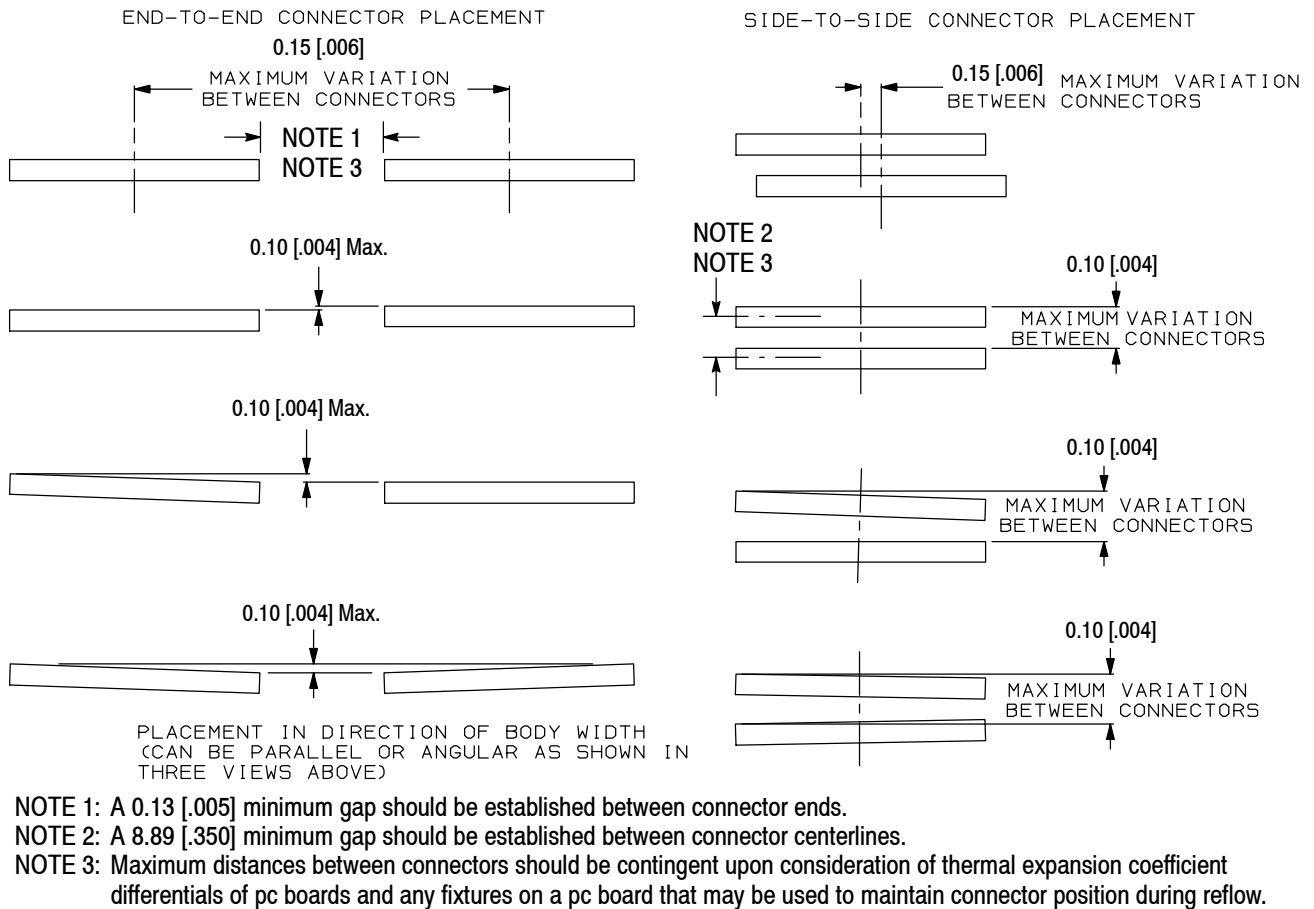
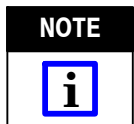

Figure 2

**B. Board-to-Board Spacing**

Board-to-board stacking heights for the MICTOR Vertical Connectors are provided in Figure 3.



The dimension provided does not include the paste thickness between the solder tines and solder pads of both connectors.

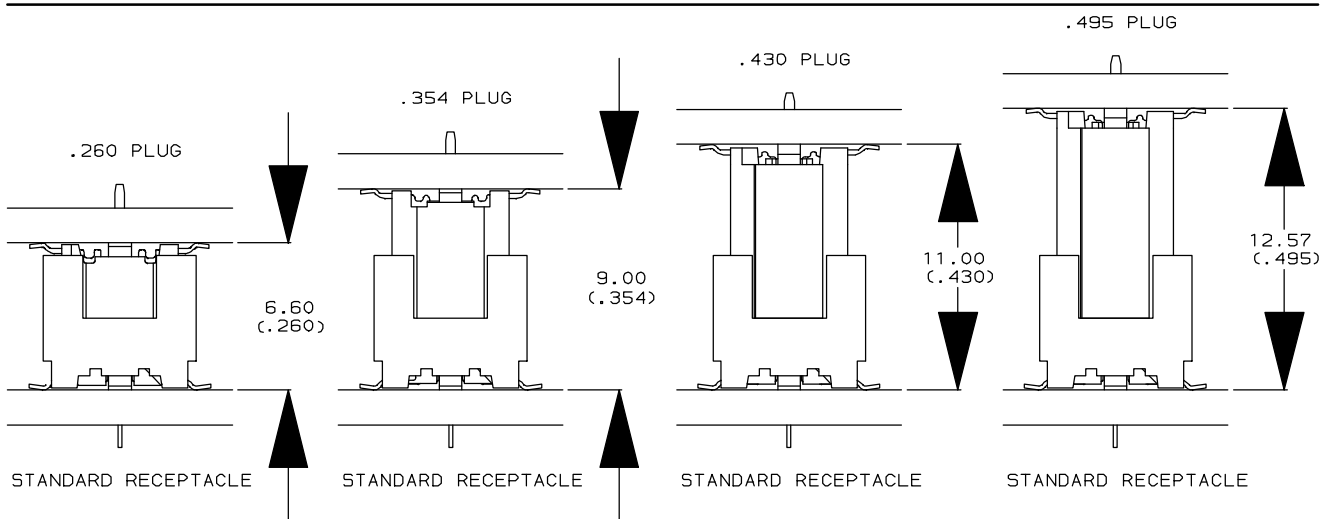

Figure 3 (cont'd)

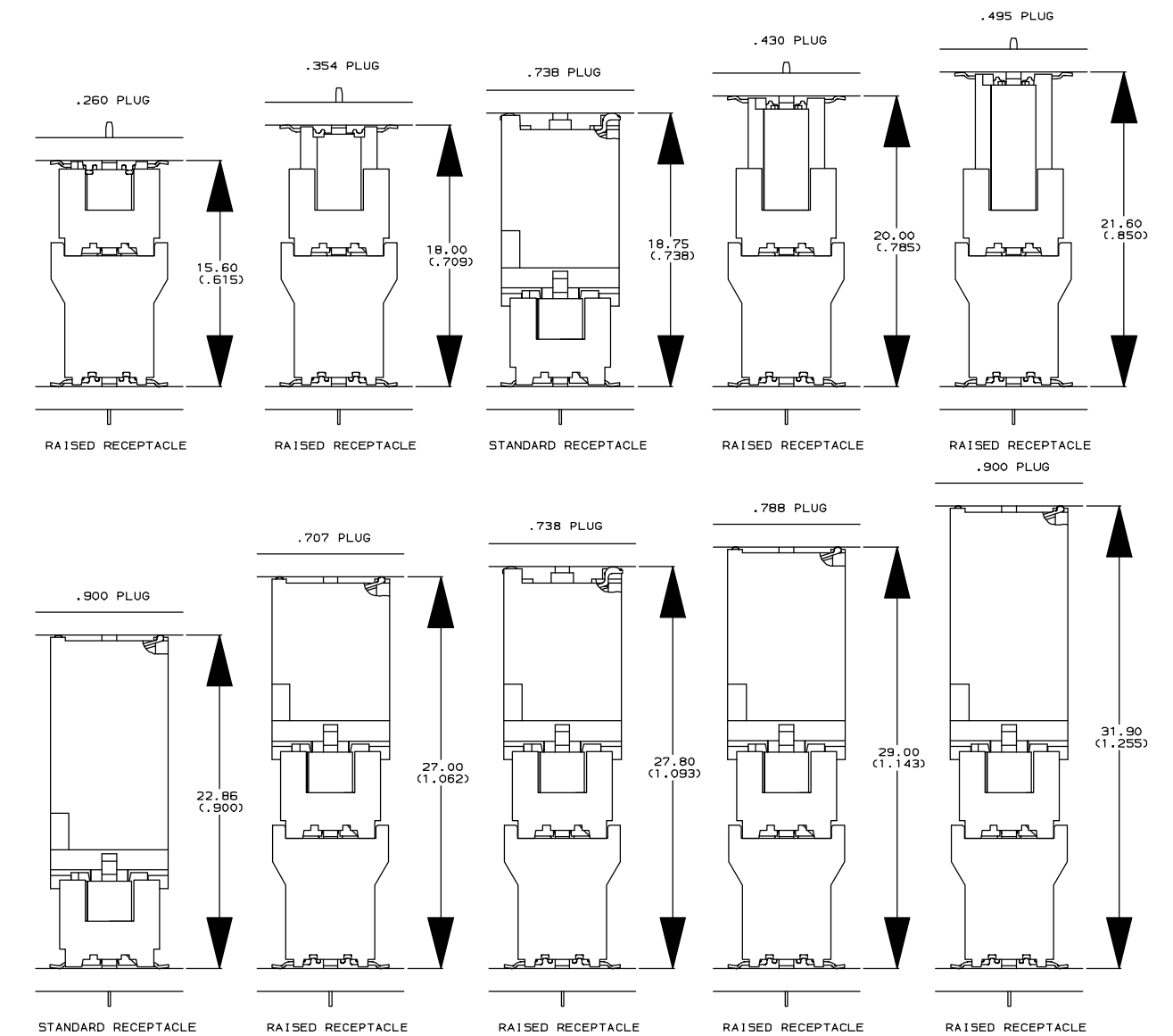

Figure 3 (end)

### 3.6. PC Boards for MICTOR Connectors

#### A. Tolerance

At the time of connector placement, the coplanarity of the pad pattern must be held to 0.05 [.002] maximum. We recommend a solder mask to minimize solder bridging between pads. The mask must not exceed the height of the pad by more than 0.05 [.002]. Maximum allowable bow of the pc board shall be 0.10 [.004] over the length of the connector.



Since the connector housings may rest on top of the solder mask, an excessively high mask will allow too much space between the solder time and pad for a good solder joint. A solder joint under these conditions would be weak, and would not provide long term performance for the connector.

#### B. Material and Thickness

PC board material shall be glass epoxy (FR-4 or equivalent) and have nominal thickness of  $1.57 \pm 0.15$  [.062  $\pm$  .006] or  $2.36 \pm 0.20$  [.093  $\pm$  .008] to ensure good interconnection to the pc board with and without hold-downs. There is no limit on maximum thickness (connectors are intrusive solder reflowed). Call the Product Information number at the bottom of page 1 for suitability of other materials or thicknesses. A solder mask is recommended when soldering connectors. Those most suitable are Liquid Photo Imageable and Dry Film.

### C. PC Board Layout

Recommended pc board patterns for groupings of all vertical connectors with 0.64 [.025] centerlines are provided in Figure 4. These layouts are viewed from the connector side.

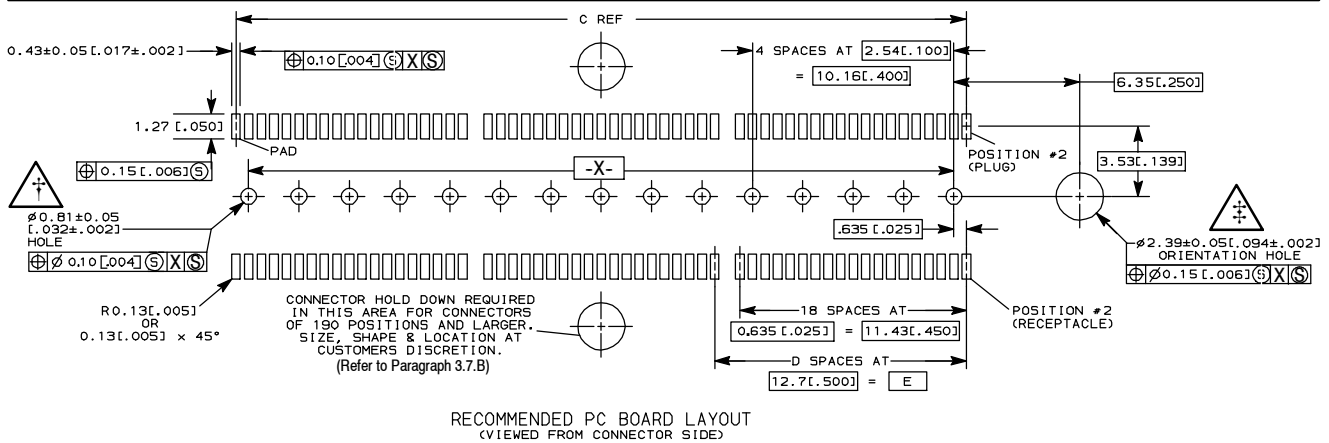

RECOMMENDED PC BOARD LAYOUT FOR MICTOR 0.64 [.025] VERTICAL PLUG & RECEPTACLE CONNECTORS

- The 0.81 [.032] diameter holes are for all MICTOR Connectors with barbed ground bus leads and barbless plugs. Barbless receptacles require 0.64 ±0.05 [.025 ±.002] diameter holes.
- A 2.00 ±0.03 [.079 ±.001] orientation hole is recommended for barbless ground bus connectors intended to be placed on pc boards by hand.

**CAUTION:** Hold down holes should be placed along the sides of connectors, biased toward the middle of the connector's length. Placing holes at the ends of the connectors may cause the ends of the connectors to act as fulcrum points to pry apart the opposite end or mid-portion of the connector as the hold down is tightened.

The maximum tip-to-tip lead length dimension for vertical plugs and receptacles is 8.72 [.343]. Although this is wider than the recommended 8.33 [.328] solder pad edge-to-edge distance, it is correct. The recommended pad lengths and locations are designed to centrally locate the connector lead heels on the pads to ensure good solder joints on the inside of the heels where they need the most strength. The maximum tip-to-tip lead dimension is given to provide real estate information to the pc board designer.

**NOTE:** Annular ring widths of 0.165 [.0065] in diameter around bus tine openings is recommended to minimize potential for solder bridging.

BUS TINES TYPE	PC BOARD THICKNESS	NO. OF POSITIONS	DIMENSION "C"	DIMENSION "D"	DIMENSION "E"
STANDARD	1.37 [.054] Min. 1.57 [.062] Nom. 2.36 [.093] Nom.	266	87.63 [3.450]	6	76.2 [3.000]
		228	74.93 [2.950]	5	63.5 [2.500]
		190	62.23 [2.450]	4	50.8 [2.000]
		152	49.53 [1.950]	3	38.1 [1.500]
		114	36.83 [1.450]	2	25.4 [1.000]
		76	24.13 [.950]	1	12.7 [.500]
		38	11.43 [.450]	0	0 [.000]

Figure 4



TE does not recommend the use of more than two mating pairs of connectors between two pc boards; if more than two pairs of mating connectors are necessary to meet design requirements, consult the Product Information number located at the bottom of page 1.

### 3.7. Mechanical Supports

#### A. Connector Assembly Insertion

The bus tines have a retention feature that requires some force for the connector to be applied to the pc board. To ensure the pc board does not bow due to this load and a misapplication occurs, the pc board should be supported along the full length of the connector. If the bus tines extend through the pc board, there should be an allowance for clearance below the 0.81 [.032] diameter plated holes for the bus tines.

#### B. Hold-Downs

For vertical connectors having 190 positions and greater, at least one hold-down fastener to the chassis near the midpoint of the connector body is required to protect the solder joints of the connector and surrounding components and to ensure good mating wipe. Holes for these hold-downs may also be used for tooling to hold parts in place during the solder reflow operation. This is also recommended for 190 positions and larger vertical connectors.

The anchor style, size, and exact location are determined by the customer's discretion. However, it is recommended these hold-downs be limited in location to either side of the connector. Placing hold-downs in line with connectors at either end may result in the ends of the connector housings functioning as fulcrum points to pry apart the middle of the connectors. The designer should consider the mating and unmating forces as referenced in product specifications 108-1422 and 108-1422-1.

### 3.8. Processing

MICTOR Connectors utilize hybrid style surface mount solder leads. The signal contact leads are true surface mount leads, while the ground bus contacts have through-hole style leads. Connectors are typically processed using the intrusive solder reflow technique. Solder paste is deposited over the ground bus lead holes at the same time it is placed on the signal lead pads. The ground bus leads are pressed through the solder paste as the connectors are placed on the pc boards. The solder is drawn into the holes as the connector is exposed to reflow temperatures.

#### NOTE

*PC Boards must meet the solderability requirements of IEC 60512-12-1 (512-6: 1984 Test 12a).*



#### A. Stencil

The stencil aperture is determined by the circuit pad size and stencil thickness. It may be any shape as long as it prevents solder bridging from one pad to another. Generally, the thinner stencil will need a larger aperture to maintain the given volume of solder paste. The formulas for calculating the apertures are:

Vertical Plug and Receptacle Stencil (Reference Figure 5)

Volume of paste deposit per pad for contact =  $0.082 \text{ mm}^3$  [.000005 in<sup>3</sup>]

Volume of paste deposit per bus tine opening =  $0.502 \text{ mm}^3$  [.00003 in<sup>3</sup>]

Width of pc board contact circuit pad = 0.43 mm [.017 in]

Width of bus tine opening = 2.03 mm [.080 in]

Area of stencil aperture of contact circuit pad =  $1.27 \times 0.43 = 0.55 \text{ mm}^2$   
 $[\.050 \times \.017 = \.0009 \text{ in}^2]$

Area of stencil aperture of bus tine opening =  $2.03 \times 1.65 = 3.35 \text{ mm}^2$   
 $[\.080 \times \.065 = \.005 \text{ in}^2]$

Length of stencil aperture of contact circuit pad = 1.27 mm [.050 in]

Length of stencil aperture of bus tine opening = 1.65 mm [.065 in]

#### CAUTION



*All traces must be covered by solder mask in the solder deposit area. Exposed traces could cause bridging and create a short, or wick solder away from the solder tines, producing a weak solder joint.*





If a hold-down aperture is required other than that specified, the design must ensure that the connector housing will not sit on the solder deposit.

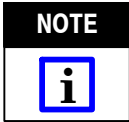

The recommended aperture width is 0.43 [.017] for the vertical connector circuit contact pads. It may be wider; however, care must be given to ensure against solder bridging during processing.

The recommended solder stencil layouts for MICTOR SMT Connectors are shown in Figure 5.

Vertical Connectors  
0.64 [.025] Center Line  
38-Position Shown

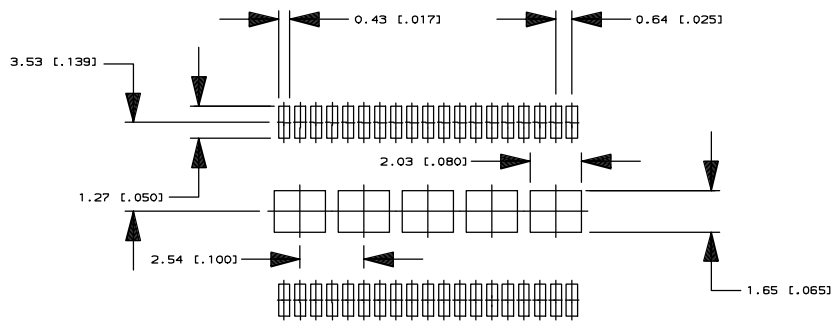

Figure 5

**B. Solder Mask**

Solder mask is recommended between all pads, ground bus vias, and angular rings. If a trace is run between adjacent pads on the solder side of the pc board, a solder mask **MUST** be applied over the trace to prevent bridging and wicking of solder away from the contact solder tines. Additionally, there should be solder mask covering any traces in the area surrounding the bus lead solder deposit. Liquid photo imageable or dry film solder masks, in step with modern processing techniques are recommended.

**C. Recommended Solder Paste Characteristics**

1. Alloy type shall be either 63Sn/37Pb or 60Sn/40Pb for connectors with Sn/Pb plated leads; or 95.5Sn/4.0Ag/0.5Cu for connectors with Sn plated leads.
2. Flux shall be RMA type.
3. Solids by weight shall be 85% minimum.
4. Mesh designation -200 to +325 (74 to 44 square micron openings, respectively).
5. Minimum viscosity of screen print shall be  $5 \times 10^5$  cp (centipoise).
6. Minimum viscosity of stencil print shall be  $7.5 \times 10^5$  cp (centipoise).

**D. Solder Volume**

Solder volume for each circuit pad and bus tine opening is calculated by multiplying the pad length by the pad width by the stencil thickness (Volume=LxWxT). The recommended volume for these connectors is determined with a mean stencil thickness of 0.15 [.006]:

1. Solder Volume on Vertical Plug, and Receptacle Circuit Pads
  - $1.27 \times 0.43 \times 0.15 = 0.082 \text{ mm}^3$  per pad
  - $[.050 \times .017 \times .006 = .000005 \text{ in}^3]$  per pad
2. Solder Volume on Vertical Plug, and Receptacle Bus Tine Openings
  - $2.03 \times 0.64 \times 0.15 = 0.502 \text{ mm}^3$  per opening
  - $[.080 \times .065 \times .006 = .00003 \text{ in}^3]$  per opening



Paste volumes in excess of those recommended could result in excessive solder wicking onto the solder tine, resulting in reduction of tine compliance and/or solder joint failure.

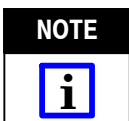









More technical information may be available from the manufacturer of the stencil.



## E. Connector Placement

### Vertical Connectors

The vertical plugs and receptacles are positioned on the pc board by matching the orientation feature on the bottom of the housing to the unplated hole. The bus tine tips are aligned with the plated vias and will initially enter these holes with no resistance. The bus tine will cause friction as it is pushed into the pc board. The force required to seat the connector should not exceed 6.67 N [1.5 pound] per 38 signal positions for the 0.64 [.025] centerline connector.

- NOTE**  Vertical connectors should only be placed on the pc board one time. The bus tines are the means of locating and retaining the connector to the pc board for the solder reflow process. Pulling the connector off the pc board after placement can damage the tines. An attempt to reuse the connector can likely result in misalignment of the signal tine to the surface mount pads because of the damage.
- CAUTION**  Connectors having 190 positions and larger that also have barbed leads should be pressed onto the pc board with uniform force over the length of the connector during placement. On standard receptacles and shorter height plugs, the barbed lead insertion forces of the larger position size parts may result in housing flex and the end positions not being fully depressed against the pc board when only pushing on the middle of the connector.
- CAUTION**  In applications involving robotic placement, signal leads should not be used as vision equipment reference points when placing connectors on pc boards in an attempt to centrally place signal leads on solder pads. Ground bus lead to pc board hole alignment problems may result. Ideally, the ground bus lead tips should be referenced to align them with their pc board holes. Once on the board, the ground bus leads serve to self-center the connector over the signal lead pads. In cases where it is too difficult to reference the ground bus leads, the housing width and length datum centerlines may be used to center the connector over the ground bus holes.
- NOTE**  The pc board should be firmly supported in the area directly beneath the connector during placement to prevent the pc board from flexing. Refer to Paragraph 5.1.
- NOTE**  When using vision equipment to verify signal lead position integrity, it is recommended that only those portions of the lead extend beyond the side of the housing should be used as reference points. Portions of the signal leads located directly under the signal contact (where they exit the housing bottom) may vary in plating color and cause problems with vision systems. The area directly below the signal contact is not considered part of the signal lead soldering surface. This area comprises the plating transition area between the tin/lead plating and the gold plating. It cannot be controlled to provide a uniform color that may be used for vision system evaluation.
- NOTE**  Connectors are available in shipping tubes or on tape reels and should be placed directly from the package to the pc board. TE does NOT recommend emptying them from the package into piles or in bowl feeders prior to placement.
- CAUTION**  Connectors should be handled only by the ends. DO NOT touch the solder tines, as moisture from the hands will contaminate the soldering process and lead position or coplanarity may be compromised.
- NOTE**  Optimally, the connector solder tines should be centered on the pc board pads. However, slight misalignment is permissible. See Figure 6.

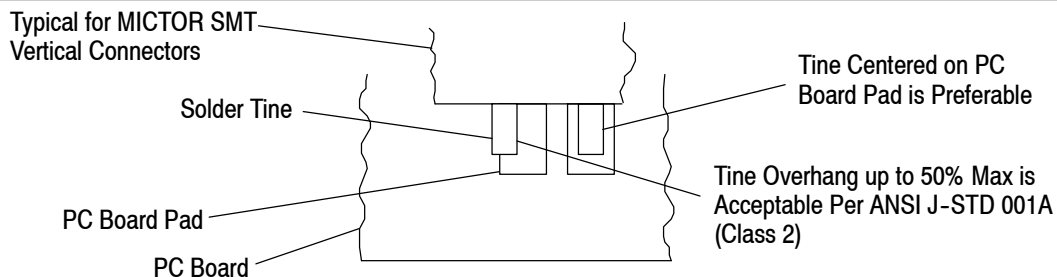

Figure 6

## F. Soldering

**NOTE**

Manual 402-40 provides some guidelines for establishing soldering practices.



### 1. Techniques

It is recommended that the connector be soldered using convection, vapor phase (VPR), double sided non-focused infrared (IR), or equivalent soldering technique provided the temperatures and exposure time are within the ranges specified in Figure 7.

SOLDERING PROCESS	TEMPERATURE		TIME (At Max Temp)
	CELSIUS	FAHRENHEIT	
<b>PARTS WITH TIN-LEAD PLATED LEADS</b>			
Vapor Phase Soldering	215	419	5 Minutes
Convection Reflow Soldering	230	446	5 Minutes
<b>PARTS WITH TIN PLATED LEADS</b>			
Vapor Phase Soldering	245	473	30 Seconds
Convection Reflow Soldering	260	500	30 Seconds

Figure 7

### 2. Connector Capacity

Connectors will withstand the maximum temperature time limits specified in Figure 7.

### 3. Reflow Parameters

Due to the many variables involved with the reflow process (ie, component density, orientation, etc), we recommend that the user conduct trial runs under actual manufacturing conditions to ensure product and process compatibility.

## G. Cleaning

After soldering, removal of fluxes, residues, and activators is necessary. Consult with the supplier of the solder paste and flux for recommended cleaning solvents. The following is a listing of common cleaning solvents that will not affect the connectors. The connectors will be unaffected by any of these solvents for 5 minutes at 105°C [221°F]. See Figure 8.

Cleaners must be free of dissolved flux and other contaminants. We recommend cleaning with the pc board on its edge. If using an aqueous cleaner, we recommend standard equipment such as a soak-tank or an automatic in-line machine

**CAUTION**

Even when using “no clean” solder paste, it is imperative that the contact interface be kept clean of flux and residue, since it acts as an insulator. Flux may migrate under certain conditions with elevated temperatures and, therefore, cleaning is necessary even with “no clean” paste.

CLEANER		TIME (Minutes)	TEMPERATURES (Maximum)	
NAME	TYPE		CELSIUS	FAHRENHEIT
Alpha 2110■	Aqueous	1	132	270
Bioact EC-7◆	Solvent	5	100	212
Butyl Carbitol●	Solvent	1	Room Ambient	
Isopropyl Alcohol	Solvent	5	100	212
Kester 5778■	Aqueous	5	100	212
Kester 5779■	Aqueous	5	100	212
Loncoterge 520●	Aqueous	5	100	212
Loncoterge 530●	Aqueous	5	100	212
Terpene Solvent	Solvent	5	100	212

Alpha, Bioact, Carbitol, Kester, and Loncoterge are trademarks of their respective owners.

Figure 8



**CAUTION** MICTOR Connectors are not designed to function as pc board stiffeners. Thermal flexing of the pc board will result in either the connector body following the pc board contour or lifting off the board.



**DANGER** Consideration must be given to toxicity and other safety requirements recommended by the solvent manufacturer. Trichloroethylene and Methylene Chloride can be used with no harmful affect to the connectors; however, TE does not recommend them because of the harmful occupational and environmental effects. Both are carcinogenic (cancer-causing) and Trichloroethylene is harmful to the earth's ozone layer.



**NOTE** If you have a particular solvent that is not listed, contact the Product Information number at the bottom of page 1.

**H. Drying**

Air drying of cleaned connectors is recommended. Temperature for the connectors should not exceed -55 to 105°C [-67 to 221°F]. Degradation of the housings could result from extreme temperatures.

**I. Checking Installed Connector**

The connector assembly should be soldered to the pc board as shown in Figure 9.

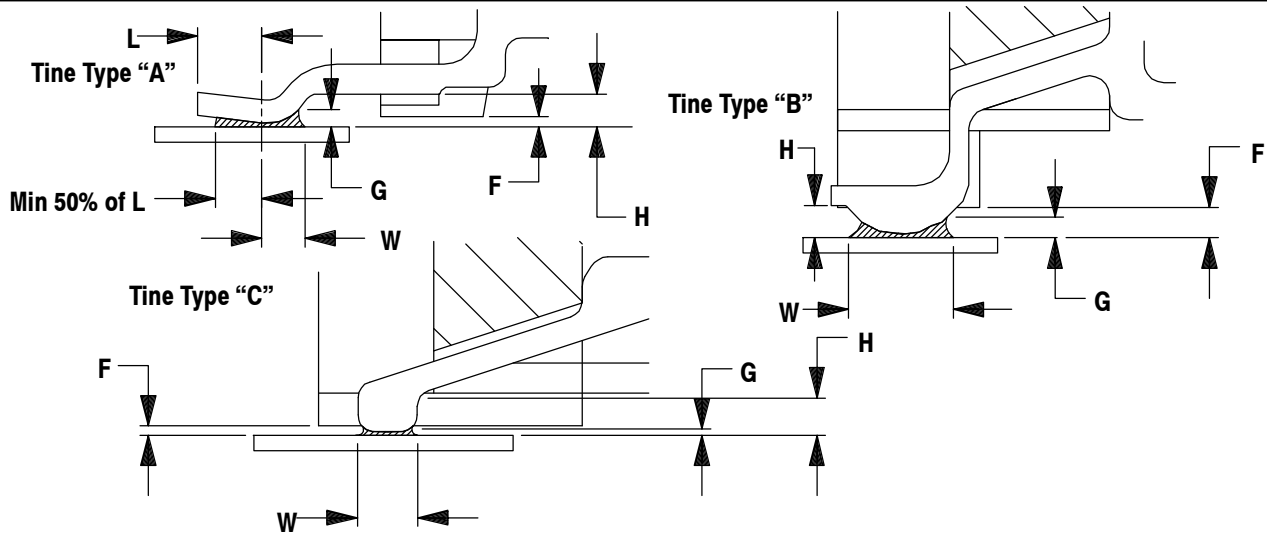

CONNECTOR TYPE	CONTACT TINE TYPE	DIMENSION				
		W (Min.)	H	F	G (Min.) FILLET HEIGHT	
					HEEL FILLET	SIDE FILLET
6.6 [.260] PLUG	A	0.28 [.011]	0.23 [.009]	0.10 [.004]	50% of H	▲
9.0 [.354] PLUG	A	0.28 [.011]	0.23 [.009]	0.13 [.005]	50% of H	▲
11.00 [.430] PLUG	A	0.28 [.011]	0.23 [.009]	0.13 [.005]	50% of H	▲
12.57 [.495] PLUG	A	0.28 [.011]	0.23 [.009]	0.13 [.005]	50% of H	▲
18.75 [.738] PLUG	B	0.76 [.030]	0.48 [.019]	0.13 [.005]	50% of H	15% of H
22.86 [.900] PLUG	C	0.71 [.028]	0.25 [.010]	0.18 [.007]	50% of H	15% of H
27.00 [1.062] PLUG	C	0.71 [.028]	0.25 [.010]	0.18 [.007]	50% of H	15% of H
29.00 [1.143] PLUG	C	0.71 [.028]	0.25 [.010]	0.13 [.005]	50% of H	15% of H
STANDARD RECEPTACLE	A	0.28 [.011]	0.23 [.009]	0.10 [.004]	50% of H	▲
RAISED RECEPTACLE	A	0.28 [.011]	0.23 [.009]	0.15 [.006]	50% of H	▲

▲ Noticeable wetting between tine and pad required.

Figure 9

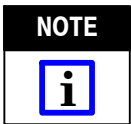

*Housing standoffs need not touch the pc board surface (reference F). Their function is to provide against signal lead damage caused by over-deflection during placement.*

When performing inspections, the bus tine solder joints should not be subjected to the same inspection criteria as traditional through hole components. A full fillet on the back side of the pc board is NOT required. The MICTOR Connector was designed and qualified as a surface mount processed component. By nature of the surface mount paste process, a full via and fillet are not required from a strength standpoint. Also, it is not required that the bus tine project below the back side of the pc board. See Figure 10.



*All MICTOR Connectors should have soldered ground bus leads. These leads are NOT designed for press-fit.*

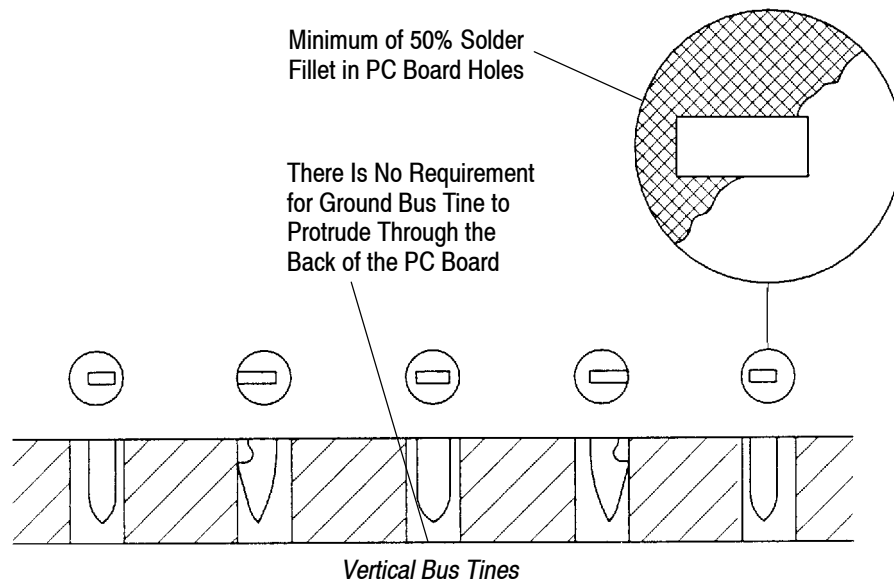

Figure 10

### 3.9. Mating and Unmating



*Uneven or off-angle forces during mating and unmating of MICTOR Connectors may cause overstress and damage to the contacts, housings or solder joints. Severe side-to-side rocking motions should be prohibited.*

Unmating MICTOR Connectors by lifting one end of the connector (peeling) is permitted. However, this should only be done to initiate separation of the mated contacts at one end of the connector. The separation angle should be kept as low as possible as the contacts continue to unmate, thereby spreading out the unmating forces over the length of the connectors. The connectors should not be “peeled” beyond a 20° angle.

Miniaturization is a design feature of these connectors and the systems in which they are used. Component density, connector location, and pc board size may make it difficult to remove the connector. Two methods are recommended to facilitate removal. If unmating board-to-board connectors, the preferred method is to have one of the pc boards securely fastened and adequately supported to withstand the pulling force applied to the other pc board. The second method is to construct a tool for your system design that will produce a straight-away separation of the connectors. See Figure 11.



*Application of unmating forces to the pc boards should be done within close proximity of the connector (preferably within 25.4 [1.000] on 1.57 [.062] thick pc boards). Stress on the solder joints will increase as the force is applied further from the connector.*

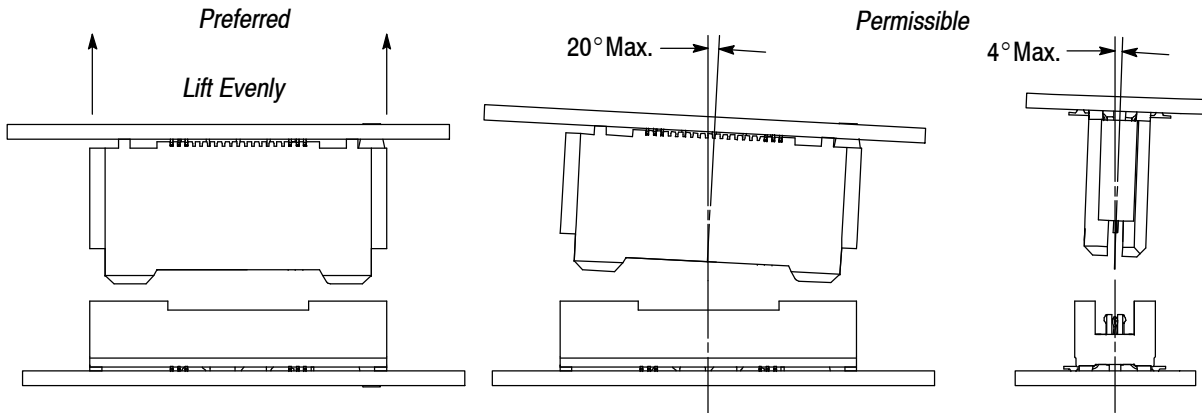

Figure 11

### 3.10. Repair/Removal

Connectors may be removed from the pc board by standard de-soldering methods. Damaged connectors must be replaced.

Suppliers of removal equipment for MICTOR Vertical Connectors are as follows:

Automated Production Equipment Corp.  
142 Peconic Ave.  
Medford, NY 11763  
(516) 654-1197

Air Vac Engineering  
30 Progress Ave.  
Seymour, CT 06483  
(203) 888-9900  
www.air-vac-eng.com

Conceptronic Incorporated  
6 Post Rd.  
Portsmouth, NH 03801  
(603) 431-6262

## 4. QUALIFICATIONS

MICTOR Connectors have been Recognized by Underwriters Laboratories (UL) in file No. E28476, and Certified by CSA International in Certificate No. 7189A-852.

## 5. TOOLING

### 5.1. PC Board Support

A pc board support must be used to prevent bowing of the pc board during the placement of a connector on the board. It should have flat surfaces with holes or a channel large enough to clear the bus leads. Refer to Figure 12.

### 5.2. Robotic Equipment

MICTOR Connectors are pick-and-place compatible. They are normally packaged in tubes, but vertical receptacles and plugs are also available in pocket tape (with or without vacuum pick-up caps). MICTOR Vertical Receptacles and Plugs may be applied using robotic grippers or vacuum heads.

Robotic placement equipment should be capable of accurately locating connectors for pc board insertion using the connector datum surfaces detailed on the customer drawing. Several robotic companies have experience with placing MICTOR Connectors and can be called upon for assistance. They are:

---

Universal Instruments Corporation  
P.O. Box 825  
Binghamton, NY 13902  
(607) 779-7522  
www.uic.com

Panasonic Factory Automation  
9377 West Grand Ave.  
Franklin Park IL 60131  
(847) 288-4400  
www.panasonicfa.com

Robodyne  
2818 Anthony Lane South  
Minneapolis, MN 55418  
(612) 789-5277  
www.robodyne.com

Fuji America Corporation  
171 Corporate Woods Parkways  
Vernon Hills, IL 60061  
(847) 913-0162  
www.fujiamerica.com

---

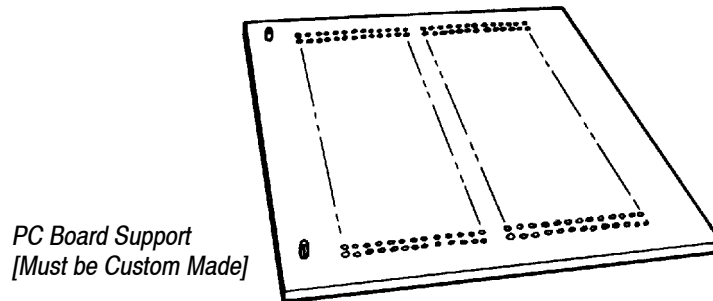

---

Figure 12

## 6. VISUAL AID

Figure 13 shows a typical application of MICTOR SMT Connectors. This illustration should be used by production personnel to visually ensure suitable applications. Installations which appear visually incorrect should be inspected using the dimensional information given in the preceding pages of this application specification.

**NOTE: PIN NUMBER 1 IDENTIFIER AND THE NUMBER 1 LOCATOR ON THE PC BOARD FOOTPRINT MUST BE ALIGNED PRIOR TO MOUNTING.**

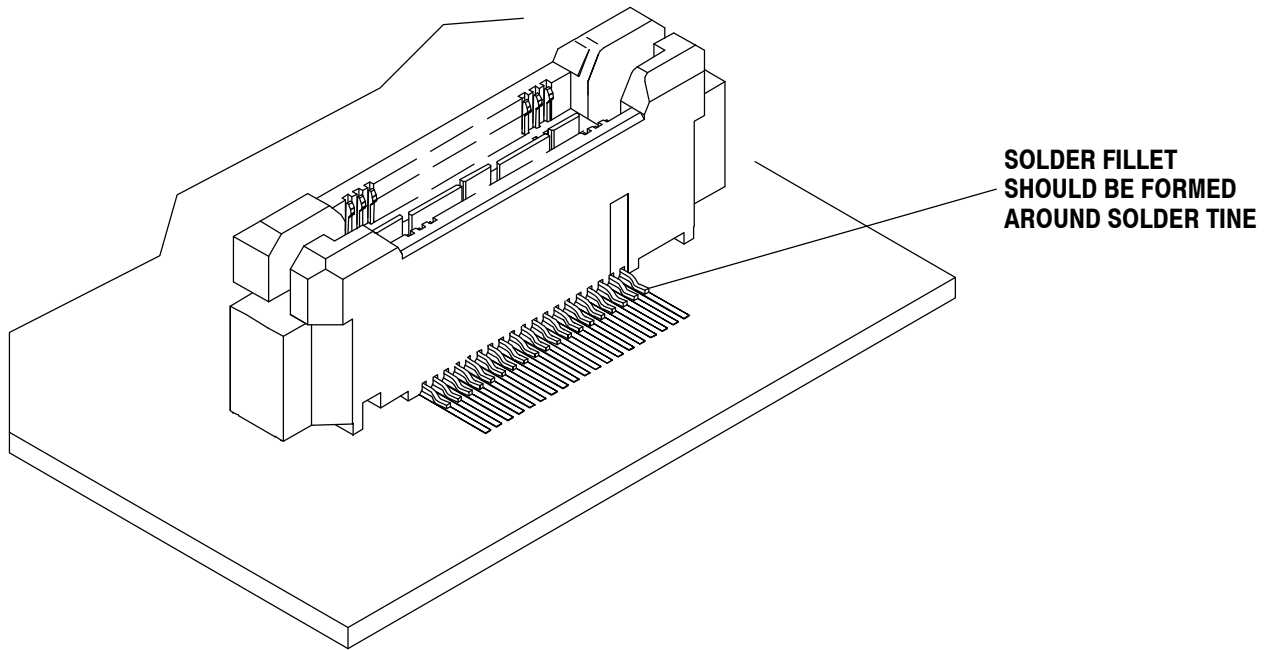

**FIGURE 13. VISUAL AID**