

108-5319

NUMBER:

Customer  
ReleaseSECURITY  
CLASSIFICATION:

## Product Specification

108-5319

## 3-Position, 250 Series, Tab Receptacle Interlock Connector

1. Scope :
- 1.1 Contents

This specification covers the requirements for product performance, test methods and quality assurance provisions of 3-Position, 250 Series, Tab Receptacle Interlock Connector.

The applicable product descriptions and part number are as shown below.

Product Part No.	Descriptions	Remarks
X-176773-X	3-Position, Cap Housing	
X-176774-X	3-Position, Plug Housing	
X-170384-X	250 Series, Receptacle Contact	Applicable Wire 0.3-0.5 mm <sup>2</sup>
X-170032-X	250 Series, Receptacle Contact	Applicable Wire 0.5-2.0 mm <sup>2</sup>
X-170258-X	250 Series, Receptacle Contact	Applicable Wire 2.0-3.0 mm <sup>2</sup>
X-170349-X	250 Series, Receptacle Contact	Applicable Wire 0.3-0.5 mm <sup>2</sup>
X-170340-X	250 Series, Tab Contact	Applicable Wire 0.5-2.0 mm <sup>2</sup>
X-170341-X	250 Series, Tab Contact	Applicable Wire 2.0-3.0 mm <sup>2</sup>

2. Requirements :
- 2.1 Design and Construction :

Product shall be of the design, construction and physical dimensions specified in the applicable product drawing.

- 2.2 Materials :

- A. Contact: Brass, conforming to Alloy 260 of ASTM B36, Copper Alloys
- B. Housing: 6/6 Nylon UL 94 V-0

DR. A.IMAI	SHEET 1 OF 8				
CHK. Y.FUJITA					
APP. N.ONOUE	NAME 3-Position, 250 Series, Tab Receptacle Interlock Connector				

PRINT  
DEST.

108-5319

NUMBER:

Customer Release

SECURITY CLASSIFICATION:

2.3 Ratings:

A. Voltage Rating: 300 VAC

B. Current Rating:

Wire Size (mm <sup>2</sup> )	0.3	0.5	0.75	1.25	2.0	3.0
Rated Current (A)	6	9	12	15	17	20

The creeping distance of the applied product shall be conforming to the requirements specified in Appendix Table No. 2 of Data Chart No. 8. of Electric Appliance Control Law of Japan, where it is specified as following:

1) Electrically charged distance between the different polarity....3 mm

2) Between the charged area and the ground.....2.5 mm

It is considered applicable that plug housing is applied on the power source side, and cap housing on the application side.

2.4 Performance and Test Descriptions:

The product shall be designed to meet the electrical, mechanical and environmental performance requirements specified in Fig. 1. All tests are performed in the room temperature unless otherwise specified.

2.5 Test Requirements and Procedures Summary:

Para.	Test Items	Requirements	Procedures																														
2.5.1	Confirmation of Product	Product shall be conforming to the requirements of applicable product drawing	Visually, dimensionally and functionally inspected per applicable inspection plan.																														
Electrical Requirements																																	
2.5.2	Termination Resistance (Specified Current)	<table border="1"> <thead> <tr> <th colspan="2">Wire Size</th> <th rowspan="2">Test (A) Current</th> <th rowspan="2">Millivolt Drop V/A max.</th> </tr> <tr> <th>mm<sup>2</sup></th> <th>(AWG)</th> </tr> </thead> <tbody> <tr> <td>0.3</td> <td>(#22)</td> <td>3</td> <td>0.0</td> </tr> <tr> <td>0.5</td> <td>(#20)</td> <td>4</td> <td>12.0</td> </tr> <tr> <td>0.75</td> <td>(#18)</td> <td>7</td> <td>21.0</td> </tr> <tr> <td>1.25</td> <td>(#16)</td> <td>10</td> <td>30.0</td> </tr> <tr> <td>2.0</td> <td>(#14)</td> <td>15</td> <td>45.0</td> </tr> <tr> <td>3.0</td> <td>(#12)</td> <td>20</td> <td>60.0</td> </tr> </tbody> </table>	Wire Size		Test (A) Current	Millivolt Drop V/A max.	mm <sup>2</sup>	(AWG)	0.3	(#22)	3	0.0	0.5	(#20)	4	12.0	0.75	(#18)	7	21.0	1.25	(#16)	10	30.0	2.0	(#14)	15	45.0	3.0	(#12)	20	60.0	Measure Initial millivolt drop of contact test circuit in mated connectors, Fig. 3
		Wire Size		Test (A) Current			Millivolt Drop V/A max.																										
		mm <sup>2</sup>	(AWG)																														
		0.3	(#22)	3	0.0																												
		0.5	(#20)	4	12.0																												
		0.75	(#18)	7	21.0																												
1.25	(#16)	10	30.0																														
2.0	(#14)	15	45.0																														
3.0	(#12)	20	60.0																														

Fig. 1 (To be continued)

SHEET				
	2 OF 8	LOC J	LOC A	NO. 108-5319
NAME 3-Position, 250 Series, Tab Receptacle Interlock Connector				

SECURITY CLASSIFICATION: Customer Release NUMBER: 108-5319	Para.	Test Items	Requirements	Procedures	
	2.5.3	Termination Resistance (Low Level)	10 mΩ max. (Final)	Subject mated contact assembled in housing to closed circuit current of 50 mA max. at open circuit voltage of 50 mV max. Fig. 3.	
	2.5.4	Dielectric Strength	Connector must withstand test potential of 2.2 kVAC for 1 minute. Current leakage must be 5 mA max.	Measure by applying test potential between the adjacent contacts, and between the contacts and ground in the mated connectors.	
	2.5.5	Insulation Resistance	100 MΩ min. (Initial)	Measure by applying test potential between the adjacent contacts, and between the contacts and ground in the mated connector. MIL-STD-202, Method 302, Condition B.	
	<b>Physical Requirements</b>				
	2.5.6	Vibration Sinusoidal Low Frequency	No electrical discontinuity greater than 100 microsecond (s) shall occur. Termination Resistance : (Specified Current) (Final) 10 mV/A max.	Subject mated connectors to vibration of 3.3 Hz, 4.5 G, on vibration test machine for 200 hours. During the test, vibrating axes are changed in turns of axial and traverse directions every other 50 hours. Refer to Fig. 4.	
	2.5.7 (1)	Connector Mating Force	9.0 kg max. (Initial) per contact	Using autograph, measure the force required to mate connector not using locking latch by operating at 100 mm a minute. Calculate the value for a contact.	
Fig. 1 (to be continued)					
SHEET					
3 OF 8		LOC J	LOC A	NO. 108-5319	
		REV. D1			
NAME 3-Position, 250 Series, Tab Receptacle Interlock Connector					

SECURITY CLASSIFICATION: Customer Release NUMBER: 108-5319	Para.	Test Items	Requirements	Procedures																								
	2.5.7 (2)	Connector Unmating Force	2.0 kg min. (Initial) per contact	Using autograph measure the force required to unmate connector without locking latch set in effect, by operating at 100 mm a minute. Calculate value for a contact.																								
	2.5.8	Contact Retention Force	6.0 kg min.	Apply axial load contact by operating at a rate of 100 mm a minute.																								
	2.5.9	Contact Mating Force	39.2N Max.	Measure force to mate contact by operating the head at a rate of 100 mm a minute.																								
	2.5.10	Contact Unmating Force	4.9~39.2N	After having contact mated with the counterpart contact, measure the force required to unmate by operating at a rate of 100 mm a minute.																								
	2.5.11	Crimp Tensile Strength	<table border="1"> <thead> <tr> <th colspan="2">Wire Size</th> <th>Crimp Tensile (min.)</th> </tr> <tr> <th>mm<sup>2</sup></th> <th>(AWG)</th> <th>kg</th> </tr> </thead> <tbody> <tr> <td>0.3</td> <td>(#22)</td> <td>8</td> </tr> <tr> <td>0.5</td> <td>(#20)</td> <td>9</td> </tr> <tr> <td>0.75</td> <td>(#18)</td> <td>13</td> </tr> <tr> <td>1.25</td> <td>(#16)</td> <td>18</td> </tr> <tr> <td>2.0</td> <td>(#14)</td> <td>21</td> </tr> <tr> <td>3.0</td> <td>(#12)</td> <td>30</td> </tr> </tbody> </table>		Wire Size		Crimp Tensile (min.)	mm <sup>2</sup>	(AWG)	kg	0.3	(#22)	8	0.5	(#20)	9	0.75	(#18)	13	1.25	(#16)	18	2.0	(#14)	21	3.0	(#12)	30
Wire Size			Crimp Tensile (min.)																									
mm <sup>2</sup>	(AWG)		kg																									
0.3	(#22)		8																									
0.5	(#20)		9																									
0.75	(#18)		13																									
1.25	(#16)		18																									
2.0	(#14)	21																										
3.0	(#12)	30																										

Fig. 1 (to be continued)

SHEET				
4 OF 8	LOC J	LOC A	NO. 108-5319	REV. D1
NAME 3-Position, 250 Series, Tab Receptacle Interlock Connector				

SECURITY CLASSIFICATION: Customer Release NUMBER: 108-5319	Para.	Test Items	Requirements	Procedures
	Environmental Requirements			
	2.5.12	Humidity, Steady State	Insulation Resistance (Final) 100 MΩ min. Termination Resistance (Low Level) (Final) 10 mΩ max.	Subject mated connectors to steady state humidity at 60 °C and 90-95 % R.H. for 96 hours.
	2.5.13	Temperature Life	Termination Resistance (Low Level) (Final) 10 mΩ max.	Subject mated connectors to temperature life ; test atmosphere at 120 ± 3 °C for 120 hours in the test chamber.
2.5.14	Resistance to Cold	Termination Resistance (Low Level) : 10 mΩ max. (Final)	Subject mated connectors to chilling temperature at -50 °C in the test chamber for 120 hours.	

Fig. 1 (end)

SHEET	 Tyco Electronics		
5 OF 8	LOC J	LOC A	NO. 108-5319
REV. D1			
NAME 3-Position, 250 Series, Tab Receptacle Interlock Connector			

Test of Examination		Test Group (a)									
		1	2	3	4	5	6	7	8	9	10
		Test Sequence (c)									
2.5.1	Examination of Product	1	1	1	1	1	1	1	1	1	1
2.5.2	Termination Resistance, Specified Current	2						3			
2.5.3	Termination Resistance, Dry Circuit								3	3	3
2.5.4	Dielectric Withstanding Voltage		2								
2.5.5	Insulation Resistance	3							4		
2.5.6	Vibration							2(b)			
2.5.7 (1)	Connector Mating Force						2				
2.5.7 (2)	Connector Unmating Force						3				
2.5.8	Contact Retention Force					2					
2.5.9	Contact Mating Force				2						
2.5.10	Contact Unmating Force				3						
2.5.11	Crimp Tensile Strength			2							
2.5.12	Humidity, Steady State								2		
2.5.13	Temperature Life									2	
2.5.14	Resistance to Cold										2

(a) See Para 4.1.A.

(b) Discontinuities shall not take place in this test group during tests.

(c) Numbers indicate sequence in which tests are performed.

Fig. 2

SHEET	 Tyco Electronics			
6 OF 8	LOC J	LOC A	NO. 108-5319	REV. D1
NAME	3-Position, 250 Series, Tab Receptacle Interlock Connector			

NUMBER:  
108-5319

SECURITY CLASSIFICATION:

Customer Release

SECURITY CLASSIFICATION:   
 Customer Release   
 NUMBER: 108-5319

2.7 Measuring Method :

Termination Resistance (Specified Current)

Apply test current of specified intensity as shown in Para. 2.5.2 to the mated connectors as shown in Fig. 3. Measure millivolt drop of the circuit by probing between Y-Y' with the use of millichmmeter after the temperature rise of the circuit becomes stabilized. The termination resistance of the wire crimp and frictional contact area of a contact is obtained by calculation, after deducting the resistance of 150 mm long wire used for termination.

The probing points, Y and Y' are determined by measurement of the distance from the rear end of the crimped contact, and such points are soldered for uniformity of current flowing density for probing, after removal of wire insulation sufficiently for the wire preparation.

Termination resistance (low level) is measured by applying closed circuit current of 50 mA maximum at open circuit voltage of 50 mV maximum flowing through the circuit.

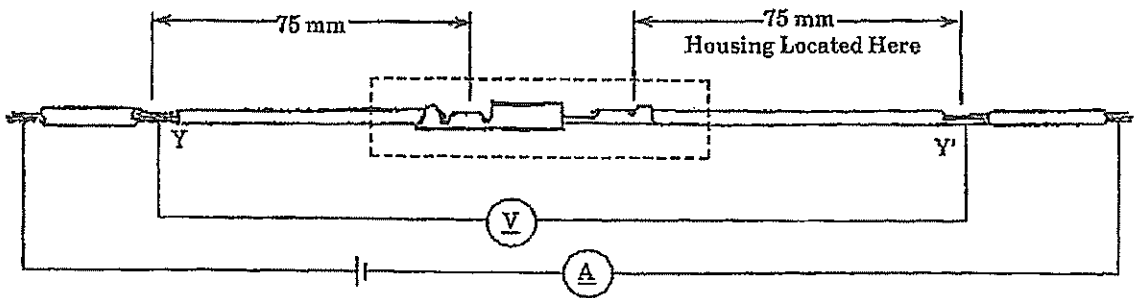

Fig. 3

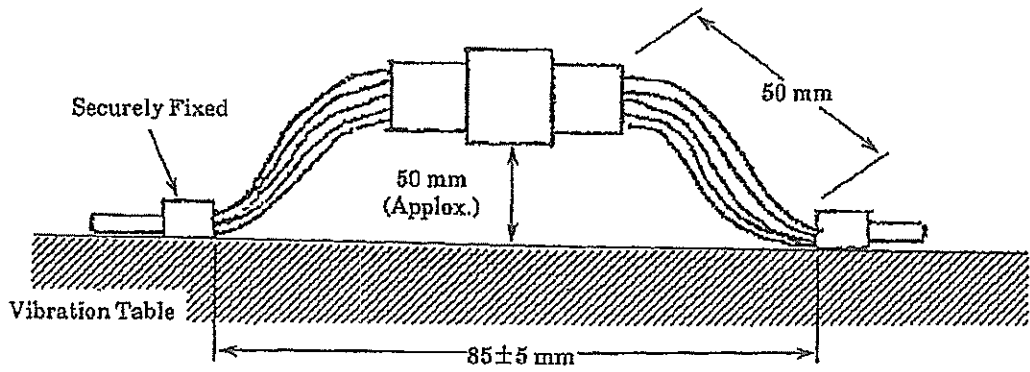

Fig. 4

SHEET	Tyco Electronics			
7 OF 8	LOC J	LOC A	NO. 108-5319	REV. D1
NAME 3-Position, 250 Series, Tab Receptacle Interlock Connector				

108-5319

NUMBER:

CUSTOMER  
RELEASESECURITY  
CLASSIFICATION:

## 3. Reference Data :

## (1) Test Conditions :

Unless otherwise specified, all the tests shall be performed in any combination of the following test conditions.

Temperature : 15-35 °C

Relative Humidity : 45-75 %

Atmospheric Pressure: 650-800 mmHg

## (2) Test Specimens :

All the wires to be used for testing shall be conforming to the following requirements. No sample shall be reused for test, unless otherwise specified.

Nominal	No. of Conductors Dia- meter of a Conductor	Calculated Cross- sectional Area (mm <sup>2</sup> )	Insulation Diameter (mm)
0.3	17/0.16	0.95	1.8 Standard
0.5	21/0.18	0.53	1.8 Standard
0.75	34/0.18	0.86	2.1 Standard
1.25	26/0.26	1.38	2.5 Standard
1.25	50/0.18	1.27	3.1 Standard
2.0	41/0.26	2.17	3.8 Standard
3.0	65/0.25	3.3	4.1 Standard

\* The conductors shall be tin-plated soft annealed copper conductors.

SHEET				
8 OF 8	LOC J	LOC A	NO. 108-5319	REV. D1
NAME 3-Position, 250 Series, Tab Receptacle Interlock Connector				