

108-5111

Product Specification
250 Series FASTIN-FASTON Connectors
For Printed Circuit Board
(Preliminary)

NUMBER 108-5111

Customer Release

AMP SECURITY CLASSIFICATION

1. Scope:

This specification covers product performance requirements and test methods for "250" Series FASTIN-FASTON* Connectors of the following numbers.

2. Product Numbers and Descriptions:

170092-4	"250" Series FASTIN-FASTON Receptacle Contact
171806-2	" " " " 5-Position Plug Housing
171807-2	" " " " 5-Position Horizontal Cap Housing

3. Definition of Terms:

For the purpose of this specification, the following definition shall apply.

3.1 Contact:

An electrically conductive metallic contact member, used as a component of a connector assembly.

3.2 Housing:

An electrically insulating plastic block member for encapsulation of contact parts. Cap housing accommodates tab contacts and plug housing accommodates receptacle contacts.

3.3 Connector Assembly:

An assembly of contact-loaded housing. It either includes an assembly that contains wire-crimped contacts, or an assembly of housing and pre-loaded, built-in tab contacts and mounted on printed circuit board.

PRINT DIST

A1 Revised RFA-1974		DR	7-7-77			AMP (Japan), Ltd.		REV
A Revised RFA-1904		CHK	7-7-77			TOKYO, JAPAN		
01 Revised RFA-1481		APP	7-7-77		LOC	NO	108-5111	
0 Preliminary		SHEET		NAME		Product Specification		
LTR REVISION RECORD		DR	CHK	DATE	1 OF 13		"250" Series FASTIN-FASTON Connector for Printed Circuit Board	

4. Material and Finish:

4.1 Contact:

Contact shall be made of brass conforming to ASTM B 36, Alloy 260. Receptacle contact shall be post-tinned and tab contact that is molded in cap housing shall be pre-tinned.

4.2 Housing:

Housing shall be made of black, heat-resistant molded 6-6 NYLON resin.

5. Product Design, Construction and Dimensions:

5.1 Receptacle Contact:

Product design, construction and dimensions shall be conforming to the applicable customer product drawing(s). Receptacle contact is a female contact whose feature shall be functionally suitable for contact termination in housing and is securely locked in position by means of locking lance, as so designated.

5.2 Plug Housing:

Product design, construction and dimensions shall be conforming to the applicable customer product drawing(s). Plug housing shall have a suitable feature to mate with cap housing, and provided with a housing lance which locks receptacle contact in position, and a locking leg which locks mated cap housing in position.

5.3 Cap Housing:

Product design, construction and dimensions shall be conforming to the applicable customer product drawing(s). Cap housing contains molded, built-in tab contacts to make a connector assembly, and provided with a pair of flanges for screw-on mounting on printed circuit board or panel, and polarizing mechanism to prevent mismatching with plug housing.

6. Temperature Rating and Board/Wire Sizes:

6.1 Temperature Rating:

Temperature rating for this product shall be within the range of -40 to +130°C.

6.2 Thickness of Applicable Printed Circuit Board:

Thickness of applicable printed circuit board shall be 1.6 ±0.15 mm.

6.3 Applicable Wire Size:

The wires of the following sizes shall be used for termination.

Cross-sectional Area of Conductor(s): 0.75 - 2.27mm (AWG # 18 - 14)
 Insulation Diameter: 2.4 - 3.4 mm (.094" - .134")

SHEET				AMP (Japan), Ltd. TOKYO, JAPAN	
2 OF 13				LOC	NO
		J	A	108-5111	A1
NAME Product Specification					
"250" Series FASTIN-FASTON Connector for Printed Circuit Board					

NUMBER 108-5111
 Customer Release
 SECURITY CLASSIFICATION

7. Performance Requirements and Test Methods:

7.1 Performance Requirements:

When tested in accordance with the test methods specified in Para. 7.2, and the test sequence specified in Para. 7.3, product performance shall meet the requirements specified in Table 1.

Test Items	Para-graph Number	Contact Performance Requirements			Connector Performance Requirements	
		Initial			Initial	After Durability & Environmental Conditioning
Appearance	7.2.1	No evidence of defects, such as cracks, breakage, damage, loose of parts, rust and fusion that are detrimental to connector functions, shall be present.				
Contact or Connector Mating Force	7.2.2	2.9N 15.7N			91.8N max. (10 kgf) max.	
Contact or Connector Extraction Force	7.2.3	(0.3 - 1.6 kgf)			14.7N - 98.1N (1.0 - 1.5 kgf)	
Low Level Resistance	7.2.4	—//—			3 mΩ max.	6 mΩ max.
Termination Resistance	7.2.5	—//—			3mV/A max.	6mV/A max.
Handling Touch at Insertion/Extraction	7.2.6	No difficulty nor abnormalities detrimental to insertion/extraction strokes shall be found.				
Insulation Resistance	7.2.7	—//—			100MΩ min.	
Dielectric Strength	7.2.8	—//—			No abnormalities shall be evident under test potential at 1,800V for 1 minute.	
Current Leakage	7.2.9	—//—			3 mA max.	
Contact Retention Force	7.2.10				58.9N min. (6 kgf) min.	
Crimp Tensile Strength (minimum)	7.2.11	mm ²	N	(kgf)	—//—	
		0.85	128N	(13kgf)		
		1.25	177N	(18kgf)		
		2.0	265N	(27kgf)		
Housing Retention Force	7.2.12				98.1 N min. (10 kgf) min.	
Current Cycling	7.2.13					
Repeated Insertion & Extraction	7.2.14	—//—				
"Kojiri" Resistibility	7.2.15					
Heat Resistibility	7.2.16					
Cold Resistibility	7.2.17					
Thermal Shock	7.2.18					
Humidity (Steady State)	7.2.19					
Vibration(High Frequency)	7.2.20					
Vibration(Low Frequency per SAE J 577)	7.2.21					

When tested in accordance with test sequence specified in Table 4, product performance characteristics shall be conforming to the requirements after durability and environmental conditioning.

Table 1

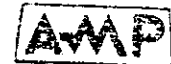
SHEET 3 OF 13

 AMP (Japan), Ltd. TOKYO, JAPAN
 LOC J A NO 108-5111 REV A1
 NAME Product Specification "250" Series FASTIN_FASTON Connector for Printed Circuit Board

7.2 Test Methods:

7.2.1 Appearance:

Products shall be visually and tactually inspected for conformance of specified design feature construction and dimensions, and checked for presence of abnormalities such as cracks, breakage, damage, loose of parts, rust, fusion and deformation detrimental to connector functions.

7.2.2 Contact or Connector Insertion Force:

After fastening a pair of unmated contacts or connectors on the head of tensile testing machine so as to be ready for mating, and apply an axial push-in load to mate them by operating the head to travel with the speed at a rate of 100mm per minute. The force required for mating shall be measured. For this test, connector locking device shall be set in effect.

7.2.3 Contact or Connector Extraction Force:

After fastening a pair of mated contacts or connector assemblies on the head of tensile testing machine so as to be ready for unmating, and apply an axial pull-off load to unmate them by operating the head to travel with the speed at a rate of 100mm per minute. The force required for unmating shall be measured. For this test, connector locking device shall not be set in effect.

7.2.4 Low Level Resistance:

Mated pair of contacts or connector assemblies shall be tested by applying closed circuit current of 50mA maximum at open circuit voltage of 50mV maximum. Measurement of millivolt drop across the testing points shall be made by probing each circuit at the point 75mm apart from the wire crimp, (across the points Y - Y' in Fig. 1). Low level resistance shall be calculated from the measured value after deducting the resistance of the crimped wire of 75mm in length.

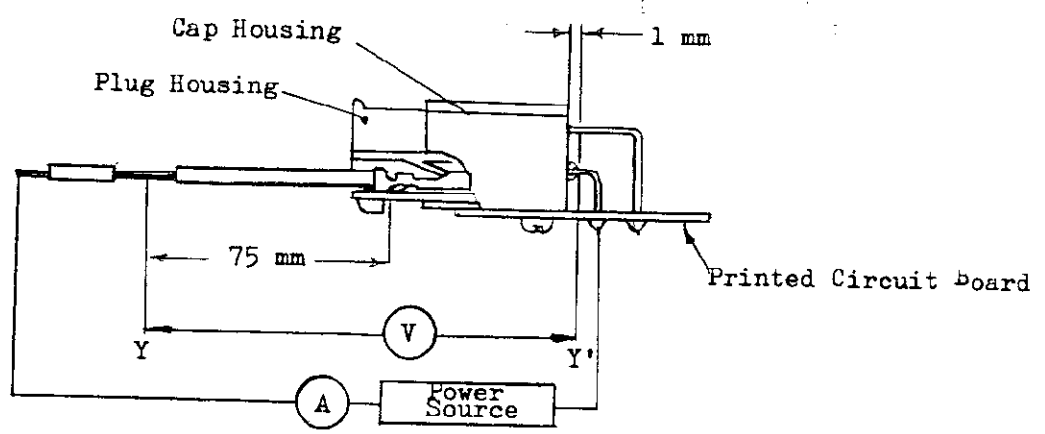

Fig. 1

SHEET	AMP		AMP (Japan), Ltd. TOKYO, JAPAN	
4 OF 13	LOG	NO	REV	
	J	A	108-5111	A1
NAME Product Specification "250" Series FASTIN-FASTON Connector for Printed Circuit Board				

7.2.5 Termination Resistance:

Mated pair of contacts or connector assemblies shall be tested for termination resistance, by applying closed circuit current of 1 A. at open circuit voltage of 12 V. flowing through the circuit. Measurement shall be done after temperature rising of the circuit by energized current becomes stabilized, by probing the circuit one after one at the points 75mm apart from the wire crimp (across the points Y - Y' in Fig. 1). Termination resistance shall be cauculated from the measured values after deducting the resistance of the 75mm long crimped wire.

7.2.6 Handling Touch of Contacts at Insertion and Extraction:

By repeating insertion and extraction of the mated pair of contacts both with or without connector housing, inspect to confirm if any tactual difficulties or abnormalities are present at insertion and extraction strokes.

7.2.7 Insulation Resistance:

Mated pair of connector assemblies shall be tested for insulation resistance by applying test potential of 500 V DC across the adjacent contacts and the contacts and the ground, after contacts are wired to form a circuit as shown in Fig. 2.

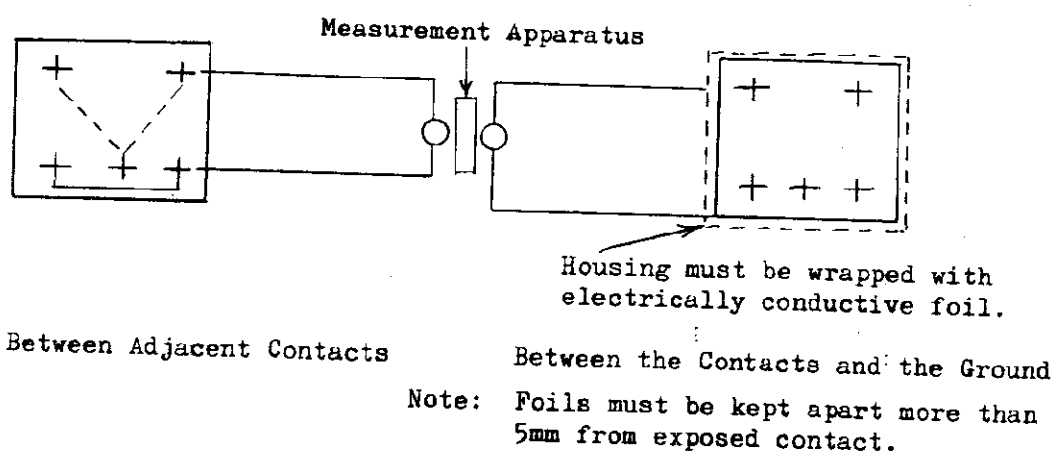

Fig. 2 Termination Resistance Test Circuit

7.2.8 Dielectric Strength:

Dielectric strength of the mated pair of connector assemblies shall be tested by applying test potential of 1,800 V AC in commercial frequency across the adjacent contacts and the contacts and the ground. The potential must be raised at a rate of 500V a second, and maintain at the specified voltage for 1 minute after specified potential is reached.

SHEET	AMP		AMP (Japan), Ltd TOKYO, JAPAN	
5 OF 13	LOC J	NO A	108-5111	REV A1
NAME Product Specification "250" Series FASTIN-FASTON Connector for Printed Circuit Board				

7.2.9 Current Leakage:

After conditioning in the test chamber for 1 hour where the temperature of $60 \pm 5^{\circ}\text{C}$ at relative humidity of 90 - 95% is maintained, take out the connector sample from the test chamber and recondition in the room temperature. The sample connector assembly shall be then tested for current leakage by energizing test potential of 12 V DC across the adjacent contacts wired as shown in Fig. 3 below.

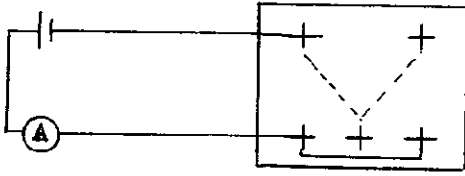

Fig. 3 Current Leakage Test Circuit

7.2.10 Contact Retention Force:

A 100mm long 0.85mm^2 wire crimped contact shall be loaded in housing cavity and locked rightly in position. The connector assembly shall be fastened on the head of tensile testing machine, and measured for contact retention force by applying an axial pull-off load on the contact by operating the head to travel at a rate of 100 mm per minute. Contact retention force is determined when the contact is pulled out from the locked position or the wire is broken.

7.2.11 Crimp Tensile Strength:

A 100mm long wire crimped contact shall be tested for crimp tensile strength, in the manner that the sample lead is fastened on the head of tensile testing machine, and by operating the head to travel at a rate of 100mm per minute, apply an axial load to pull off the wire. Crimp tensile strength is determined when the wire is broken or is pulled out from the wire crimp.

7.2.12 Housing Retention Force:

Mated pair of connector assemblies shall be fastened on the head of tensile testing machine with the locking device set in effect, and measured for housing retention force by operating the head uniformly with the speed at a rate of 100mm per minute. Housing retention force is determined when the connector halves are separated as a result of loose-off or breakage of locking device of the connector assemblies.

SHEET			AMP (Japan), Ltd. TOKYO, JAPAN	
6 OF 13	LOC	NO	REV	
	J	A	108-5111	A ₁
NAME Product Specification				
"250" Series FASTIN-FASTON Connector for Printed Circuit Board				

7.2.13 Current Cycling:

Contact loaded and mated pair of connector assemblies shall be tested for 200 cycles of current cycling test by applying test current calculated in accordance with Table 2. One cycle of current loading consists of energizing the circuit for 45 minutes with off-load intervals of 15 minutes taken between the energizing repetitions. The test shall be conducted in a draft-free test chamber.

Table 2 - 1

Wire Size mm ²	(AWG)	Amperes (A) DC
0.5	(#20)	11.0
0.85	(#18)	14.5
1.25	(#16)	18.5
2.0	(#14)	25.0

Basic Current Intensity

Table 2 - 2

Number of Positions	Reduction Coefficient
1	1
2 - 3	0.75
4 - 5	0.6
6 - 8	0.55
9 - 12	0.5
13 & Over	0.4

Reduction Rate in Accordance with Number of Positions Engaged for Test

Tables 2

Note: Intensity of test current is dependent upon the number of contact positions engaged for the test. First, obtain basic value from Table 2-1. This value must be multiplied by the reduction coefficient in Table 2-2, that is corresponding with the number of contact positions used for the test.

7.2.14 Repeated Insertion/Extraction:

Fasten a pair of connector assemblies on the head of tensile testing machine and apply repeated cycles of axial load to mate and unmate the connector assemblies for 50 cycles, by operating the head to travel with the speed at a rate of 100mm per minutes.

7.2.15 "Kojiri" Resistibility:

One half of mating pair of connector assemblies shall be secured on the table of testing machine as shown in Fig. 4, and apply one cycle each of 20 kg/cm (T) forcing load to the free-sided connector in reciprocated strokes of front-rear direction, perpendicular to contact mating axis, at every 1 mm depths of contact extraction travel, until the assemblies become fully separated. After completion of front-rear "Kojiri" forcing, repeat forcing in the same way except right-left direction this time. These coupled series of force conditionings make one cycle of the test, and repeat 10 cycles to complete the specified force conditioning.

Note: "Kojiri" is a Japanese term, meaning the motions to give forcing stress to the connector halves or a pair of contacts when mating and unmating in such manner as twisting, bending and rolling in the directions amiss to the contact axis, resulting detrimental effects of the concerned parts, especially deformation of female contacts.

SHEET	AMP		AMP (Japan), Ltd. TOKYO, JAPAN	
7 OF 13	LOC J	NO A	108-5111	REV A
NAME Product Specification "250" Series FASTIN-FASTON Connector for Printed Circuit Board				

7.2.16 Heat Resistibility:

Mated pair of connector assemblies shall be exposed under the heat at +130°C in the test oven for 2 hours. After completion of test conditioning, the assemblies shall be cooled in the room temperature, and measurement shall be made for specified test items.

7.2.17 Cold Resistibility:

Mated pair of connector assemblies shall be exposed in the cold atmosphere in the test chamber for 2 hours, where temperature of -40°C is maintained. After test exposure, connector assemblies shall be reconditioned in the room temperature, and measurement shall be made for specified test items.

7.2.18 Thermal Shock:

Mated pair of connector assemblies shall be subject to 5 cycles of thermal shock conditioning, --- one cycle as specified in Table 3 below. After completion of thermal shock exposure, the connector assemblies shall be reconditioned in the room temperature, and measurement for specified test items shall be made.

Test Sequence	Test Condition
1	130 ±5°C for 30 minutes
2	Room temperature for 5 minutes maximum
3	-40 ±5°C for 30 minutes
4	Room temperature for 5 minutes maximum

Table 3

7.2.19 Humidity:

Contact-loaded and mated pair of connector assemblies shall be subject to humidity exposure for 48 hours in the test chamber, where relative humidity of 90 - 95% at the temperature of 60 ±5°C is maintained. The connector circuit shall be terminated to form the test circuit in accordance with Fig. 3 and energized with test current at 28V DC during the test. After completion of test duration, the connector assemblies shall be taken out of the chamber and reconditioned in the room temperature. Then, measurement for specified test items shall be made.

SHEET			AMP (Japan), Ltd. TOKYO, JAPAN
8 OF 13	LOC J	A	NO 108-5111
NAME		REV. A)	
Product Specification "250" Series FASTIN-FASTON Connector for Printed Circuit Board			

7.2.20 Vibration (High Frequency):

Mated pair of connector assemblies shall be fastened tightly on the testing table of vibration testing machine as shown in Fig. 5. With all contacts series wired, the circuit shall be energized with closed circuit current of 1 A. at open circuit voltage of 12 V flowing through the circuit. The table shall be vibrated for 8 hours in accelerated magnitude of $44m/S^2$ (45G) in the sweeping frequency travelling between 20 and 200 Hz. a cycle a minute. During the test, the circuit shall be monitored for occurrence of electrical discontinuity greater than 1 microsecond, by using a proper apparatus which is pre-set at low level of 1 V/A for indication of voltage drop.

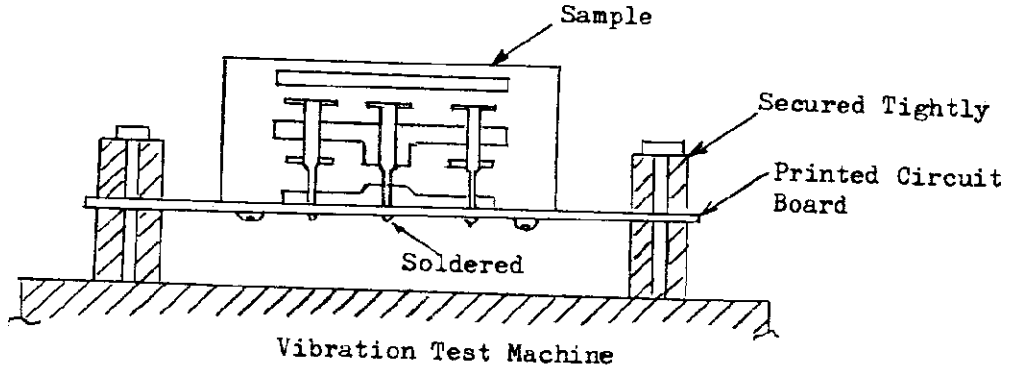

Fig. 5

7.2.21 Vibration (Low Frequency per SAE J 577):

Mated pair of connector assemblies shall be fastened tightly on the vibrating shock testing machine in accordance with SAE J 577 as shown in Fig. 5. The test shall be conducted for 1 hour by rotating shock actuating cam to shake sample laden test table at 750Hz with pre-set tooth drop depth of 3.2mm. The test table shall be supported by tension springs which are adjusted to pull up the table on working face of the cam by the pressure of 27 - 32 kg. All the contacts in the connector assemblies shall be series wired and energized with closed circuit current of 1 A at open circuit voltage of 12 V DC flowing through the circuit during the test. The test circuit shall be monitored for occurrence of electrical discontinuity greater than 1 microsecond during the test, by using proper apparatus whose voltage drop indication level shall be pre-set at 1 V/A.

SHEET	AMP		AMP (Japan), Ltd. TOKYO, JAPAN	
9 OF 13	LOC J	A	NO 108-5111	REV A ₁
NAME Product Specification "250" Series FASTIN-FASTON Connector for Printed Circuit Board				

108-5111

NUMBER

Customer Release

AMP SECURITY CLASSIFICATION

7.3 Test Sequence:

All the tests shall be conducted in accordance with the test sequence specified in Table 4 below.

Testing Items	Connector Test Sequence												
	Sample Group I						Sample Group II			Sample Group III			
Appearance	1												1
Contact or Connector Insertion Force	2								3				
Contact or Connector Extraction Force	8												
Low Level Resistance	3	11	15	18	22	25	28	31	1	5	7		
Termination Resistance	4	12	16	19	23	26	29	32					
Handling Touch at Insertion/Extraction								33					
Insulation Resistance	6												
Dielectric Strength	7	13											
Current Leakage	5												
Current Cycling										6			
Contact Retention Force								35					
Housing Retention Force								34					
Repeated Insertion/Extraction									2				
"Kojiri" Resistibility					24								
Heat Resistibility	10												
Cold Resistibility		14											
Thermal Shock				21									
Humidity (Steady State)			17										
Vibration(High Frequency)						27							
Vibration(Low Frequency) per SAE J 577							30						
Crimp Tensile Strength													2

Table 4

SHEET				AMP (Japan), Ltd. TOKYO, JAPAN	
10 OF 13		LOC	NO	108-5111	
		J	A	REV A	
NAME Product Specification "250" Series FASTIN-FASTON Connector for Printed Circuit Board					

8. Quality Assurance Provisions:

8.1 Test Conditions:

Unless otherwise specified, all the tests shall be conducted in any combination of the following conditions.

- Temperature 15 - 35°C
- Relative Humidity 45 - 75%
- Atmospheric Pressure 86.7 ~ 107 KPa
(650 - 800mmHg)

8.2 Test Specimens:

8.2.1 Sampling:

The test specimens employed for performance evaluation testing shall be normally prepared in accordance with 114-2025, Application Specification for crimping "250" Series FASTIN-FASTON Receptacles. No sample shall be reused, unless otherwise specified in this specification.

8.2.2 Number of Specimens:

Each sample group shall be consisting of 10 sets for testing contacts, and 3 sets or over for testing connector assemblies.

8.2.3 Printed Circuit Board:

The printed circuit board employed for the performance evaluation testing shall be conforming to the specification shown in Fig. 6 below.

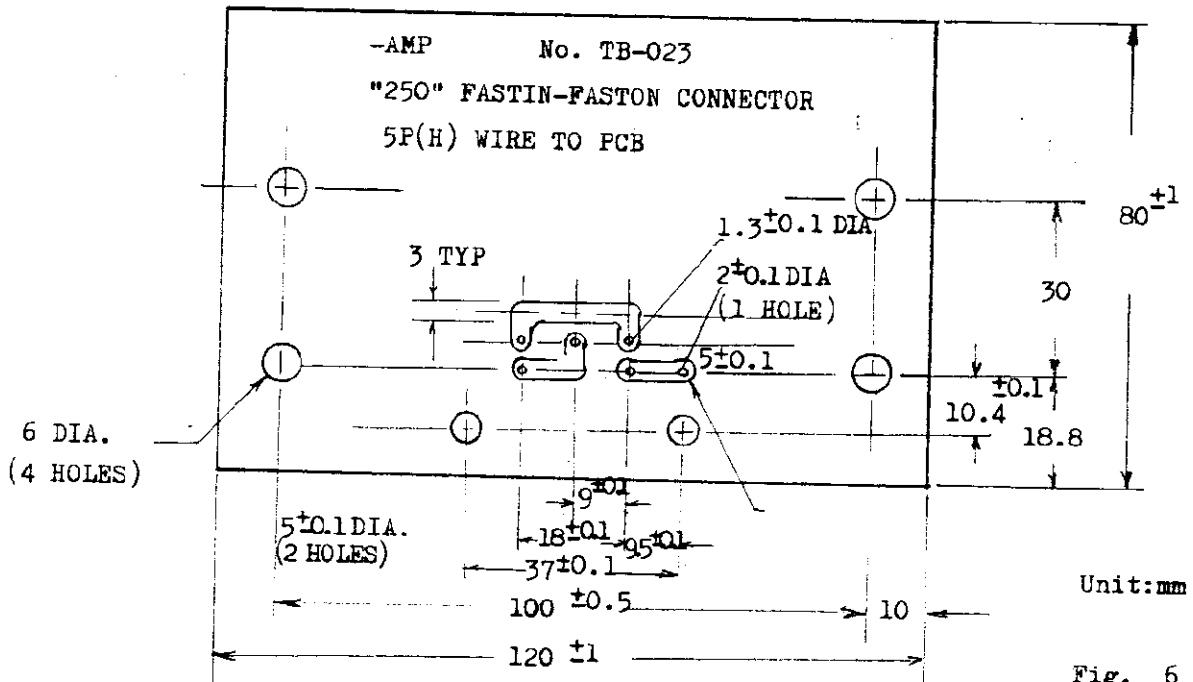

Fig. 6

Note:
 Material: Phenolic laminated paperboard, 70 μm. thickness, 1.6mm±0.15mm copper-clad one side, conforming to Class XPC of NEMA Specification
 Tolerance: ±0.2mm Unless otherwise specified.
 Finish: Tin-lead plated

SHEET	AMP		AMP (Japan), Ltd. TOKYO, JAPAN
11 OF 13	LOG J A	NO 108-5111	REV. A 1
NAME Product Specification			
"250" Series FASTIN-FASTON Connector for Printed Circuit Board			

8.2.4 Applicable Wire Size:

Wires employed for the performance evaluation testing shall be conforming to the specification in accordance with Table 5 below.

Wire Size (Nominal)		Strand Composition		Cross-sectional Area	
mm ²	(AWG)	Strand Dia. (mm)	Number of Strands	mm ²	CMA (Circular Mil Area)
0.85	(#18)	0.32	11	0.88	1746
1.25	(#16)	0.32	16	1.28	2540
2.0	(#14)	0.32	26	2.09	4128

Table 5

9. Special Instructions for Handling the Products:

9.1 Crimping:

In order to assure reliable product performance of contact retention in housing cavity and proper connector mating retention force, contacts shall be crimped in accordance with 114-2025. Application Specification, for crimping Tab and Receptacle Contacts of "250" Series FASTIN-FASTON Connectors.

9.2 Mounting Housing on PCB and its Soldering:

When to mount cap housing on printed circuit board, apply M4 tapping screws conforming to Class 1 of JIS B 1115 to secure housing in position. To retain optimum solderability of the parts, soldering operation should be done within 6 months after delivery of products.

9.3 Taping at Harness Assembly:

To avoid damages of contacts and housing by the pulling stress of bundled wire lead, the portion of wire-lead-in to housing must be kept untied to the length of 30mm minimum from the wire end of housing cavity to provide flexible adaptability by absorbing undue pull-off shock to the bundle as shown in Fig. 7.

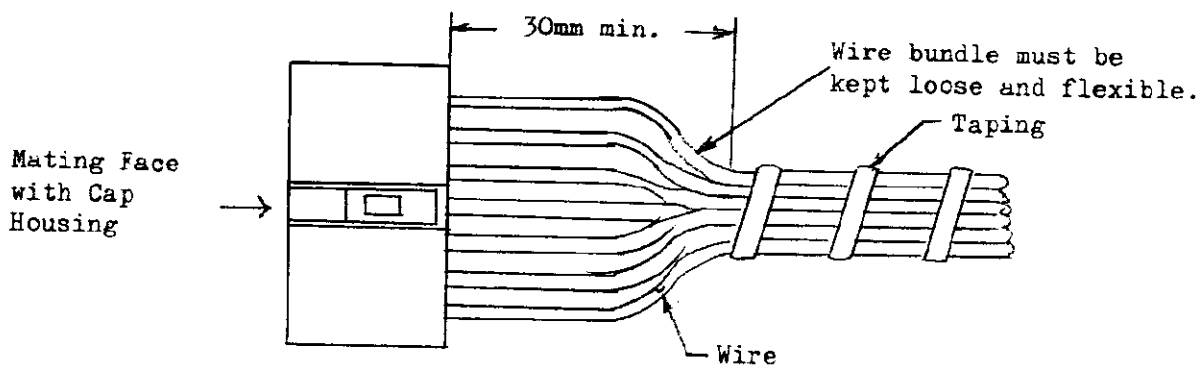

Fig. 7

SHEET	AMP		AMP (Japan), Ltd. TOKYO, JAPAN
12 OF 13	LOC J A	NO 108-5111	REV A
NAME Product Specification			
"250" Series FASTIN-FASTON Connector for Printed Circuit Board			

9.4 Application Tooling:

When to remove contacts from connector housing, use AMP recommended proper extraction tool in accordance with the procedure shown in Instruction Sheet IS-062J attached to the tool.

10. Reference Documents:

- JASO, Japanese Automobile Standard Association, and JIS, Japanese Industrial Standard, Standards
- JASO D 605-74 Multi-Connectors for Automotives (7002)
 - JASO 7101 Testing Method of Molded Plastic Parts for Automobile
 - JIS C 3406 Low-Voltage Cable for Automobile
 - JIS D 0203 Method of Moisture, Rain and Spray Test for Automobile Parts
 - JIS D 0204 Method of High and Low Temperature Test for Automobile Parts
 - JIS D 1601 Vibratile Testing Method for automobile Parts
 - JIS D 5500 Lighting and Signalling Equipment for Automobiles

SHEET				AMP (Japan), Ltd. TOKYO, JAPAN	
<u>13</u> OF <u>13</u>				LOC	NO
		J	A	108-5111	A
NAME Product Specification					
"250" Series FASTIN-FASTON Connector for Printed Circuit Board					