

TSYS01-FAMILY

Digital Temperature Sensors

SPECIFICATIONS

- ◆ **High Accuracy Temperature Sensor**
 - ◆ TSYS01: $\pm 0.1^{\circ}\text{C}$ @ Temp.: $-5^{\circ}\text{C} \dots +50^{\circ}\text{C}$
 - ◆ TSYS01-1: $\pm 0.1^{\circ}\text{C}$ @ Temp.: $-20^{\circ}\text{C} \dots +70^{\circ}\text{C}$
- ◆ **16/24 bit ADC¹ Resolution**
- ◆ **Low Power**
- ◆ **SPI²/I²C³ Interface**
- ◆ **QFN⁴16 Package**

The TSYS01 is a single device Temperature Sensing System (TSYS). The TSYS01 provides factory calibrated temperature information. It includes a temperature sensing chip and a 24-bit $\Delta\Sigma$ -ADC. The essence of the digital 24-bit temperature value and the internal calibration values lead to highly accurate temperature information accompanied by high measurement resolution.

The TSYS01 can be interfaced to any microcontroller by an I²C or SPI interface. This microcontroller has to calculate the temperature result based on the ADC values and the calibration parameters.

The basic operating principle is:

- ◆ Converting temperature into digital 16/24 bit ADC value
- ◆ Providing calibration coefficients
- ◆ Providing ADC value and calibration coefficients by SPI or I²C interface.

¹ Analog to Digital Conversion

² Serial Peripheral Interface

³ Inter-Integrated Circuit

⁴ Quad Flat No-leads

FEATURES

High Accuracy

TSYS01: $\pm 0.1^{\circ}\text{C}$ @ Temp.: $-5^{\circ}\text{C} \dots +50^{\circ}\text{C}$

TSYS01-1: $\pm 0.1^{\circ}\text{C}$ @ Temp.: $-20^{\circ}\text{C} \dots +70^{\circ}\text{C}$

Adjustment of high accuracy temp. range on request

Low Current, $<12.5 \mu\text{A}$ (standby $< 0.14 \mu\text{A}$)

SPI / I²C Interface

Small Package: QFN16

Operating Temperature Range: $-40^{\circ}\text{C} \dots +125^{\circ}\text{C}$

APPLICATIONS

Industrial Control

Replacement of Thermistors and NTCs

Heating / Cooling Systems

HVAC

ABSOLUTE MAXIMUM RATINGS

Absolute maximum ratings are limiting values of permitted operation and should never be exceeded under the worst possible conditions either initially or consequently. If exceeded by even the smallest amount, instantaneous catastrophic failure can occur. And even if the device continues to operate satisfactorily, its life may be considerably shortened.

Parameter	Symbol	Conditions	Min	Typ	Max	Unit
Supply Voltage	V _{DD}	---	-0.3	---	+3.6	V
Operating Temperature	T _{op}	---	-40	---	+125	°C
Storage temperature	T _{stor}	---	-55	---	+150	°C
ESD rating	ESD	Human Body Model (HBM) pin to pin incl. V _{DD} & GND	-4	---	+4	kV
Humidity	Hum	---	Non condensing		---	---

OPERATING CONDITIONS

Parameter	Symbol	Conditions	Min	Typ	Max	Unit
Operating Supply Voltage	V _{DD}	Stabilized	2.2	---	3.6	V
High Accuracy Supply Voltage	V _{DD}	To achieve Acc1	3.2	---	3.4	V
Supply Current	I _{DD}	1 sample per second	---	---	12.5	μA
Standby current	I _s	No conversion, V _{DD} = 3V T = 25°C T = 85°C	---	0.02 0.70	0.14 1.40	μA μA
Peak Supply Current	I _{DD}	During conversion	---	1.4	---	mA
Conversion time	T _{CONV}		7.40	8.22	9.04	ms
Serial Data Clock SPI	F _{SCLK}		---	---	20	MHz
Serial Data Clock I ² C	F _{SCL}		---	---	400	kHz
V _{DD} Capacitor	---	Place close to the chip	---	100nF	---	---

OPERATIONAL CHARACTERISTICS

If not otherwise noted, 3.3V supply voltage is applied.

Parameter	Symbol	Conditions	Min	Typ	Max	Unit
Temp. Measurement Range	T _{RANG}	---	-40	---	+125	°C
Accuracy 1	T _{ACC1}	TSYS01 -5°C < T < +50°C V _{DD} = 3.2V – 3.4V	-0.1	---	+0.1	°C
		TSYS01-1 -20°C < T < +70°C V _{DD} = 3.2V – 3.4V				
Accuracy 2	T _{ACC2}	-40°C < T < +125°C V _{DD} = 3.2V – 3.4V	-0.5	---	+0.5	°C
Power Supply Reject Ratio	PSRR	V _{DD} = 2.7 – 3.6 T = 25°C, C = 100nF	---	---	0.2	°C
Temperature Resolution	T _{RES}	---	---	---	0.01	°C
Time Constant	T _{liquid}	t ₆₃ (t ₁ → t ₂) t ₁ = 25°C (air 0m/s) t ₂ = 75°C (liquid) PCB 900mm ² x 1.5mm FR4	---	3	---	s
	T _{air}	t ₆₃ (t ₁ → t ₂) t ₁ = 25°C (air 0m/s) t ₂ = 75°C (air stream 60m/s) PCB 900mm ² x 1.5mm FR4	---	4	---	s
Self Heating	SH ₁	10 samples/s, 60s, still air	---	---	0.02	°C

ANALOGUE TO DIGITAL CONVERTER

Parameter	Symbol	Conditions	Min	Typ	Max	Unit
Output Word	---	---	24			bit
Conversion Time	t _c	---	7.40	8.22	9.04	ms

DIGITAL INPUTS (SCLK, SDI, CSB, PS)

Parameter	Symbol	Conditions	Min	Typ	Max	Unit
Input High Voltage	V _{IH}	V _{DD} = 2.2...3.6V	0.7•V _{DD}	---	V _{DD}	V
Input Low Voltage	V _{IL}	V _{DD} = 2.2...3.6V	0.0•V _{DD}	---	0.3•V _{DD}	V
CS ⁵ low to first SCLK ⁶ rising	t _{CSL}	---	21	---	---	ns
CS high to first SCLK rising	t _{CSH}	---	21	---	---	ns
SDI ⁷ setup to first SCLK rising	T _{DSO}	---	6	---	---	ns
SDI hold to first SCLK rising	T _{DO}	---	6	---	---	ns

DIGITAL OUTPUTS (SDA, SDO)

Parameter	Symbol	Conditions	Min	Typ	Max	Unit
Output High Voltage	V _{OH}	I _{Source} = 1mA	0.8•V _{DD}	---	V _{DD}	V
Output Low Voltage	V _{OL}	I _{Sink} = 1mA	0.0•V _{DD}	---	0.2•V _{DD}	V
SDO ⁸ setup to first SCLK rising	t _{QS}	---	10	---	---	ns
SDO hold to first SCLK rising	t _{QH}	---	0	---	---	ns

⁵ Chip Select

⁶ Serial Clock

⁷ Serial Data Input

⁸ Serial Data Output

CONNECTION DIAGRAM

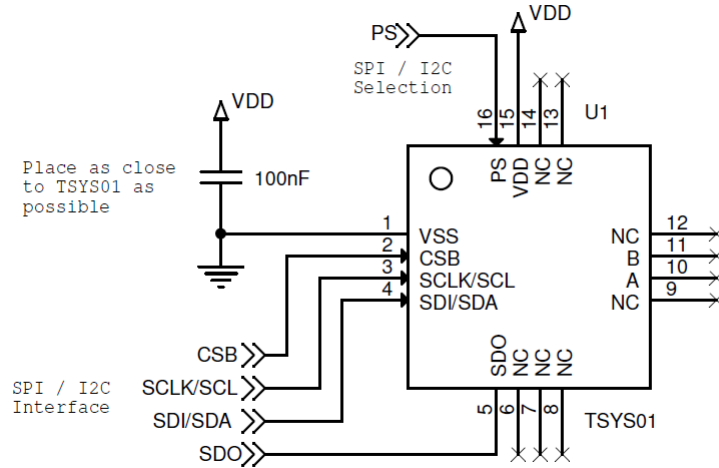

PIN FUNCTION TABLE

Pin	Name	Type	Function
1	V _{SS}	G	Ground
2	CSB	DI	SPI: Chip Select (active low) I ² C: Address Selection
3	SCLK/SCL ⁹	DI	SPI: Serial Data Clock I ² C: Serial Data Clock
4	SDI/SDA ¹⁰	DIO	SPI: Serial Data Input I ² C: Data Input / Output
5	SDO	DO	SPI: Serial Data Output
6 – 14	NC	---	Not connected / Do not connect
15	V _{DD}	P	Supply Voltage
16	PS	DI	Communication protocol select (0=SPI, 1=I ² C)
---	DAP	---	Die Attach Pad, suggested to connect to V _{SS}

⁹ Serial Clock Line

¹⁰ Serial Data Line

INTERFACE DESCRIPTION

PROTOCOL SELECTION

PS pin input level has to be defined in dependence to protocol selection.

- ◆ PS = 0 activates SPI.
- ◆ PS = 1 activates I2C.

I²C INTERFACE

A I²C communication message starts with a start condition and it is ended by a stop condition. Each command consists of two bytes: the address byte and command byte.

I²C ADDRESS SELECTION

The I²C address can be selected by CSB pin.

- ◆ CSB=1 the address is 1110110x.
- ◆ CSB=0 the address is 1110111x.

Therefore, two TSYS01 can be interfaced on the same I²C bus.

SPI INTERFACE

The serial interface is a 4-wire SPI bus, operating as a slave. CS (chip select), SCLK (serial clock), SDI (serial data in), and SDO (serial data out) are used to interact with the SPI master.

Communication with the chip starts when CS is pulled to low and ends when CS is pulled to high.

SCLK is controlled by the SPI master and idles low (SCLK low on CS transitions, mode 0).

A mode where the clock alternatively idles high is also supported (mode 3).

COMMANDS

The commands are the same for SPI and I²C interface.

There are four commands:

- ◆ Reset
- ◆ Read PROM (calibration parameters)
- ◆ Start ADC Temperature conversion
- ◆ Read ADC Temperature result

Command	Hex Value
Reset	0x1E
Start ADC Temperature Conversion	0x48
Read ADC Temperature Result	0x00
PROM Read Address 0	0xA0
PROM Read Address 1 (Coefficient k ₄)	0xA2
PROM Read Address 2 (Coefficient k ₃)	0xA4
PROM Read Address 3 (Coefficient k ₂)	0xA6
PROM Read Address 4 (Coefficient k ₁)	0xA8
PROM Read Address 5 (Coefficient k ₀)	0xAA
PROM Read Address 6 (SN _{23...8})	0xAC
PROM Read Address 7 (SN _{7...0} and Checksum)	0xAE

RESET SEQUENCE

The Reset sequence has to be sent once after power-on. It also can be used to reset the device ROM from an unknown condition.

SPI

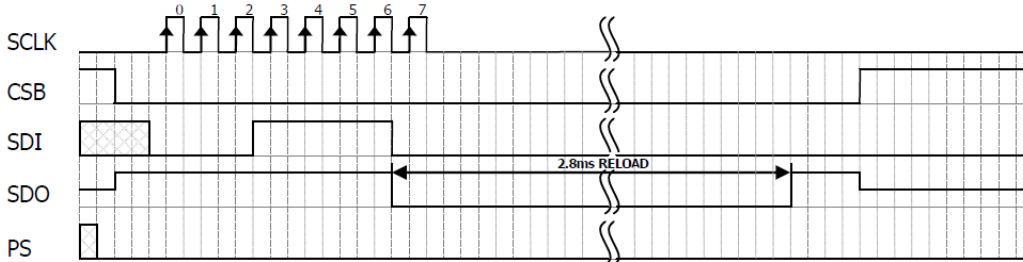

I²C

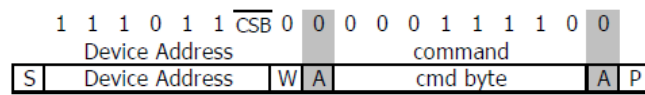

From Master S = Start Condition W = Write A = Acknowledge
 From Slave P = Stop Condition R = Read N = Not Acknowledge

PROM READ SEQUENCE

The PROM Read command consists of two parts. First command sets up the system into PROM read mode. The second part gets the data from the system.

Below examples are sequences to read address 3 (command 0xA6).

SPI

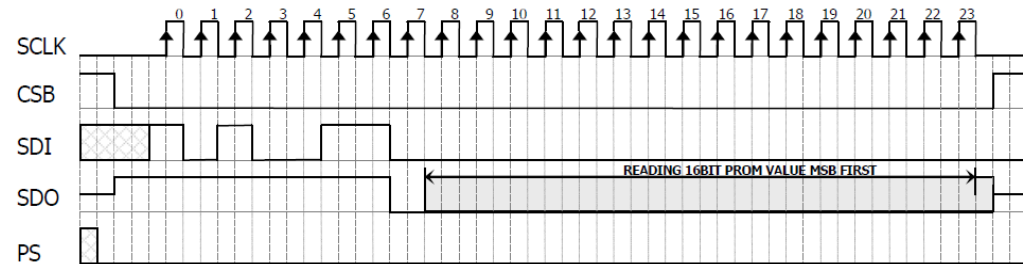

I²C

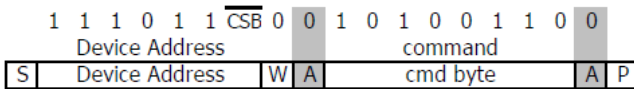

From Master S = Start Condition W = Write A = Acknowledge
 From Slave P = Stop Condition R = Read N = Not Acknowledge

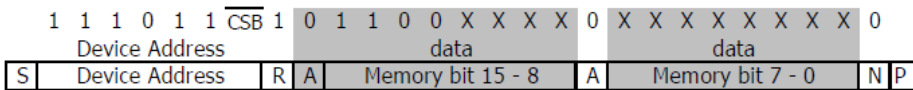

From Master S = Start Condition W = Write A = Acknowledge
 From Slave P = Stop Condition R = Read N = Not Acknowledge

CONVERSION SEQUENCE

A conversion has to be started by sending this command. The sensor stays busy until conversion is done. When conversion is finished the data can be accessed by using ADC read command

SPI

The last clock will start the conversion which TSYS01 indicates by pulling SDO low. SDO goes high when conversion is completed.

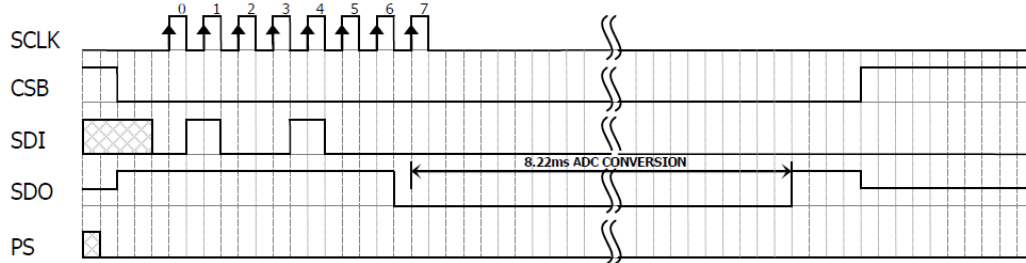

I²C

When the command is sent the TSYS01 stays busy until the conversion is done. All other commands except the reset command will not be executed during this time. When the conversion is finished the data can be accessed by sending a ADC read command, when an acknowledge appears from TSYS01.

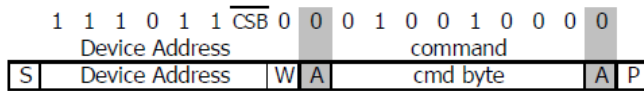

<input type="checkbox"/> From Master	S = Start Condition	W = Write	A = Acknowledge
<input checked="" type="checkbox"/> From Slave	P = Stop Condition	R = Read	N = Not Acknowledge

READ ADC RESULT

After the conversion command the ADC result is read using ADC read command. Repeated ADC read commands, or command executed without prior conversion will return all 0 as result.

SPI

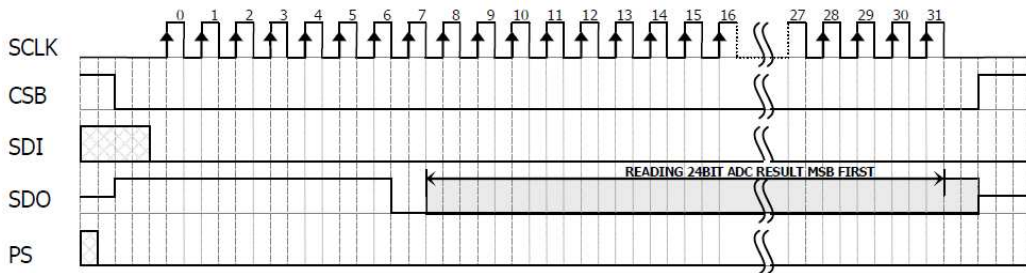

I²C

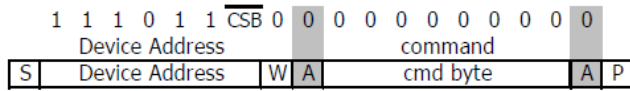

From Master S = Start Condition W = Write A = Acknowledge
 From Slave P = Stop Condition R = Read N = Not Acknowledged

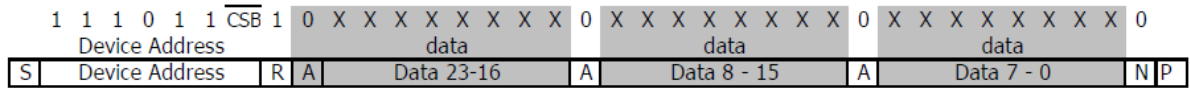

From Master S = Start Condition W = Write A = Acknowledge
 From Slave P = Stop Condition R = Read N = Not Acknowledged

TEMPERATURE CALCULATION

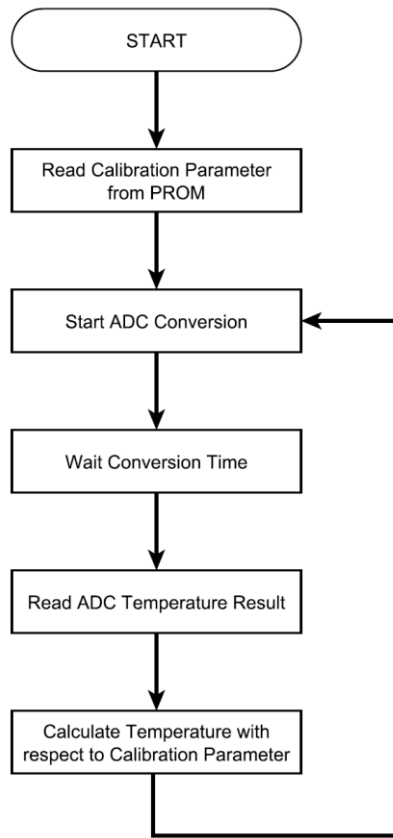

CALIBRATION PARAMETER

Variable	Description	Command	Size / bit	Min	Max	Example
k ₄	Coefficient k ₄ of polynomial	0xA2	16	0	65535	28446
k ₃	Coefficient k ₃ of polynomial	0xA4	16	0	65535	24926
k ₂	Coefficient k ₂ of polynomial	0xA6	16	0	65535	36016
k ₁	Coefficient k ₁ of polynomial	0xA8	16	0	65535	32791
k ₀	Coefficient k ₀ of polynomial	0xAA	16	0	65535	40781

TEMPERATURE POLYNOMIAL

ADC24: ADC value
 ADC16: ADC24 / 256

$$T / ^\circ\text{C} = (-2) * k_4 * 10^{-21} * ADC16^4 + 4 * k_3 * 10^{-16} * ADC16^3 + (-2) * k_2 * 10^{-11} * ADC16^2 + 1 * k_1 * 10^{-6} * ADC16 + (-1.5) * k_0 * 10^{-2}$$

EXAMPLE

ADC24: 9378708
 ADC16: 9378708 / 256 = 36636

$$T / ^\circ\text{C} = (-2) * 28446 * 10^{-21} * 36636^4 + 4 * 24926 * 10^{-16} * 36636^3 + (-2) * 36016 * 10^{-11} * 36636^2 + 1 * 32791 * 10^{-6} * 36636 + (-1.5) * 40781 * 10^{-2}$$

T / °C = 10.59

Serial number

Content / Description		Command	Size / bit	Example
Bit 16 ... 8	Bit 7 ... 0			
SN _{23...8}		0xAC	16	0x0005 (H ₀ = 0x00, L ₀ = 0x05)
SN _{7...0}	Checksum	0xAE	16	0x96D9 (H ₀ = 0x96, L ₀ = 0xD9)

Serial number = 2⁸ x SN_{23...8} + SN_{7...0}

EXAMPLE

Serial number: 2⁸ x 5 + 150 = 1430

Checksum

In order to check communication and integrity of PROM content, the PROM includes a checksum. By summarization of the complete PROM content in a byte by byte way, the verification can be performed. The lower byte of the sum result has to be 0x00.

DIMENSIONS

TOP VIEW

All dimensions shown in mm

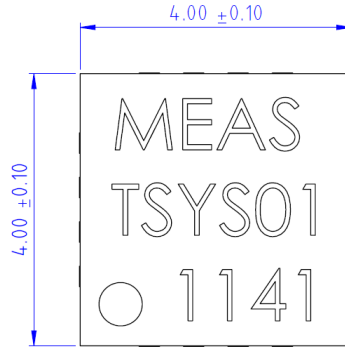

SIDE VIEW

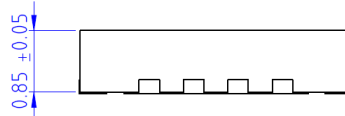

BOTTOM VIEW

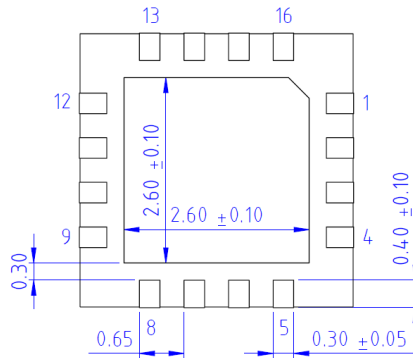

Die Attach Pad, suggested to connect to VSS

MARKING

Line	Description	Example
1	Manufacturer	MEAS
2	Product Name	TSYS01
3	Pin 1 Dot, Date Code YYWW	1141

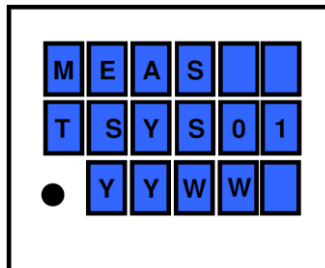

ORDER INFORMATION

Please order this product using following:

Part Number	Part Description
G-NICO-018	TSYS01 Digital Temperature Sensor
G-NICO-023	TSYS01-1 Digital Temperature Sensor

EMC

Due to the use of these modules for OEM application no CE declaration is done. Especially line coupled disturbances like surge, burst, HF etc. cannot be removed by the module due to the small board area and low price feature. There is no protection circuit against reverse polarity or over voltage implemented.

NORTH AMERICA

Measurement Specialties, Inc.
a TE Connectivity Company
Tel 800-522-6752
customercare.hmpt@te.com

EUROPE

Measurement Specialties (Europe), Ltd.,
A TE Connectivity Company
Tel 800-440-5100
customercare.dtmtd@te.com

ASIA

Measurement Specialties (China), Ltd.,
a TE Connectivity Company
Tel 0400-820-6049
customercare.shzn@te.com

TE.com/sensorsolutions

Measurement Specialties, Inc., a TE Connectivity company.

TE Connectivity, TE connectivity (logo) are trademarks. All other logos, products and/or company names referred to herein might be trademarks of their respective owners.

The information given herein, including drawings, illustrations and schematics which are intended for illustration purposes only, is believed to be reliable. However, TE Connectivity makes no warranties as to its accuracy or completeness and disclaims any liability in connection with its use. TE Connectivity's obligations shall only be as set forth in TE Connectivity's Standard Terms and Conditions of Sale for this product and in no case will TE Connectivity be liable for any incidental, indirect or consequential damages arising out of the sale, resale, use or misuse of the product. Users of TE Connectivity products should make their own evaluation to determine the suitability of each such product for the specific application.

© 2017 TE Connectivity Ltd. family of companies All Rights Reserved.